

- EN** p. 1 - 4
- ZH** p. 5 - 8
- VI** p. 9 - 12
- MS** p. 13 - 16
- TH** p. 17 - 20
- KO** p. 21 - 24

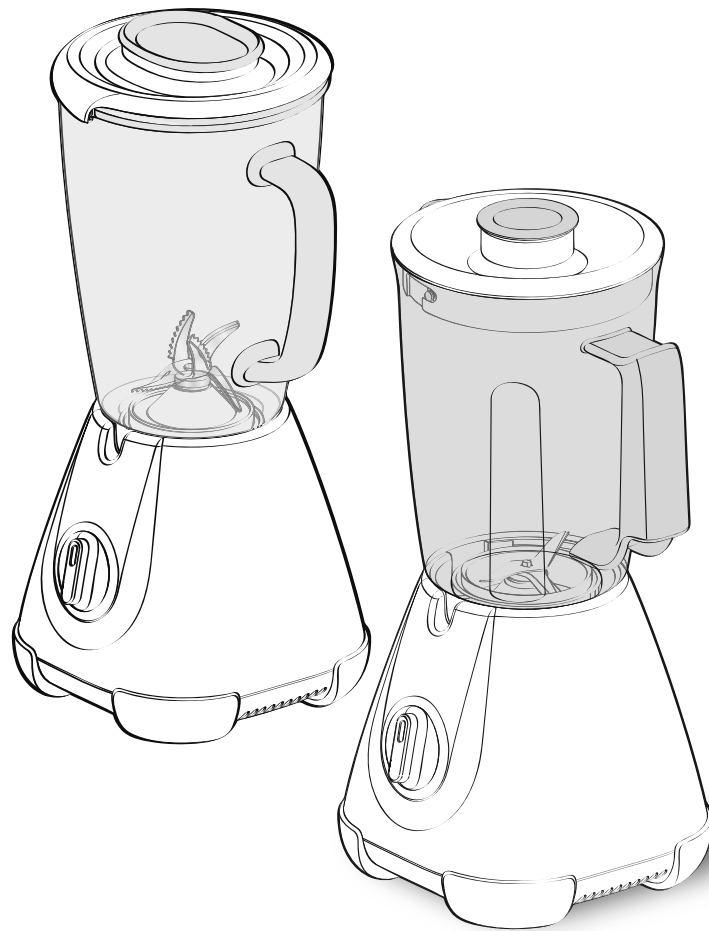

- EN**
- ZH**
- VI**
- MS**
- TH**
- KO**

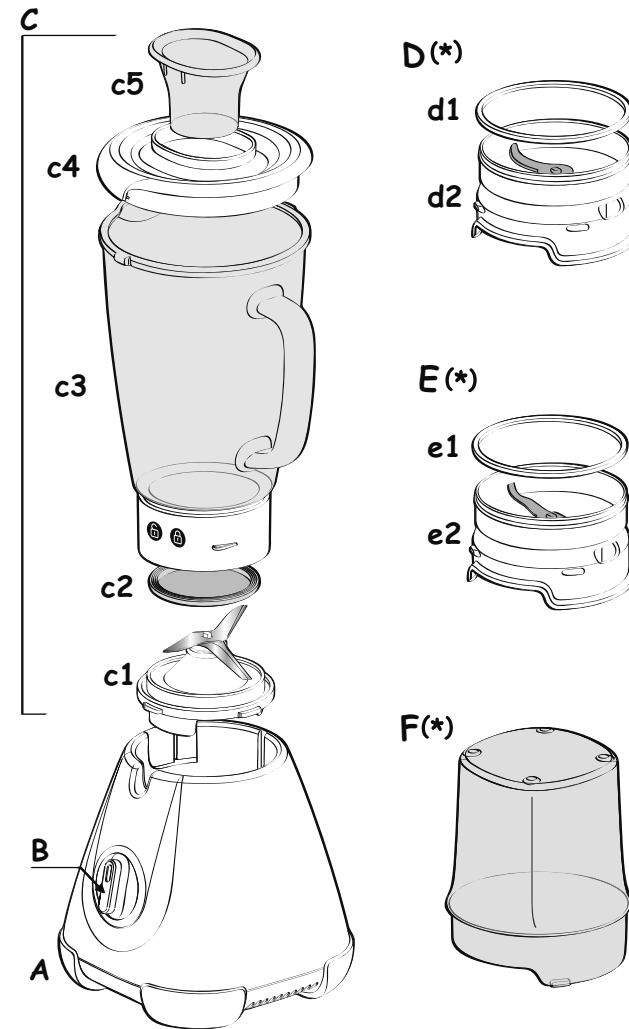

500 W - 500 วัตต์

*Blade unit depending on model - *刀片視乎型號而定 - *Cụm lưỡi dao theo model

*Pisau blok berdasarkan model - *ใบมีดของโตป็นขึ้นอยู่กับรุ่น - *모델별로 다른 칼날부

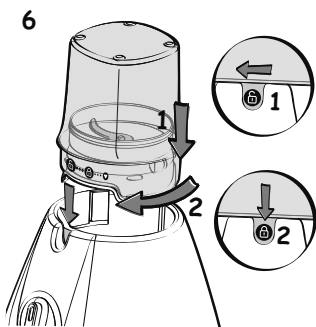
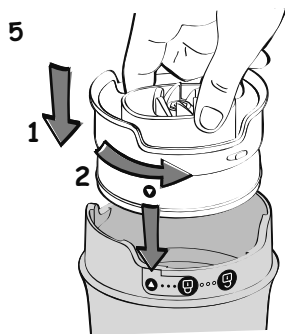
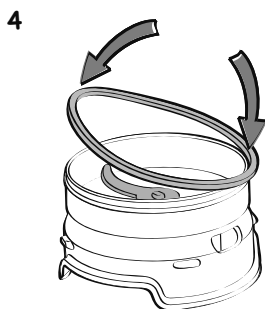
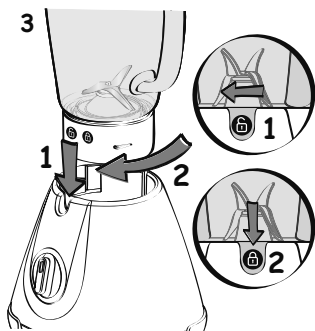
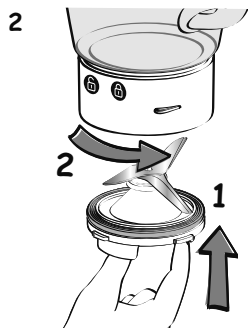
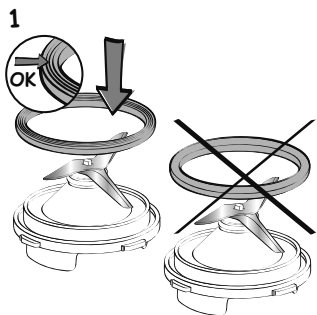

DESCRIPTION OF THE APPLIANCE

- A** Motor unit
- B** Speed selector
- C** Blender unit:
 - **c1** Blade unit
 - **c2** Gasket
 - **c3** Graduated blender jug
 - **c4** Lid
 - **c5** Measuring cup
- D** Herb chopper
 - (*accessory depending on model)
 - **d1** Gasket
 - **d2** Herb chopper blade unit
- E** Spice grinder
 - (*accessory depending on model)
 - **e1** Gasket
 - **e2** Spice blade unit
- F** Herb chopper and Spice grinder bowl

The accessories contained in the model you have bought are represented on the label on the top of the packaging.

CAUTION: the safety precautions are part of the appliance. Read them carefully before using your new appliance for the first time. Keep them in a place where you can find and refer to them later on.

SAFETY LOCKING

The appliance can run only when the jug (**C**) or accessories (**D** or **E**) are

correctly positioned and locked on the motor unit (**A**).



USING FOR THE FIRST TIME

- Before using your appliance for the first time, clean all the accessories (**C, D, E, F**) in warm soapy water, except for the motor unit (**A**).
CAUTION: The blades are extremely sharp; handle them with caution when using or cleaning the appliance.
- Make sure all the packaging has been removed before operating the appliance.
- Important note: Turn the speed selector (**B**) to "0" before placing the blender jug or accessories on the motor unit.
- The appliance starts only if the jug or accessory is correctly positioned and locked on its body.
- **Do not operate the blender if the lid is not in place.**

USING YOUR APPLIANCE

- Moisten the gasket (**c2**) and position it correctly on the blade unit (**c1**): the 3 folds of the gasket must be visible once it is in place. If it is positioned in the other direction, you will not be able to lock the blade unit on the jug. (Fig. 1).
- Place the assembly (**c1+c2**) on the

base of the jug **(c3)**. Lock it by rotating the blade unit through a quarter turn in the anticlockwise direction. (Fig. 2).

- Introduce the ingredients into the assembled jug without exceeding the maximum level indicated:
 - * **1.25L for thick mixtures**
 - * **1L for liquid preparations.**
- Lock the lid **(c4)** on the jug. Place the measuring cup **(c5)** in its recess on the lid.
- Place the blender jug assembly **(C)** on the motor unit **(A)**. The red lock (open)  is aligned in the slot on the motor unit. (Fig. 3 - position 1)
- Then rotate the blender jug **(C)** through a quarter turn until the green lock (closed)  appears. (Fig. 3 - position 2).



2 jug positions are possible: handle on the right or left of the motor unit.

- Do not use the blender for more than three minutes at a time.
- With the herb chopper **(D)** you can chop ingredients like onions, garlic, meat (cut into pieces) and dry fruits in a few seconds, make crumbs (rusk).
- Do not use the herb chopper for liquid preparations (fruit juices, etc.)
- With the spice grinder **(E)** you can grind spices in a few seconds: coriander seeds, pepper, etc.
- These accessories are equipped with a bowl **(F)** that prevents access to the blades during use.

1- Rotate the bowl **(F)** and pour the ingredients.

- 2- Position the gasket **(d1)** or **(e1)** in its recess on the blade unit **(d2)** or **(e2)**. (Fig. 4). Position the blade unit on the bowl aligning both the marks on the bowl and the blade unit. Lock the accessory by rotating the blade unit through a quarter turn in the anticlockwise direction. (Fig. 5).

Caution: leaks can occur if the accessory is not locked correctly.

- 3- Rotate the assembled assembly **(D)** or **(E)** and position it on the motor unit. The red lock (open)  is aligned in the slot on the motor unit. (Fig 6 - position 1)
- 4- Then rotate the assembled accessory **(D)** or **(E)** through a quarter turn clockwise until the green lock (closed)  appears. (Fig. 6 - position 2).
- 5- Plug in the appliance and turn the speed selector **(B)** to the desired position or apply a few pulses. Hold the bowl **(F)** when the appliance is running. To stop the appliance, turn the speed selector **(B)** back to position "0".
- 6- Unlock the accessory by rotating it through a quarter turn in the anticlockwise direction, until the red lock (open)  appears. Remove the assembled accessory **(D, E)** from the motor unit. Turn it over on the worktop before unlocking the blade unit **(d2, e2)** from the bowl **(F)** in the reverse order of the assembly. The blades are very sharp: handle them with caution to avoid injury. You can then collect the preparation in the bowl.

* The colour of the bowl may change after blending certain very hard ingredients: (cloves, cinnamon, etc.).

Ingredients	Quantities (max.)	Operating time	Accessory
Apricots / figs	60 g	3 s / speed 2	D
Crumbs	1 rusk	10 seconds per pulse	D
Onions	60 g	6 sec / speed 1	D
Shelled almonds / hazelnuts	60 g	30 seconds per pulse	D
Parsley / fresh coriander	10 g	In pulses	D
Coriander seeds	40 g	30 sec / speed 2	E

CLEANING YOUR APPLIANCE

- Unplug the appliance and remove the accessories
- Handle them with caution: the blades on the blender jug and accessories are sharp.
- Remove the jug and rinse it and its lid under running water.
- To clean the motor unit **(A)**, use a moist cloth. Dry it carefully.
- Never immerse the motor unit **(A)** in running water.
- For easy cleaning, be sure to wash the removable parts in water and a little washing-up liquid immediately after use.
- To clean the blender jug **(C)** easily, unlock the blade unit **(c1)** by rotating it through a quarter turn in the anticlockwise direction. Remove the gasket **(c2)** and clean them under running water or in the dishwasher.
- **GLASS BOWL VERSION** (depending on model):
The glass bowl **(C)** can be cleaned in the dishwasher on the upper rack - use the 'ECO' or 'LOW SALT' programme. The accessories **(D, E)** cannot be cleaned in the dishwasher.
- **PLASTIC BOWL VERSION** (depending on model):
The plastic bowl **(C)** and the accessories **(D, E)** cannot be cleaned in the dishwasher.

WHAT TO DO IF YOUR APPLIANCE DOES NOT WORK ?

Problems	Causes	Solutions
Product does not work.	The plug is not fitted correctly into the socket .	Plug the appliance into a socket and switch on.
	The jug or accessory is not correctly positioned or locked on the motor unit.	Check that the jug or accessories are correctly positioned and locked onto the motor unit as shown in the figure in the manual.
Excessive vibrations.	The product is not placed on a flat, stable, heat-resistant surface.	Place the product on a flat surface.
	Volume of ingredients is too high.	Reduce the quantity of ingredients processed.
Leak from the lid.	Volume of ingredients is too high.	Reduce the quantity of ingredients processed.
	The lid is not correctly positioned.	Lock the lid correctly on the blender jug.
Leak from the base of the blender jug.	The blender jug gasket (c2) is not positioned correctly or is missing.	Reposition the gasket and lock the blade holder correctly.
Leak from the base of the accessories.	The gasket on the blade unit (d2) or (e2) is not positioned correctly or is missing.	Reposition the gasket on the blade unit (d2) or (e2) and lock it correctly onto the bowl (F) .
The blade does not turn easily.	Pieces of food too large or too hard.	Reduce the size or quantity of ingredients processed. Add liquid
Impossible to lock the blade unit with the gasket (c1+c2) on the jug (c3) .	The gasket (c2) is not positioned correctly.	Reposition the gasket, the 3 folds should be visible as shown in Fig. 1.

Your blender still does not work?

Contact an approved service centre (see list in service booklet).

You can customise your blender and obtain the following accessories from your usual dealer or from an approved

service centre: Herb chopper accessory **(D)**, Spice grinder accessory **(E)**, or an additional blender jug **(C)**.

本設備的說明

- A** 馬達裝置
- B** 變速選擇器
- C** 攪拌器：
 - **c1** 刀片
 - **c2** 襯墊
 - **c3** 量筒攪拌器
 - **c4** 蓋子
 - **c5** 量杯
- D** 切刀
 - (*配件視機型而定)
 - **d1** 襯墊
 - **d2** 切刀裝置
- E** 磨豆器
 - (*配件視機型而定)
 - **e1** 襯墊
 - **e2** 磨研裝置
- F** 切刀與磨研碗

您所購買的機型所附的配件在包裝最上方的標籤有標示。

警告：安全說明是設備的一部份。使用新設備前，請細心閱讀。請妥善保存，以便日後作參考之用。



安全鎖

本設備只能在攪拌器**(C)**或配件**(D或E)**的位置正確並固定在馬達裝置上**(A)**才能運作。

第一次使用

- 第一次使用本設備之前，請用溫肥皂水清潔除馬達裝置(A)以外的所有配件(C, D, E, F)。
- **注意：刀片極銳利，使用或清潔本設備時請小心處理。**
- 操作本設備之前，請確定已拆下所有包裝。
- **重要事項：**將攪拌器或配件放置在馬達裝置上之前，請將變速選擇器 (B) 轉到“0”。
- 本設備僅在攪拌器或配件在主機的位置與固定正確時才會啟動。
- **不可在未蓋上蓋子時操作本攪拌器。**

使用本設備

- 將襯墊弄蓬(c2)並正確放置在刀片(c1)上：襯墊在定位時，可以看到其三個摺。如果放置在其他方向，您將無法鎖住攪拌器上的刀片。(圖1)
- 將組件(c1+c2)放在攪拌器(c3)的底座上。朝逆時針方向旋轉刀片四分之一圈將其鎖住。(圖2)
- 將材料倒入組合好的攪拌器內，但不能超過指示的最大容量：
 - * M.25L濃混合物
 - * 1L液體
- 鎖上在攪拌器上的蓋子(c4)。將量杯(c5)放在蓋子的凹槽中。
- 將攪拌器組件(C)放在馬達裝置(A)上。紅色的鎖(開啟 ) 在馬達裝置的溝槽中對齊。(圖3-位置1)
- 將攪拌器(C)旋轉四分之一圈，直到顯示綠鎖(已關閉)  為止。(圖3-位置2)

攪拌器有兩個可放置位置：馬達裝置右側或左側的手把。

- 請遵守攪拌器最長使用時間為3分鐘。
- 香草磨碎器(D)能讓你在幾秒之間磨碎蔥、蒜，把肉類切片，切乾果，及製作麵包屑。



不可使用切刀打液體(例如打果汁)

- 使用磨豆器(E)可以幾秒內研磨調味料：芫荽籽、辣椒等。
- 這些配件配備有一個防止在使用時接觸到刀片的碗(F)。

1- 將碗(F)旋轉並倒出內容物。

- 2- 將襯墊(d1)或(e1)放在刀片的凹槽中(d2或e2)。(圖4)。將刀片裝置放在與碗和刀片裝置的標記對齊的碗上。朝逆時針方向旋轉刀片四分之一圈將配件鎖住。(圖5)

注意：未正確鎖好配件可能導致外漏。

- 3- 旋轉組合後的配件(D或E)，並將其放在馬達裝置上。紅色的鎖(開啟)  在馬達裝置的溝槽中對齊。(圖6-位置1)
- 4- 將組合的配件(D或E)旋順時針方向旋轉四之一圈，直到顯示綠鎖(已關閉)  為止。(圖6-位置2)
- 5- 將本設備的電源插頭插入電源插座中，然後將變速選擇器(B)轉到想要的位置或讓攪拌器打幾下。在本設備運作時固定碗(F)。若要使本設備停止運作，請將變速選擇器(B)調回位置“0”。
- 6- 依逆時針方向將配件旋轉四分之一圈讓其解鎖，直到顯示紅鎖(開啟)  為止。從馬達裝置上取下組合的配件(D, E)。

依組合的相反順序從碗(F)上將刀片裝置解鎖時，在工作台上將它上下顛倒翻過來。刀片非常銳利：處理時請小心以避免受傷。

你可以將調配物集中在碗中。

* 碗的顏色可能在攪拌某些非常硬的內容物後變更：(目蓂、肉桂等)。

材料	最大容量	運轉時間	配件
杏仁/無花果	60 g	3秒/2速	D
麵包	1片	每時段10 秒	D
洋蔥	60 g	6秒/1速	D
剝殼的杏仁/榛果	60 g	每時段30 秒	D
荷蘭芹/新鮮的芫荽	10 g	打幾下	D
芫荽籽	40 g	30秒/2速	E

清潔本設備

- 拔下本設備的電源插頭並取下配件。
- 請小心處理：攪拌器與配件的刀片非常銳利。
- 取下攪拌器，並在流水之下沖洗它及其蓋子。
- 清潔馬達裝置(A)時，請使用溼布。小心讓它乾燥。
- 絕不可將馬達裝置(A)浸入流動的水之中。
- 為了方便清潔，請務必在使用後立即用水和一點清潔液清洗可移動零件。
- 若要方便清潔攪拌器(C)，依逆時針方向將刀片裝置旋轉四分之一圈以將其解鎖。取下襯墊(C2)，然後用流水或洗碗機清潔。
- 玻璃容器款式 (視乎型號而定)：玻璃容器 (C) 可以放於洗碗碟機的上層架並使用「節能」或「快洗」程式清洗。配件(D, E) 不應在洗碗碟機清洗。
- 塑膠容器款式 (視乎型號而定)：塑膠容器 (C) 及配件 (D, E) 不應放在洗碗碟機清洗。

本設備不操作時，我該怎麼辦？

問題	原因	解決方法
本產品不操作。	電源插頭未正確插入電源插頭中。	將本設備的電源插頭正確插入電源插頭中並開啟電源。
	攪拌器或配件在馬達裝置上的位置錯誤或未正確鎖定。	檢查攪拌器或配件在馬達裝置上的位置與鎖定是否如手冊中的圖所示一樣正確。
震動過度。	未將本產品放在平坦、穩定與耐熱的表面上。	將本產品放置在平坦表面上。
	材料容量太多。	減少所處理材料的容量。
從蓋子滲漏。	材料容量太多。	減少所處理材料的容量。
	蓋子的位置錯誤。	將蓋子正確鎖定在攪拌器上。
攪拌器的底座滲漏。	攪拌器襯墊(c2)的位置錯誤或遺失。	重新放置襯墊，然後正確鎖住刀片固定器。
配件的底座滲漏。	刀片裝置(d2)或(e2)上的襯墊位置錯誤或遺失。	重新放置刀片裝置(d2)或(e2)上的襯墊，然後將它正確鎖定在碗(F)上。
刀片無法輕易轉動。	食物碎片太大塊或太硬。	減少所處理材料的大小或容量。 加入液體
無法用攪拌器(c3)上的襯墊(c1+c2)鎖定刀片。	襯墊(c2)的位置錯誤。	重新放置襯墊，應如圖1所示能看到3個摺。

您的攪拌器仍然無法操作？

請洽詢經許可的服務中心（參閱服務手冊中的一覽表）。

您可以從您光顧的經銷商或經許可的服

務中心處訂購或取得下列配件：切刀配件 (D)、磨研配件 (E)或額外的攪拌器 (C)。

MÔ TẢ THIẾT BỊ

- A** Bộ phận động cơ
- B** Nut chọn tốc độ
- C** Bộ phận xay:
 - **c1** Bộ phận dao cắt
 - **c2** Vòng đệm
 - **c3** Bình máy xay chia độ
 - **c4** Nắp
 - **c5** Tách đo
- D** Bộ phận cắt rau củ
(*phụ kiện tùy vào mẫu máy)
 - **d1** Vòng đệm
 - **d2** Bộ phận dao cắt rau củ
- E** Bộ phận xay gia vị
(*phụ kiện tùy vào mẫu máy)
 - **e1** Vòng đệm
 - **e2** Bộ phận dao cắt gia vị
- F** Tô của bộ phận cắt rau củ và Máy xay gia vị

Phụ kiện có trong mẫu bạn đã mua được ghi trên nhãn ở mặt trên cùng của bao bì.

QUẢNG CÁO: Hướng dẫn an toàn là một phần quan trọng trong tài liệu này. Vui lòng đọc kỹ trước khi sử dụng thiết bị mới của bạn. Hãy đặt ở vị trí mà bạn có thể dễ dàng tìm thấy để tham khảo trong những lần sau.

KHÓA AN TOÀN

Thiết bị này chỉ có thể hoạt động khi bình (C) hoặc các phụ kiện (D hoặc E) được lắp

chính xác và khóa vào bộ phận động CO' (A).

SỬ DỤNG LẦN ĐẦU



- Trước khi sử dụng thiết bị của bạn lần đầu tiên, hãy vệ sinh tất cả các phụ kiện (C, D, E, F) bằng nước xà phòng ấm, trừ bộ phận động CO' (A).
- Đảm bảo đã tháo tất cả bao bì trước khi vận hành thiết bị.
- **THẬN TRỌNG: Các lưỡi dao rất sắc; hãy cầm chúng một cách thận trọng khi sử dụng hoặc vệ sinh thiết bị.**
- Lưu ý quan trọng: Vận nút chọn tốc độ (B) đến vị trí "0" trước khi đặt bình máy xay hoặc phụ kiện lên bộ phận động cơ.
- Thiết bị chỉ khởi động nếu bình này hoặc phụ kiện được lắp chính xác và khóa vào thân của nó.
- **Không được vận hành máy xay nếu chưa đầy nắp.**

SỬ DỤNG THIẾT BỊ CỦA BẠN

- Làm ấm vòng đệm (c2) và đặt nó chính xác lên bộ phận dao cắt (c1): 3 nếp gấp của vòng đệm phải nhìn thấy được sau khi lắp. Nếu nó được lắp ở hướng ngược lại, bạn sẽ không thể khóa bộ phận dao cắt vào bình. (Hình 1).
- Đặt bộ lắp ráp (c1+c2) lên bệ đỡ của bình (c3). Khóa bằng cách xoay bộ phận dao cắt một phần tư vòng ngược chiều kim đồng hồ. (Hình 2).
- Bỏ các thành phần thức ăn vào bình đã lắp ráp mà không vượt quá mức tối đa đã cho biết:

1.25L đối với hỗn hợp đặc

1L đối với các chế phẩm lỏng.

- Khóa nắp (c4) bên trên bình. Đặt tách đo (c5) vào phần thụt vào của nó trên nắp.
- Đặt bộ bình máy xay (C) lên trên bộ phận động cơ (A). Khóa màu đỏ (mở)  được căn chỉnh với cái khe trên bộ phận động cơ. (Hình 3 - vị trí 1)
- Xoay bình máy xay (C) một phần tư vòng cho đến khi khóa màu xanh lá (đóng)  xuất hiện. (Hình 3 - vị trí 2)

Có thể có 2 vị trí của bình: tay cầm ở bên phải hoặc trái của bộ phận động cơ.



- Tuân thủ đúng thời gian sử dụng tối đa đối với máy xay sinh tố là 3 phút.
- Máy nghiền thảo mộc (D) cho phép bạn cắt nhỏ một số loại thực phẩm chỉ trong vài giây, ví dụ như hành, tỏi, thịt (cắt thành từng miếng), trái cây sấy khô, cắt lát bánh mì (bánh mì nướng).

Không được sử dụng bộ phận cắt rau củ để cho các chế phẩm lỏng (nước trái cây, v.v.).

- Với bộ phận xay gia vị (E) bạn có thể xay gia vị trong vài giây: hạt rau mùi, tiêu, v.v.
- Các phụ kiện này được trang bị tô (F) giúp tránh chạm vào lưỡi dao trong khi sử dụng.

- 1- Xoay tô (F) và rút thành phần.
- 2- Đặt vòng đệm (d1) hoặc (e1) vào phần thụt vào của nó trên bộ phận dao cắt (d2 hoặc e2). (Hình 4). Đặt bộ phận dao cắt vào tô cho khớp với cả hai dấu trên tô và bộ phận dao cắt. Khóa phụ kiện bằng cách xoay bộ phận dao cắt một phần tư vòng ngược chiều kim đồng hồ. (Hình 5)

Thận trọng: có thể xuất hiện rò rỉ nếu phụ kiện không được khóa đúng cách.

- 3- Xoay bộ lắp ráp (D hoặc E) và đặt nó lên bộ phận động cơ. Khóa màu đỏ (mở)  được căn chỉnh với cái khe trên bộ phận động cơ. (Hình 6 - vị trí 1)
- 4- Sau đó xoay bộ lắp ráp (D hoặc E) một phần tư vòng theo chiều kim đồng hồ cho đến khi khóa màu xanh lá (đóng)  xuất hiện. (Hình 6 - vị trí 2).
- 5- Cắm điện cho thiết bị và vặn nút chọn tốc độ (B) đến vị trí mong muốn hoặc áp dụng vài nhịp đập. Giữ tô (F) khi thiết bị hoạt động. Để dừng thiết bị, vặn nút chọn tốc độ (B) trở về vị trí "0".
- 6- Mở khóa phụ kiện bằng cách xoay nó một phần tư vòng ngược chiều kim đồng hồ cho đến khi khóa màu đỏ (mở)  xuất hiện. Tháo bộ lắp ráp (D, E) ra khỏi bộ phận động cơ.

Lật nó lên một bề mặt trước khi mở khóa bộ phận dao cắt (d2, e2) ra khỏi tô (F) theo thứ tự ngược với thứ tự lắp ráp. Các lưỡi dao rất sắc: xử lý chúng một cách thận trọng để tránh bị thương.

Sau đó bạn có thể lấy chế phẩm trong tô ra.

* Màu sắc của tô có thể thay đổi sau khi xay những thành phần rất cứng nhất định: (đinh hương, quế, V.V.).

Thành phần	Số lượng (tối đa)	Thời gian vận hành	Phụ kiện
Quả mơ / và	60 g	3 giây / tốc độ 2	D
Mẫu vụn	1 bánh bit cốt	10 s cho mỗi nhịp bấm máy chạy	D
Hành	60 g	6 giây / tốc độ 1	D
Hạnh nhân còn vỏ / hạt phỉ	60 g	30 s cho mỗi nhịp bấm máy chạy	D
Ngò tây / rau mùi tươi	10 g	ở chế độ dập	D
Hạt rau mùi	40 g	30 giây /tốc độ 2	E

VỆ SINH THIẾT BỊ CỦA BẠN

- Rút phích cắm của thiết bị và tháo phụ kiện
- Cắm chúng một cách thận trọng: các lưỡi dao trên bình máy xay và các phụ kiện rất sắc.
- Tháo bình và xả bình và nắp bình bằng nước vòi.
- Để vệ sinh bộ phận động CO' (A), sử dụng vải ẩm. Để thật khô.
- Không được để cho bộ phận động CO' (A) tiếp xúc với nước vòi.
- Để dễ vệ sinh, hãy nhớ rửa các bộ phận tháo rời được trong nước và nước rửa chén ngay sau khi sử dụng.
- Để vệ sinh bình máy xay (C) một cách dễ dàng, hãy mở khóa bộ phận dao cắt (c1) bằng cách xoay nó một phần tư vòng ngược chiều kim đồng hồ. Tháo vòng đệm (c2) và vệ sinh bằng nước vòi hoặc trong máy rửa chén.
- **DÒNG MÁY VỚI CỐI THỦY TINH** (theo model) :
Có thể rửa cối thủy tinh (C) trong máy rửa chén ở rổ trên bằng chương trình «ECO» hoặc «PEU SALE». Không được rửa các phụ kiện (D, E) bằng máy rửa chén.
- **DÒNG MÁY VỚI CỐI NHỰA** (theo model) :
Không được rửa cối nhựa (C) và các phụ kiện (D, E) bằng máy rửa chén.

BẠN PHẢI LÀM GÌ NẾU THIẾT BỊ CỦA BẠN KHÔNG HOẠT ĐỘNG?

Vấn đề	Nguyên nhân	Giải pháp
Sản phẩm không hoạt động.	Phích cắm chưa được cắm chính xác vào ổ cắm.	Hãy cắm thiết bị vào một ổ cắm và bật nguồn.
	Bình hoặc phụ kiện không được lắp hoặc khóa chính xác lên bộ phận động cơ.	Kiểm tra xem bình hoặc phụ kiện có được lắp và khóa chính xác lên bộ phận động cơ như minh họa trong hình tài liệu hướng dẫn hay không.
Rung quá mức.	Sản phẩm không được lắp đặt trên một bề mặt phẳng, ổn định, chịu nhiệt.	Hãy đặt sản phẩm lên một bề mặt bằng phẳng.
	Thể tích của các thành phần quá lớn.	Giảm số lượng thành phần được xử lý.
Rò rỉ từ nắp.	Thể tích của các thành phần quá lớn.	Giảm số lượng thành phần được xử lý.
	Nắp không được lắp chính xác.	Khóa nắp chính xác lên bình máy xay.
Rò rỉ từ bộ đỡ bình máy xay.	Vòng đệm bình máy xay (c2) không được đặt chính xác hoặc thiếu.	Đặt lại vòng đệm và khóa bộ đỡ dao cắt một cách chính xác.
Rò rỉ từ bộ đỡ của các phụ kiện.	Vòng đệm trên bộ phận dao cắt (d2) hoặc (e2) không được đặt chính xác hoặc thiếu.	Đặt lại vòng đệm trên bộ phận dao cắt (d2) hoặc (e2) và khóa nỏ vào tô (F) một cách chính xác.
Lưỡi dao không xoay dễ dàng.	Các miếng thức ăn quá lớn hoặc quá cứng.	Giảm kích thước hoặc số lượng thành phần được xử lý. Thêm chất lỏng
Không thể khóa bộ phận dao cắt có vòng đệm (c1+c2) vào bình (c3).	Vòng đệm (c2) không được đặt chính xác.	Lắp lại vòng đệm, 3 nếp gấp phải nhìn thấy như trong Hình 1.

Máy xay của bạn vẫn không hoạt động?

Hãy liên hệ một trung tâm bảo trì được chấp thuận (xem danh sách trong tài liệu về bảo trì). Bạn có thể tùy chỉnh máy xay và mua các phụ kiện sau đây từ đại lý bán

hàng bình thường hoặc từ một trung tâm bảo trì được chấp thuận: Phụ kiện dao cắt rau củ (D), Phụ kiện máy xay gia vị (E), hoặc một bình máy xay bổ sung (C).

PENERANGAN

- A** Unit motor
- B** Pemilih kelajuan
- C** Unit pengisar:
 - **c1** Unit bilah
 - **c2** Gasket
 - **c3** Jug pengisar bersengat
 - **c4** Tudung
 - **c5** Cawan penyukat
- D** Pencancang herba (*aksesori bergantung pada model)
 - **d1** Gasket
 - **d2** Unit bilah pengisar
- E** Pengisar rempah (*aksesori bergantung pada model)
 - **e1** Gasket
 - **e2** Unit bilah rempah
- F** Pencancang herba dan Mangkuk pengisar rempah

Aksesori yang terdapat dalam model akan ditunjukkan pada bahagian atas bungkusan.

AMARAN: Arahan-arahan keselamatan adalah sebahagian daripada perkakas. Sila baca dengan teliti sebelum menggunakan perkakas baru anda. Simpan di tempat yang mudah ditemui dan senang dirujuk pada masa depan.

SISTEM KESELAMATAN



Perkakas hanya boleh beroperasi semasa jug (**C**) atau aksesori (**D** atau **E**) diletakkan

dalam kedudukan yang betul dan dikunci pada unit motor (**A**).

MENGGUNAKAN UNTUK KALI PERTAMA

- Sebelum menggunakan perkakas anda untuk kali pertama, cuci semua aksesori (**C, D, E, F**) dalam air sabun suam, kecuali untuk unit motor (**A**).
- Pastikan semua bungkusan telah dikeluarkan sebelum mengoperasikan perkakas.
- **LANGKAH BERJAGA-JAGA:** Bilah sangat tajam; gunakannya dengan berhati-hati semasa menggunakan atau mencuci perkakas.
- Nota penting: Putar pemilih kelajuan (**B**) kepada "0" sebelum meletakkan jug pengisar atau aksesori pada unit motor.
- Perkakas bermula hanya jika jug atau aksesori diletakkan dengan betul dan dikunci pada badannya.
- **Jangan mengoperasikan pengisar jika tudung tidak berada pada tempatnya**



MENGGUNAKAN PERKAKAS ANDA

- Basahkan gasket (**c2**) dan letakkannya dengan betul pada unit bilah (**c1**): 3 lipatan gasket mesti boleh dilihat sebaik sahaja ia berada pada tempatnya. Jika ia diletakkan dalam arah yang lain, anda tidak boleh menguncinya pada unit bilah pada jag. (Rjh. 1).
 - Letakkan pemasangan (**c1+c2**) pada tapak jug (**c3**). Kuncinya dengan memutar unit bilah melalui putaran sukuan dalam arah melawan jam. (Rjh. 2).
 - Masukkan bahan ke dalam jug yang dipasang tanpa melebihi paras maksimum yang ditunjukkan:
 - * **1.25L untuk campuran tebal**
 - * **1L untuk persediaan cecair.**
 - Letakkan penutup (**c4**) pada jug. Letakkan cawan penyukat (**c5**) dalam relungnya pada penutup.
 - Letakkan pemasangan jug pengisar (**C**) pada unit motor (**A**). Kunci merah (buka ) diselarikan dalam slot pada unit motor. (Rjh. 3 - kedudukan 1)
 - Kemudian, putar jug pengisar (**C**) melalui putaran sukuan sehingga kunci hijau (ditutup)  muncul. (Rjh. 3 - kedudukan 2)
- 2 kemungkinan kedudukan jag: pemegang pada sebelah kanan atau kiri unit motor.
- Masa penggunaan maksimum perkakas selama 3 minit mesti dipatuhi.
 - Dengan pencincang herba (D) anda boleh mencincang bahan seperti bawang merah, bawang putih, daging (dipotong dalam bentuk kepingan) dan buah kering dalam beberapa saat, serta membuat serbuk roti (daripada roti panggang).
- Jangan gunakan pencincang herba untuk persediaan cecair (jus buah-buahan, dll.)
- Dengan pengisar rempah (**E**) anda boleh mengisar rempah dalam beberapa saat: biji ketumbar, lada hitam, dll.
 - Aksesori ini dilengkapi dengan mangkuk (**F**) yang mengelakkan capaian kepada bilah

semasa digunakan.

- 1- Putar mangkuk (**F**) dan tuangkan bahan.
- 2- Letakkan gasket (**d1**) atau (**e1**) dalam relungnya pada unit bilah (**d2** atau **e2**). (Rjh. 4).
4. Letakkan kedudukan unit bilah pada mangkuk selari dengan tanda pada mangkuk dan unit bilah. Kunci aksesori dengan memutar unit bilah melalui putaran sukuan dalam arah melawan jam. (Rjh. 5).

Langkah berjaga-jaga: kebocoran boleh berlaku jika aksesori tidak dikunci dengan betul.

- 3- Putar pemasangan yang pasang (**D** atau **E**) dan kedudukannya pada unit motor. Kunci merah (buka)  diselarikan dalam slot pada unit motor. (Rjh. 6 - kedudukan 1)
 - 4- Kemudian, putar aksesori yang dipasang (**D** atau **E**) melalui putaran sukuan sehingga kunci hijau (ditutup)  muncul. (Rjh. 6 - kedudukan 2)
 - 5- Pasang plug perkakas dan putar pemilih kelajuan (**B**) ke kedudukan yang dikehendaki atau gunakan beberapa denyutan. Pegang mangkuk (**F**) semasa perkakas sedang digunakan. Untuk menghentikan perkakas, putar pemilih kelajuan (**B**) kembali ke kedudukan "0".
 - 6- Buka kunci aksesori dengan memutarnya melalui putaran sukuan dalam arah melawan jam, sehingga kunci merah (buka)  muncul. Tanggalkan aksesori yang dipasang (**D, E**) dari unit motor.
- Putar pada tempat kerja sebelum membuka kunci unit bilah (**d2, e2**) dari mangkuk (**F**) dalam susunan terbalik bagi pemasangan. Bilah sangat tajam: gunakannya dengan berhati-hati untuk mengelakkan kecederaan.

Kemudian, anda boleh mengambil penyediaan dalam mangkuk.
* Warna mangkuk mungkin berubah selepas mengisar beberapa bahan yang sangat keras: (bunga cengkih, kulit kayu manis, dll.).

Bahan	Kuantiti (maks.)	Masa operasi	Aksesori
Aprikot / buah dalam tin	60 g	3 s / kelajuan 2	D
Serbuk	1 bánh bit cốt	10 saat setiap putaran	D
Bawang	60 g	6 saat / kelajuan 1	D
Buah badam berkulit / kacang hazel	60 g	30 saat setiap putaran	D
Pasli / ketumbar segar	10 g	Dalam denyutan	D
Biji ketumbar	40 g	30 saat / kelajuan 2	E

MENCUCI PERKAKAS ANDA

- Cabut plug perkakas dan tanggalkan aksesori
- Gunakannya dengan berhati-hati: bilah pada jug pengisar dan aksesori adalah tajam.
- Tanggalkan jug dan bilaskannya bersama penutup di bawah air yang mengalir.
- Untuk mencuci unit motor (**A**), gunakan kain yang lembap. Keringkannya dengan berhati-hati.
- Jangan tenggelamkan unit motor (**A**) dalam air yang mengalir.
- Untuk pencucian mudah, pastikan anda membasuh bahagian yang boleh ditanggalkan dalam air dan sedikit cecair pencucian serta-merta selepas menggunakannya.
- Untuk mencuci jug pengisar (**C**) dengan mudah, buka kunci unit bilah (**c1**) dengan memutarnya melalui putaran sukuan dalam arah melawan arah jam. Tanggalkan gasket (**c2**) dan cucikannya di bawah air yang mengalir atau dalam pencuci pinggan-mangkuk.
- **JENIS MANGKUK KACA** (berdasarkan model):
Mangkuk kaca (**C**) boleh dicuci dengan menggunakan mesin pencuci pinggan pada rak paling tinggi dengan program «EKO» atau «KURANG KOTOR». Aksesori-aksesori (**D, E**) tidak boleh dicuci dengan menggunakan mesin pencuci pinggan.
- **JENIS MANGKUK PLASTIK** (berdasarkan model):
Mangkuk plastik (**C**) dan aksesori-aksesori (**D, E**) tidak boleh dicuci dengan menggunakan mesin pencuci pinggan.

APA YANG PERLU DILAKUKAN JIKA PERKAKAS ANDA TIDAK BERFUNGSI ?

Masalah	Punca	Penyelesaian
Produk tidak berfungsi.	Plug tidak dimuatkan dengan betul ke dalam soket.	asang plug perkakas ke dalam soket dan hidupkannya.
	Jug atau aksesori tidak diletakkan dengan betul atau dikunci pada unit motor.	Periksa bahawa jug atau aksesori diletakkan dengan betul dan dikunci pada unit motor seperti yang ditunjukkan dalam rajah dalam manual.
Getaran berlebihan.	Produk tidak diletakkan pada permukaan yang rata, stabil, tahan haba.	Letakkan produk pada permukaan yang rata.
	Isipadu bahan adalah terlalu tinggi.	Kurangkan kuantiti bahan yang diproses.
Kebocoran dari penutup.	Isipadu bahan adalah terlalu tinggi.	Kurangkan kuantiti bahan yang diproses.
	Penutup tidak diletakkan dengan betul.	Kunci penutup dengan betul pada jug pengisar.
Kebocoran dari tapak jug pengisar	Gasket jug pengisar (c2) tidak diletakkan dengan betul atau tiada.	Letakkan semula gasket dan kunci pemegang bilah dengan betul.
Kebocoran dari tapak aksesori.	Gasket pada unit bilah (d2) atau (e2) tidak diletakkan dengan betul atau tiada.	Letakkan semula gasket pada unit bilah (d2) atau (e2) dan kuncinya dengan betul ke atas mangkuk (F).
Bilah tidak berputar dengan mudah.	Kepingan makanan terlalu besar atau terlalu keras.	Kurangkan saiz atau kuantiti bahan yang diproses. Tambah air
Tidak dapat mengunci unit bilah dengan gasket (c1+c2) pada jag (c3).	Gasket (c2) tidak diletakkan dengan betul.	Letakkan semula gasket, 3 lipatan boleh dilihat seperti yang ditunjukkan dalam Rjh. 1.

Pengisar anda masih tidak berfungsi?

Hubungi pusat perkhidmatan yang diluluskan (lihat senarai dalam buku kecil perkhidmatan).

Anda boleh menyesuaikan pengisar anda dan mendapatkan aksesori lain dari pengedar biasa anda atau dari pusat

perkhidmatan yang diluluskan. Aksesori pencancang herba (**D**), Aksesori pengisar rempah (**E**), atau jag pengisar tambahan (**C**).

รายละเอียดของเครื่องปั่น

- A** ฐานมอเตอร์
B สวิตช์ควบคุมการทำงาน 0 / 1 / 2 / Pulse
C ชุดโถปั่น:
 - **c1** ชุดใบมีด
 - **c2** ซิลยางกันรั่วซึม
 - **c3** โถปั่นแบบมีขีดแสดงระดับ
 - **c4** ฝาปิด
 - **c5** ถ้วยตวง

- D** โถบดสับ
 (*อุปกรณ์เสริมจะแตกต่างกันไปในแต่ละรุ่น)
 - **d1** ซิลยางกันรั่วซึม
 - **d2** ชุดใบมีดของโถบดสับ
E โถบดแห้ง
 (*อุปกรณ์เสริมจะแตกต่างกันไปในแต่ละรุ่น)
 - **e1** ซิลยางกันรั่วซึม
 - **e2** ชุดใบมีดบดแห้ง
F ฝาครอบสำหรับโถบดสับและโถบดแห้ง

รายการอุปกรณ์เสริมต่าง ๆ ที่มีอยู่ในแต่ละรุ่นที่คุณซื้อจะแสดงอยู่บนป้ายที่ติดอยู่ตรงด้านบน ของบรรจุภัณฑ์

คำเตือน : คำแนะนำเพื่อความปลอดภัยมาพร้อมกับเครื่อง
 ครัววอานละเอียดก่อนใช้กล่องถายรูป
 เก็บไว้ในที่ที่ห่างายสำหรับดูในคราวต่อไป

ระบบล๊อคนิรภัย

เครื่องปั่นจะสามารถทำงานได้ เมื่อ
 ประกอบและล๊อคโถปั่น (C) หรืออุปกรณ์เสริม

(D หรือ E) เข้าที่อย่างถูกต้องบนแท่น
 มอเตอร์ (A) แล้วเท่านั้น

ก่อนการใช้งานครั้งแรก

- ก่อนที่จะใช้งานเครื่องปั่นเป็นครั้งแรก
 คุณควรทำความสะอาดอุปกรณ์เสริมทุกชิ้น
 (C, D, E, F) ด้วยน้ำสบู่อุ่น ๆ ยกเว้น
 แท่นมอเตอร์ (A)
คำเตือน: ใบมีดมีความคมมาก
 ให้ใช้งานด้วยความระมัดระวังเมื่อใช้งาน
 หรือทำความสะอาดเครื่องปั่น
- ตรวจสอบให้แน่ใจว่าได้แกะบรรจุภัณฑ์ทุกชิ้น
 ออกแล้ว ก่อนที่จะเปิดทำงานเครื่องปั่น

- สิ่งสำคัญที่ต้องจำ: หมนปุมปรับระดับ
 ความเร็ว (B) ไปที่ "0" ก่อนที่จะประกอบ
 โถปั่น หรืออุปกรณ์เสริมบนแท่นมอเตอร์
- เครื่องปั่นจะเริ่มทำงานก็ต่อเมื่อคุณประกอบ
 และล๊อคโถปั่นหรืออุปกรณ์เสริมเข้าที่อย่าง
 ถูกต้องแล้ว เท่านั้น
- ห้ามเปิดทำงานเครื่องปั่นหากยังปิด
 ฝาไม่เข้าที่

การใช้งานเครื่องปั่น

- เช็ดซิลยางกันรั่วซึม (c2) ให้เปียกน้ำพอ
 หมด ๆ แล้วใส่ให้เข้าที่บนชุดใบมีด (c1):
 คุณจะต้องมองเห็นรอยพับ 3 ร่องของซิล

ยางกันรั่วซึมได้อย่างชัดเจนเมื่อใส่ซิลยาง
 เข้าที่ดีแล้ว ถ้าคุณใส่ซิลยางกันรั่วซึมใน
 ทิศทางอื่น คุณจะไม่สามารถล๊อคชุดใบมีดบน
 โถปั่นได้ (รูปที่ 1)

- ใส่ชุดประกอบโกป็น (c1+c2) เข้ากับฐานด้านล่างของโกป็น (c3) ล็อคชุดประกอบเข้ากับ โกป็นโดยหมุนทวนเข็มนาฬิกา 90 องศา (รูปที่ 2)

- เทส่วนผสมลงในโกที่ประกอบแล้วโดยไม่ให้เกินระดับสูงสุดที่กำหนด:

* 1.25 ลิตรสำหรับส่วนผสมที่เหนียวขึ้น

* 1 ลิตร สำหรับการเตรียมของเหลว

- ล็อคฝาปิด (c4) บนโกป็น วางถ้วยตวง (c5) ในช่องบนฝาปิด

- วางชุดประกอบโกป็น (C) บนแท่นมอเตอร์ (A) ตัวล็อคสีแดง (กุญแจเปิด) (๒) จะอยู่ตรงกันในห้องแสดงบนแท่นมอเตอร์ (รูปที่ 3 - ตำแหน่งที่ 1)

- จากนั้น ให้หมุนโกป็น (C) 90 องศาจนกว่าตัวล็อคสีเขียว (กุญแจเปิด) (๒) ปรากฏขึ้นมา (รูปที่ 3 - ตำแหน่งที่ 2)

คุณสามารถวางโกป็นบนแท่นมอเตอร์ได้ 2 ตำแหน่ง: โดยวางทางด้านซ้ายหรือด้านขวาของแท่นมอเตอร์

- ระยะเวลาในการปั่น

โดยเครื่องปั่นสามารถปั่นได้นานสูงสุด 3 นาที

- คุณสามารถใช้โอบดลับ (D) เพื่อสับส่วนผสมต่าง ๆ เช่น หัวหอม, กระเทียม (หั่นเป็นชิ้น ๆ), ผลไม้แห้ง และทำขนมปังชิ้นเล็ก ๆ (ขนมปังกรอบ) ได้ในเวลาเพียงแค่ไม่กี่วินาที

- คุณสามารถใช้โอบดแห้ง (E) เพื่ออบค้เครื่องเทศได้ภายในเวลาเพียงแค่ไม่กี่วินาที: เช่น เมล็ดผักชี พริกไทย เป็นต้น

- ชุดอุปกรณ์เสริมเหล่านี้จะมีฝาครอบ (F) เพื่อช่วยป้องกันไม่ให้ใบมีดบาดผู้ใช้ ในระหว่างการใช้งาน

1- หมุนฝาครอบออก (F) แล้วเทส่วนผสมลงไป

2- วางซีลยางกันรั่วซึม (d1) หรือ (e1)

ลงในร่องบนชุดใบมีด (d2 หรือ e2) (รูปที่ 4) ประกอบชุดใบมีดบนฝาครอบโดยหมุนให้เครื่องหมาย บนฝาครอบตรงกับเครื่องหมายบนชุดใบมีด ล็อคอุปกรณ์เสริมโดยหมุนชุดใบมีดทวนเข็มนาฬิกา 90 องศา (รูปที่ 5)

คำเตือน: ส่วนผสมอาจรั่วซึมได้หากคุณไม่ได้ล็อคอุปกรณ์เสริมให้เข้าที่อย่างถูกต้อง

- 3-** หมุนชุดที่ประกอบแล้ว (D หรือ E) ให้เข้าที่บนแท่นมอเตอร์ ตัวล็อคสีแดง (กุญแจเปิด) (๒) จะอยู่ตรงกันในสลอตบนแท่นมอเตอร์ (รูปที่ 6 - ตำแหน่งที่ 1)

- 4-** จากนั้น หมุนชุดที่ประกอบแล้ว (D หรือ E) 90 องศาจนกว่าตัวล็อคสีเขียว (กุญแจเปิด) (๒) จะปรากฏขึ้นมา (รูปที่ 6 - ตำแหน่งที่ 2)

- 5-** เสียบปลั๊กเครื่องปั่น แล้วหมุนปุ่มปรับระดับความเร็ว (B) ไปยังตำแหน่งที่ต้องการหรือใช้ฟังก์ชัน Pulse สัก 2-3 วินาที จับฝาครอบ (F) ไว้ให้แน่นขณะที่เครื่องปั่นกำลังทำงาน หากต้องการหยุดเครื่องปั่น ให้หมุนปุ่มปรับระดับความเร็ว (B) กลับไปที่ตำแหน่ง "0"

- 6-** ปลดล็อคอุปกรณ์เสริมโดยหมุนทวนเข็มนาฬิกา 90 องศาจนกว่าตัวล็อคสีแดง (กุญแจเปิด) (๒) จะปรากฏขึ้นมา ถอดชุดอุปกรณ์ที่ประกอบแล้ว (D, E) ออกจากแท่นมอเตอร์ วางหงายขึ้นบนพื้นเรียบก่อนที่จะปลดล็อคชุดใบมีด (d2, e2) ออกจากฝาครอบ (F) ในทิศทางตรงกันข้ามกับตอนประกอบ คุณสามารถเก็บส่วนผสมที่เตรียมไว้ในฝาครอบนั้นได้

* ฝาครอบอาจเปลี่ยนสีได้หากใช้กับส่วนผสมที่เป็นเนื้อแข็งบางอย่าง (เช่น กานพลูหรืออบเชย เป็นต้น)

ส่วนผสม	ปริมาณ (สูงสุด)	ระยะเวลาทำงาน	อุปกรณ์เสริม
แอมปริคอต / มะเดื่อ	60 กรัม	4 วินาที / ความเร็ว 2	D
เศษขนมปัง	1 ก้อน	10 วิ ต่อการปั่นชั่วขณะ	D
หัวหอม	60 กรัม	6 วินาที / ความเร็ว 1	D
อัลมอนต์ / ฮาเซลนัท ปอกเปลือก	60 กรัม	30 วิ ต่อการปั่นชั่วขณะ	D
ผักชีฝรั่ง / ผักชีสด	10 กรัม	ฟังก์ชัน Pulse	D
เมล็ดผักชี	40 กรัม	30 วินาที / ความเร็ว 2	E

การทำความสะอาดเครื่องปั่น

- ถอดปลั๊กเครื่องปั่นและถอดอุปกรณ์เสริมออก
- ใช้งานด้วยความระมัดระวัง: ใม่มีดบนโถปั่นของเครื่องปั่นและอุปกรณ์เสริมมีความคมมาก
- ถอดโถปั่นออก แล้วล้างโถปั่นและฝาปิดโดยเปิดน้ำก๊อกไหลผ่าน
- วิธีการทำความสะอาดแท่นมอเตอร์ (A) ให้ใช้ผ้าชุบน้ำบิดพอหมาดเช็ด เช็ดให้แห้งด้วยความระมัดระวัง
- ห้ามจุ่มแท่นมอเตอร์ (A) ใต้น้ำก๊อกที่กำลังไหล
- การทำความสะอาดที่ง่ายที่สุดคือให้ทำความสะอาดชิ้นส่วนที่ถอดออกได้ด้วยน้ำสบู่อุ่น ๆ ทันทีหลังการใช้งาน
- วิธีการทำความสะอาดโถปั่นของเครื่องปั่น (C) ให้สะอาดได้ง่าย ๆ ให้ปลดลิ้นชุดใบมีด (c1) ด้วยการหมุนทวนเข็มนาฬิกา 90 องศา ถอดซีลยางกันรั้วซีม (c2) ออกแล้วทำความสะอาด โดยเปิดน้ำก๊อกให้ไหลผ่าน หรือใส่ในเครื่องล้างจาน
- สำหรับโถปั่นแก้ว (ขึ้นอยู่กับรุ่น) : โถแก้ว (C) สามารถนำไปล้างในเครื่องล้างจานโดยใส่ในตะกร้าชั้นบนสุดพร้อมเลือกโปรแกรม "ประหยัด" หรือ "สปรกน้อย" อุปกรณ์เสริม (D, E) จะต้องไม่นำไปล้างในเครื่องล้างจาน
- สำหรับโถปั่นพลาสติก (ขึ้นอยู่กับรุ่น) : โถพลาสติก (C) และอุปกรณ์เสริม (D, E) จะต้องไม่นำไปล้างในเครื่องล้างจาน

วิธีการแก้ปัญหาเมื่อเครื่องปั่นไม่ทำงาน

ปัญหา	สาเหตุ	วิธีแก้ไข
สินค้าไม่ทำงาน	เสียบปลั๊กไม่ถูกต้อง	เสียบปลั๊กเครื่องปั่นเข้ากับเต้ารับที่มีแรงดันไฟฟ้าเท่ากัน
	ประกอบหรือลอคโกปปั่นหรืออุปกรณ์เสริม ไม่เข้าที่บนแท่นมอเตอร์	ตรวจสอบว่าได้ประกอบหรือลอคโกปปั่นหรืออุปกรณ์เสริมให้เข้าที่บนแท่นมอเตอร์ ตามรูปประกอบที่แสดงอยู่ในคู่มือ
เครื่องสั่นสะเทือนมากเกินไป	ไม่ได้วางสินค้าบนพื้นผิวที่เรียบ	ให้วางสินค้าบนพื้นผิวที่เรียบ
	ใส่ส่วนผสมในปริมาณมากเกินไป	ลดปริมาณส่วนผสมที่จะปั่นหรือบดให้น้อยลง
มีส่วนผสมรั่วซึมออกมาจากฝาปิด	ใส่ส่วนผสมในปริมาณมากเกินไป	ลดปริมาณส่วนผสมที่จะปั่นหรือบดให้น้อยลง
	ปิดฝาปิดไม่เข้าที่	ลอคฝาปิดให้ถูกต้องบนโกปปั่น
มีส่วนผสมรั่วซึมออกมาจากฐานของโกปปั่น	ใส่ซิลยางกันรั่วซึม (c2) ของโกปปั่นไม่ถูกต้องหรือไม่ได้ใส่ซิลยางกันรั่วซึม	ใส่ซิลยางกันรั่วซึมใหม่ให้เข้าที่ แล้วลอคตัวยึดใบมีดให้ถูกต้อง
มีส่วนผสมรั่วซึมออกมาจากฐานของอุปกรณ์เสริม	ลอคซิลยางกันรั่วซึมบนชุดใบมีด (d2) หรือ (e2) ไม่ถูกต้องหรือไม่ได้ใส่ซิลยางกันรั่วซึม	ใส่ซิลยางกันรั่วซึมบนชุดใบมีด (d2) หรือ (e2) ใหม่ให้เข้าที่ และลอคบนฝาปิดให้ถูกต้อง (F)
ใบมีดติดขัด	ใส่อาหารชิ้นใหญ่เกินไปหรือแข็งเกินไป	ลดขนาดหรือปริมาณของส่วนผสมที่จะปั่นหรือบดให้น้อยลง เติมของเหลวให้มากขึ้น
ไม่สามารถลอคชุดใบมีดเข้ากับซิลยางกันรั่วซึม (c1+c2) บนโกปปั่น (c3)	ใส่ซิลยางกันรั่วซึม (c2) ไม่เข้าที่	ใส่ซิลยางกันรั่วซึมใหม่ให้เข้าที่ คุณจะต้องมองเห็นรอยบัพ 3 ร่องได้อย่างชัดเจน ดังที่แสดงในรูปที่ 1

เครื่องปั่นของคุณยังไม่ทำงานตามปกติอีกหรือ?

โปรดติดต่อศูนย์บริการที่ได้รับอนุญาต (โปรดดูรายชื่อศูนย์บริการได้จากคู่มือการบริการ) คุณสามารถปรับเปลี่ยนเครื่องปั่นของคุณและรับอุปกรณ์เสริมต่อไปนี้ได้จากดีลเลอร์

เจ้าประจำของคุณ หรือจากศูนย์บริการที่ได้รับอนุญาต: อุปกรณ์เสริมโกปคลับ (D) อุปกรณ์เสริมโกปคดแห่ง (E) หรือโกปปั่นเพิ่มอีกหนึ่งชิ้น (C)

각부명칭

- | | |
|--|---|
| <p>A 모터본체</p> <p>B 속도조절 다이얼</p> <p>C 믹서용기</p> <ul style="list-style-type: none"> - C1 칼날몸체 - C2 누수방지 실리콘링 - C3 믹서용기 - C4 믹서용기 뚜껑 - C5 계량컵 | <p>D 다지기악세서리
(모델에 따라 다름)</p> <ul style="list-style-type: none"> - d1 누수방지 실리콘링 - d2 다지기용칼날몸체 <p>E 분쇄기악세서리
(모델에 따라 다름)</p> <ul style="list-style-type: none"> - e1 누수방지 실리콘링 - e2 분쇄기용칼날몸체 <p>F 다지기과 분쇄기를위한용기</p> |
|--|---|

구매하신 제품의 모델에 해당되는 악세서리는 제품 패키지 겉면에서 확인하실 수 있습니다.

주의사항: 안전 지침은 기기 구성의 일부를 이룹니다. 새 기기 사용 전 주의해서 잘 읽어 두시기 바랍니다. 이후 참고를 위해 찾기 쉬운 장소에 보관해 두십시오.

안전 잠금 장치

믹서 용기(C) 또는 다지기 및 분쇄기 악세서리 (D 또는 E)가 모터 본체에 정확하게 장착 되어야만 제품이 작동됩니다. 만일

용기가 모터본체에 정확하게 장착되지 않으면 안전잠금장치에 의해 제품은 작동되지 않습니다.

제품을 처음 사용하기 전

- 본 제품을 사용하기 전에 모터본체 (A)를 제외한 모든 부속품 (C, D, E, F)을 따뜻한물로 세척하여 주십시오.
- **주의: 칼날이 날카로우므로 사고의 방지를 위해 제품을 사용하거나 세척 시에 손으로 직접 만지지 말고 주의를 기울이십시오.**
- 모든 포장물은 제품을 사용하기 전에 제거 하십시오.
- **주의:** 용기를 모터 본체에 끼우시기 전에 속도조절다이얼(B)을 0에 맞추십시오.
- 제품은 용기 혹은 악세서리가 모터 본체에 올바르게 장착 되어 잠금상태가 되어야만 작동합니다.
- 만약용기의 뚜껑이 제대로 닫혀져 있지 않으면 제품을 작동하지 마십시오.

제품 사용하기

- 칼날몸체(c1)에 누수방지 실리코링(C2)을 정확하게 장착시키십시오. 제대로 장착시켰을 경우 누수방지 실리코링의 3줄 선이 보이어 합니다. 만약 반대로 장착했을 경우는 용기에 칼날 몸체가 잠기지 않습니다. (Fig.1).
- 누수방지 실리코링을 끼운 칼날 본체 (c1 +c2)를 용기 (c3) 아래쪽에 끼우십시오. 장착하시는 요령은 칼날몸체를 1/4정도시계 반대방향으로 돌리시면 됩니다.(Fig.2).
- 음식물이 최대용량을 넘지 않도록 주의하며, 조립된 용기에 음식 재료를 넣어주십시오.
 - * 고체로 된 재료를 혼합하실 때: 1.25L
 - * 액체로된 재료를 혼합하실 때: 1L
- 믹서용기 위에 뚜껑(c4)을 닫아주십시오. 계량컵(c5)을 뚜껑 위에 끼워 닫아 주십시오.
- 모터 본체(A)에 조립된 용기(C)를 장착하십시오.모터 본체의 홈에 믹서용기의 빨간색의 잠김해제 ㉞ 표시가 보이도록 맞춰 끼우십시오. (Fig 3-1 위치)
- 모터 본체에 용기를 잠그기 위해서 용기를 1/4정도시계방향 으로 돌려 초록색의 잠김 ㉞ 표시가 나타나도록 잠그십시오. (Fig 3-2 위치)
믹서용기는 믹서 본체에 손잡이가 왼쪽으로 오게 장착하거나 오른쪽으로 오게 장착하는 두가지 방법이 있습니다.
- 블렌더 사용시간은 3분이 넘지 않도록 합니다.
- 허브 분쇄기(D)로는 단 몇 초 안에 양파, 마늘, 고기(잘게 썬 것), 마른 과일을 갈거나 빵가루를 만들기에 도 좋습니다(비스킷용). 과일 주스와 같은 액체를 만들기 위해서는 다지기를 사용하지 마시고 믹서기를 사용하십시오.
- 분쇄기 (E)를 이용하여 헤이즐넛, 호두, 아몬드, 쌀, 마른 양념 등 마른재료를 몇초 안에 분쇄할 수 있습니다.
- 다지기와분쇄기를 사용할경우에는 반드시 용기(F)를장착 하여 사용하십시오.

- 1- 용기를 뒤집어 내용물을 용기에 넣으십시오.
- 2- 누수방지 실리코링 (d1 또는 e1)을 칼날 본체 (d2 또는 e2)에 끼우십시오. (Fig. 4). 칼날 본체에 있는 확실표 표시와 용기에 있는 확실표 표시를 서로 맞추어 끼우십시오.칼날 본체를 시계 반대방향으로 1/4 정도 돌려 잠그십시오.(Fig.5)

용기 및 악세서리가 정확하게 장착되지 않은

- 3- 조립된 용기(D 또는 E)를 모터 본체 위에 끼우십시오.모터 본체의 홈에 믹서용기의 빨간색의 잠김해제 ㉞ 표시가 보이도록 맞춰 끼우십시오.(Fig. 6-2위치).
- 4- 조립된 용기를 모터 본체에 잠그기 위해서 용기를 1/4정도 시계방향으로 돌려 초록색의 잠김 ㉞ 표시된 부분이 나타나도록 잠그십시오. (Fig 6-2 위치)
- 5- 전원을 연결한 후, 속도조절 다이얼(B)을 돌려 작동하십시오.재료에 따라 필스기능을 작동하실 수도 있습니다.제품이 작동 중일 때는 용기를 잡아 고정시켜주고 제품의 작동을 멈추시려면 속도조절 다이얼(B)을 "0" 위치로 되돌리십시오.
- 6- 모터 본체에 잠겨진 용기를 분리하기 위해서는 빨간색의 잠금 해제 ㉞ 표시가 나타날 때까지 시계 반대방향으로 돌리십시오.그 후, 모터 본체에서 용기(D 또는 E)를 분리 하십시오.

칼날 본체 (d2 또는 e2)를 용기 (F)에서 잠금을 해제하기 전에 제품을 평평한 바닥 위에 뒤집어 올려 놓고 조립 순서의 반대 방향으로 분해하십시오.칼날이 날카로우므로 사고의 방지를 위해 손으로 직접 만지지 말고 주의기를 기울이십시오.칼날이 용기에서 분리된 후, 용기에 있는 음식 재료를 다른 용기로 옮길 수 있습니다.

* 색을가진 음식 재료를 넣어 작동 하였을경우 용기의 색이 변색될 수 있습니다.

재료	수량 (최대)	동시간	액세서리
마늘	60 g	시간: 3 초 /속도: 2단계	D
빵가루	1 rusk	펄스당 10초	D
양파	60 g	시간: 6 초/속도:1단계	D
껍질을 깐아몬드/헤이즐넛	60 g	펄스당 30초	D
파슬리	10 g	순간작동으로 여러 번	D
마른 견과류	40 g	시간: 30 초/속도: 2단계	E

세척하기

- 제품의 전원코드를 뽑고 모든 액세서리들을 분리해 주십시오.
- 주의: 칼날이 날카롭습니다. 칼날을 분리할 때나 세척할 때는 항상 주의하십시오.
- 용기를 모터본체에서 분리한 후, 용기를 흐르는 물에 행귀주시고, 주변부속품도 같이 행귀주십시오.
- 모터본체(A)는 젖은 수건으로만 닦은 후, 조심스럽게 말려 주십시오.
- 모터본체(A)를 흐르는 물에 절대 담그지 마십시오.
- 제품을 쉽게 세척하려면, 제품 사용 직후 소량의 주방용세제를 사용 물세척 하십시오.
- 믹서용기(C)를 쉽게 세척하려면, 칼날본체(C1)를 용기에서 반시계 방향으로 1/4정도 돌려 분리하고 누수방지 실리콘(C2) 또한 분리한 후, 식기세척기 또는 흐르는 물에 세척하여 주십시오.
- 유리 용기(모델별): 유리 용기(C)는 식기세척기 상부 바구니에서 "절전" 또는 "간단 세척" 모드에서 세척할 수 있습니다. 액세서리들(D, E)은 식기세척기에서 세척이 불가능합니다.
- 플라스틱 용기 버전(모델별): 플라스틱 용기(C) 및 액세서리들(D, E)은 식기세척기에서 세척이 불가능합니다.

제품이 작동하지 않을 때는?

문 제	원 인	해결방법
제품이 작동하지 않습니다.	전원코드가 연결되어 있지 않습니다.	전원코드를 연결하여 주십시오.
	믹서용기 또는 악세서리가 모터 본체에 정확하게 장착되어 있지 않거나 모터 본체가 제대로 잠겨 있지 않습니다.	믹서용기 또는 악세서리가 정확하게 장착되었는지를 확인하시고 잠금 그림이 보이도록 용기를 정확히 돌려 장착하십시오. (제품 사용하기 참조)
제품 작동 시 심한 진동이 있습니다.	제품이 평평한 표면에 놓여있지 않습니다.	제품을 평평한 표면에 놓아 주십시오.
	재료를 너무 많이 넣었습니다.	재료의 양을 줄이십시오.
뚜껑을 통해 액체가 새어나옵니다.	재료를 너무 많이 넣었습니다.	재료의 양을 줄이십시오.
	믹서용기의 뚜껑이 제대로 닫혀 있지 않았습니다.	믹서용기의 뚜껑을 제대로 닫아 주십시오.
용기 밑부분을 통해 액체가 새어나옵니다.	누수방지 실리콘링(C2)이 제대로 장착되어 있지 않거나 장착하지 않았습니다.	누수방지 실리콘링(C2)을 정확히 장착하신 후 용기에 칼날 본체를 정확히 끼워 잠그십시오.
다지기나 분쇄기 밑부분을 통해 내용물이 새어나옵니다.	누수방지 실리콘링(C2)이 다지기(d2) 및 분쇄기(e2) 칼날 본체에 제대로 장착되어 있지 않거나 장착하지 않았습니다.	누수방지 실리콘링(C2)을 다시 칼날 본체(d2) 또는(e2)에 장착시킨 후, 용기(f)에 칼날 본체를 정확하게 끼워 잠그십시오.
칼날이 잘 돌아가지 않습니다.	재료가 너무 크거나 너무 단단합니다.	재료의 크기 또는 양을 줄이십시오. 액체를 첨가하십시오.
믹서용기(C3)에 누수방지 실리콘링(C1+C2)을 장착한 칼날 본체가 잠기지 않습니다.	누수방지 실리콘링(C2)이 정확하게 장착되어 있지 않습니다.	누수방지 실리콘링(C2)의 3줄이 보이도록 다시 칼날 본체에 정착하십시오 (fig.1)

제품이 여전히 작동하지 않습니까?

제품이 계속 작동하지 않을 경우 당사서비스센터에 의뢰하십시오. (대우일렉 서비스 전국어디서나 1588-1588)