

Moulinex®

pro first

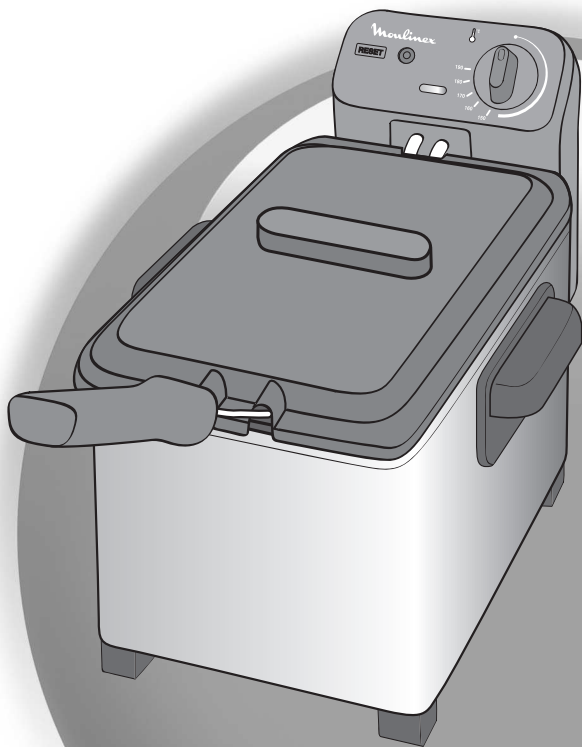

www.moulinex.com

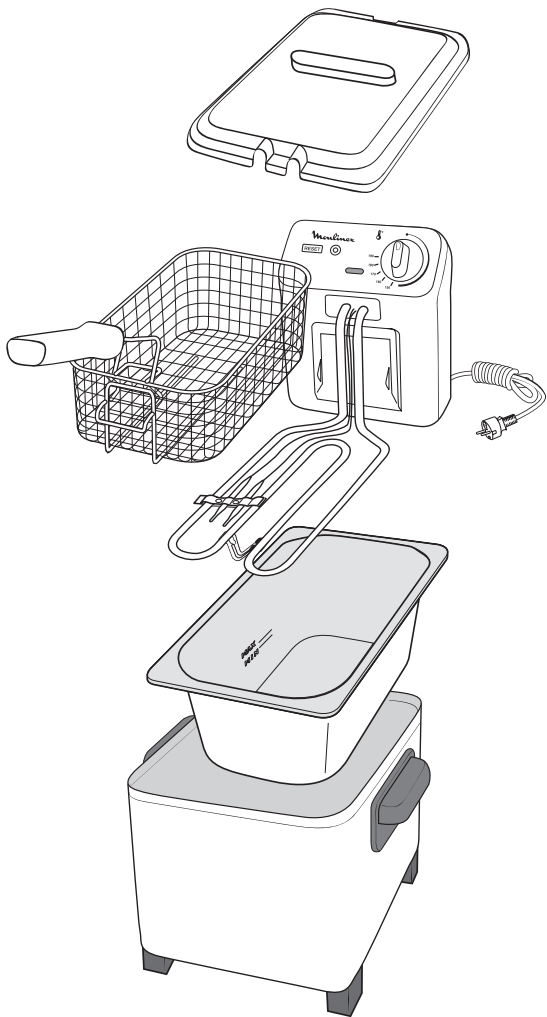

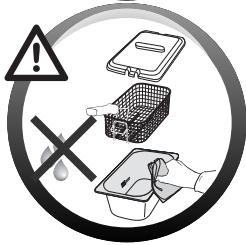
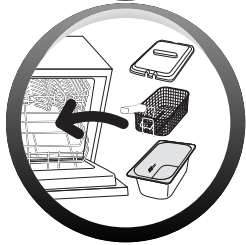
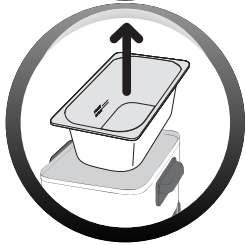
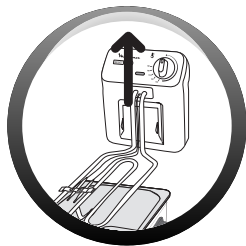
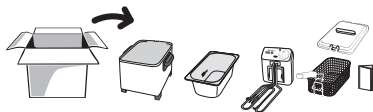
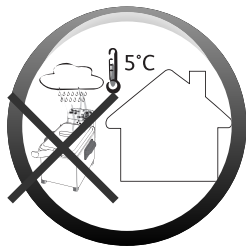

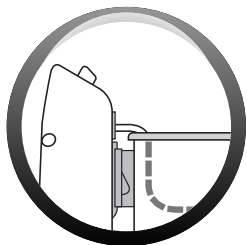
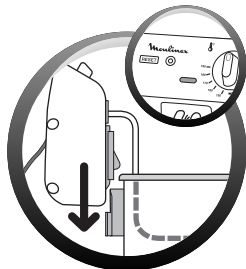
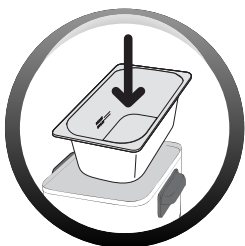
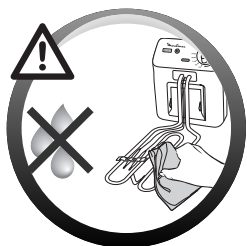
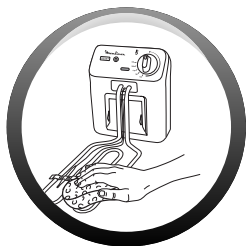



Model 4L
Min. 3,6L
Max. 4L



Model.4L Min.3150g Max.3500g

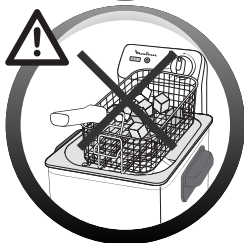

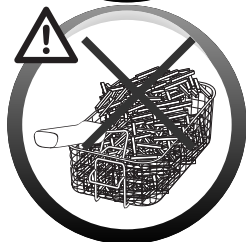
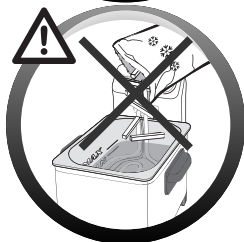
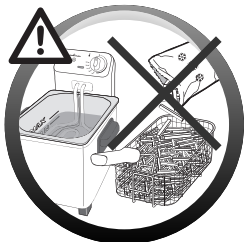
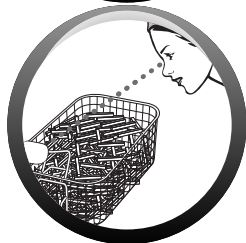
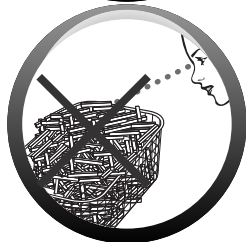
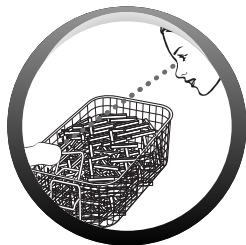
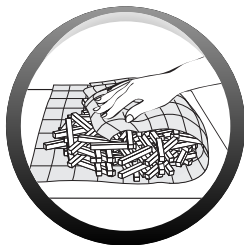

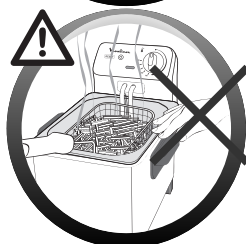
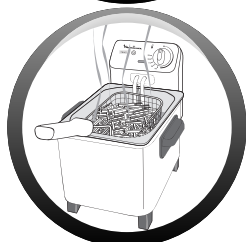
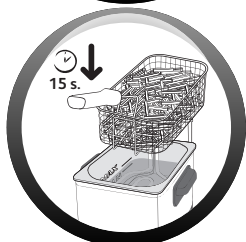
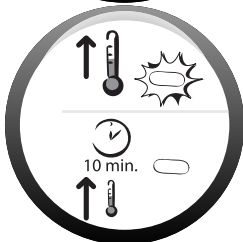
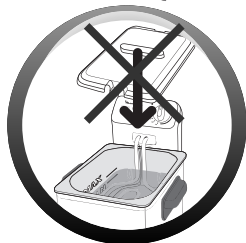
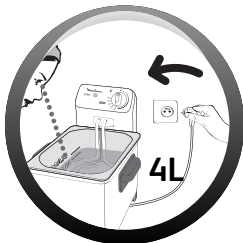



	Nb		°C	
		600 g	170°C	9-12 min.
		1000 g	170°C	12-15 min.
		1200 g	170°C	9-11 min.
			170°C	6-8 min.
	8		180°C	14-16 min.
	1-2		170°C	6-8 min.
	8		150°C	5-7 min.
	6-8		170°C	3-4 min.
	4		180°C	5-6 min.
		500 g	180°C	5-6 min.
	10-12		180°C	6-8 min.
* * *	Nb		°C	
		450 g	170°C	8-12 min.
		900 g	170°C	12-16 min.
		500 g	190°C	8-10 min.
	8		190°C	5-7 min.
		900 g	190°C	6-8 min.
	1-2		190°C	14-15 min.
	12		170°C	4-5 min.
	6-8		190°C	3-4 min.

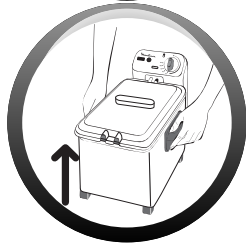
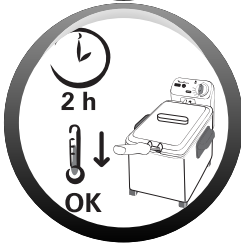
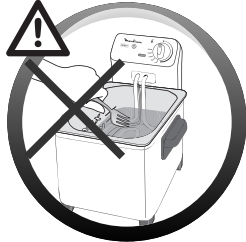
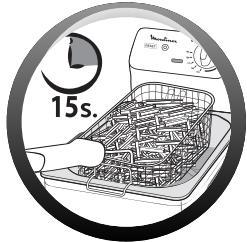
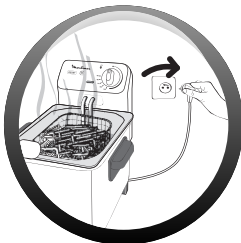
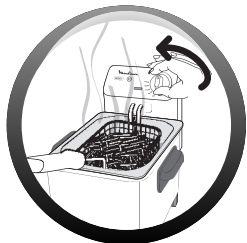

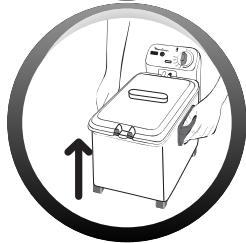
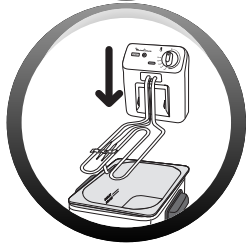
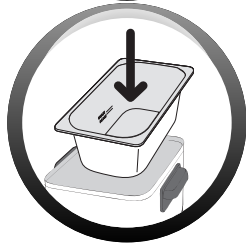
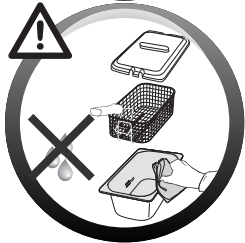
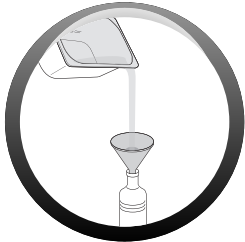
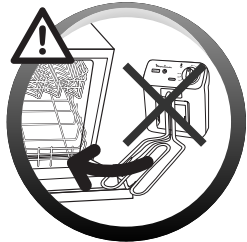
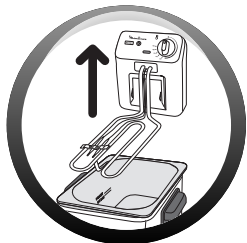

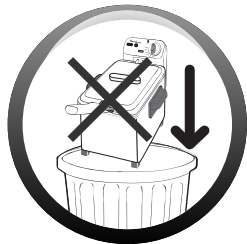
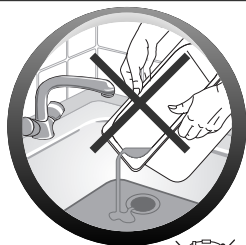
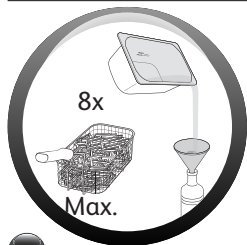
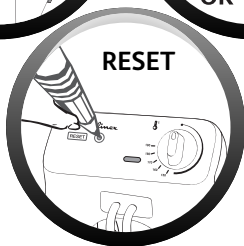
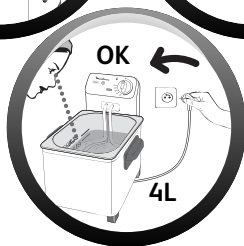
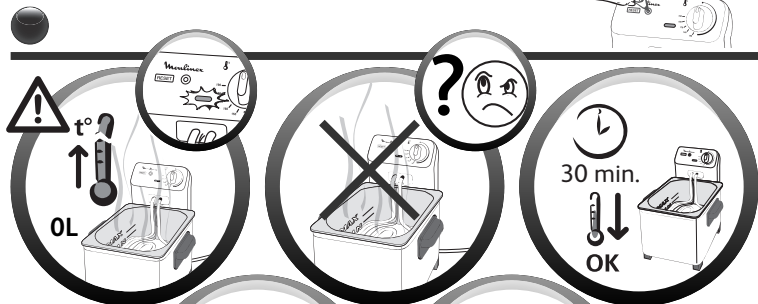
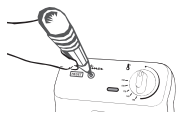

Moulinex[®]
pro first

Ref. NC00114835

www.moulinex.com