

# SMART CLEAN

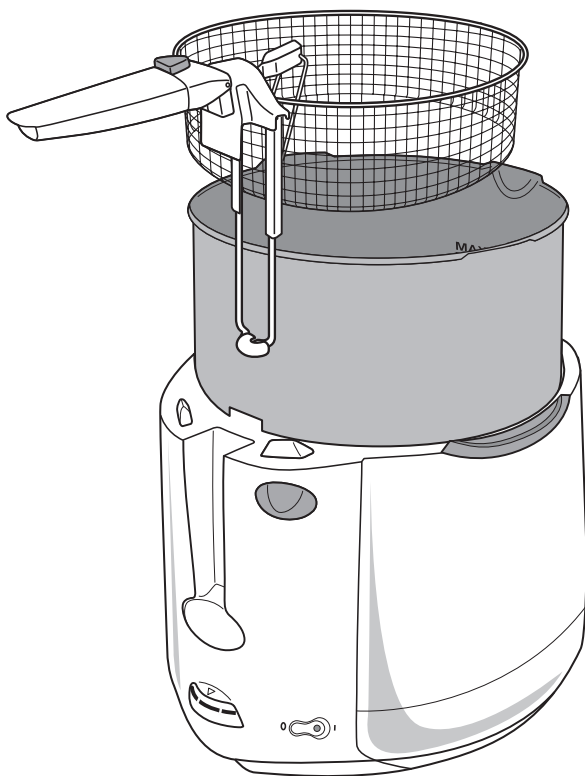

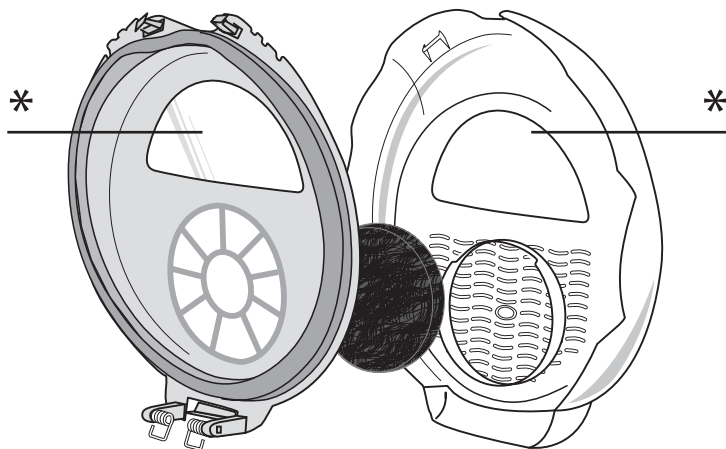

\*selon modèle • depending on model • je nach Modell • a seconda del modello • según modelo • consoante os modelos • Ανάλογα με το μοντέλο • В зависимости от модели • Залежно від моделі • zależnie od modelu • az egyes modellek szerint • podle modelů • podľa modelov • В зависимости от моделиге • În funcție de model • modellere göre • Зависно од модела • zavisno od modela • Ölede na model • بر حسب الموديل • بر حسب مدل

1

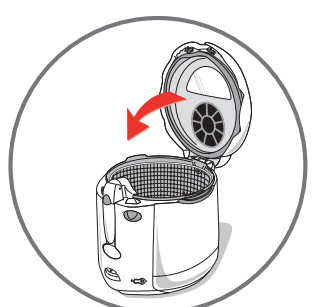
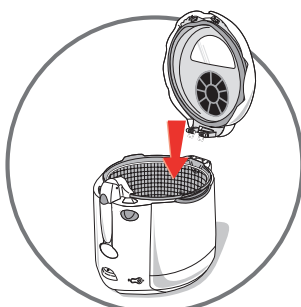
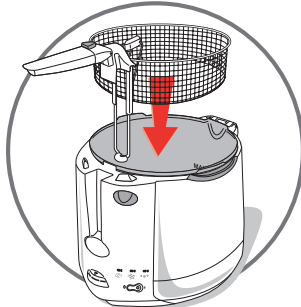
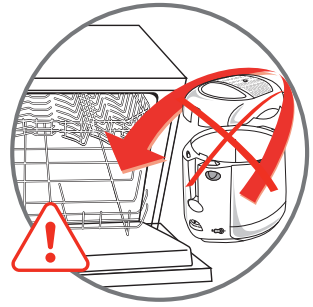
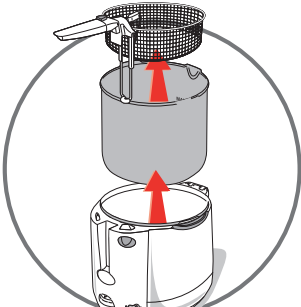
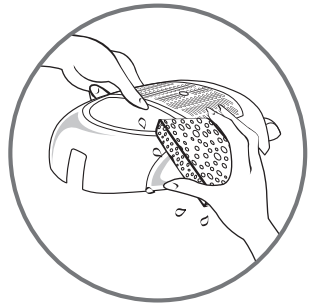
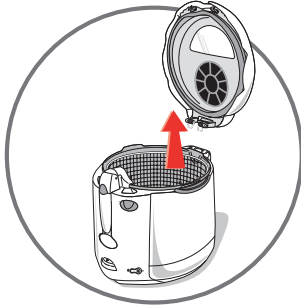
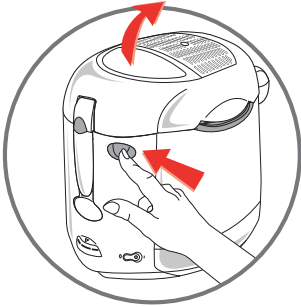
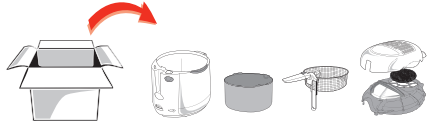



Min 2,3 L  
↓  
Max 2,5 L

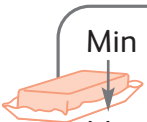
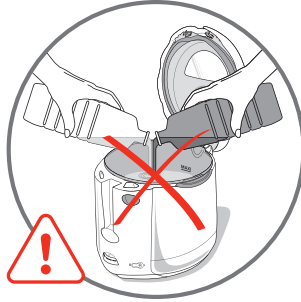
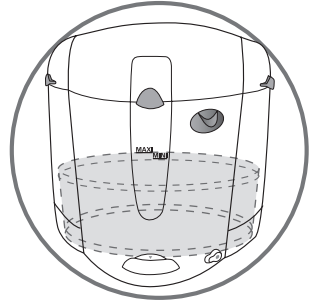
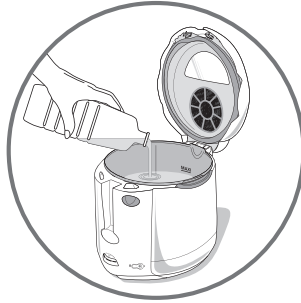

Min 2030 g  
↓  
Max 2160 g

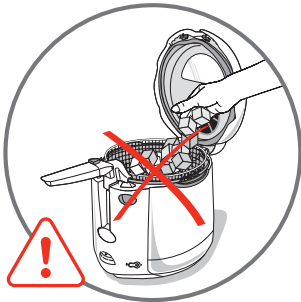
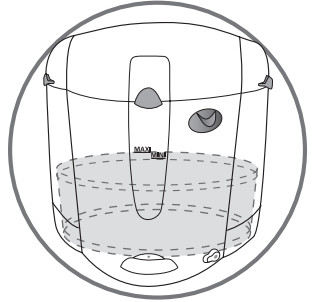
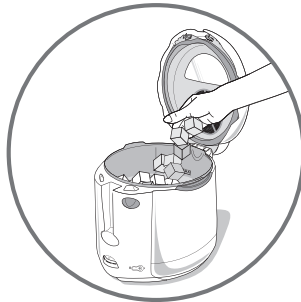

3

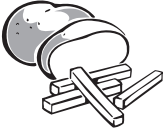

Max 1250 g



670 g

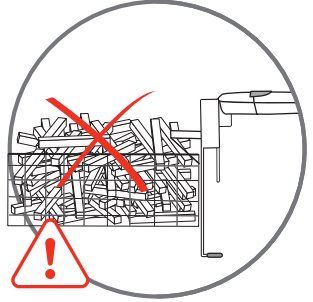
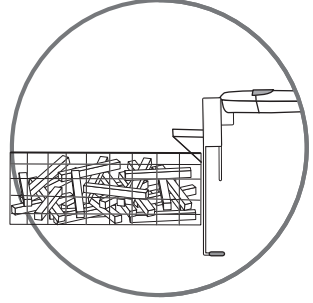

Max 900 g





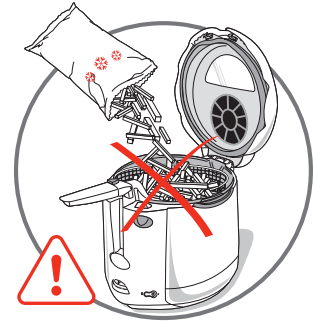
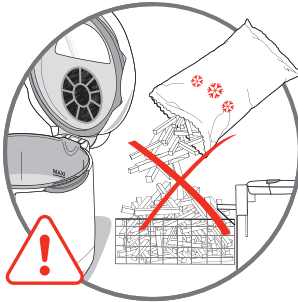
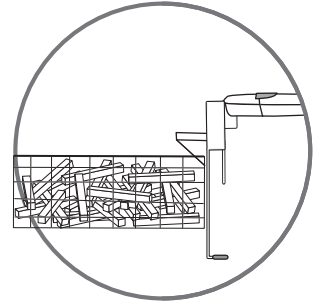

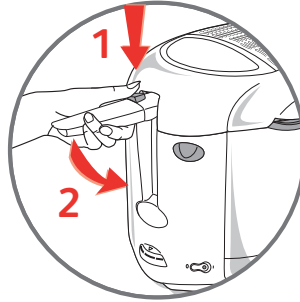
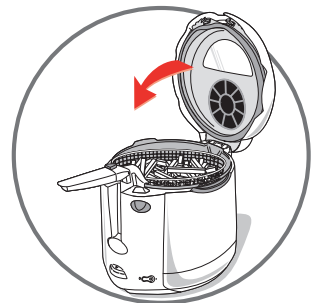
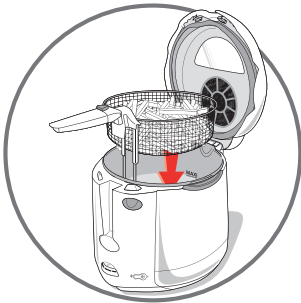
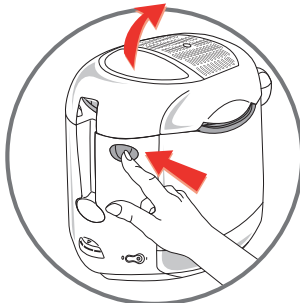
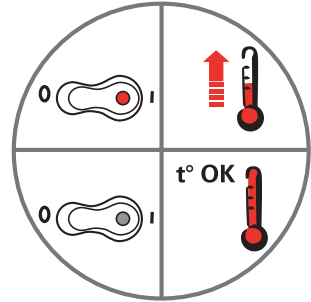
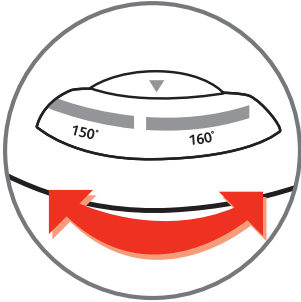
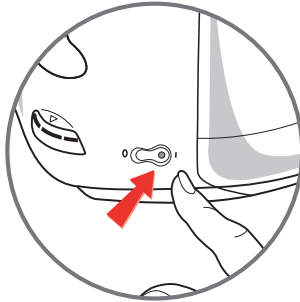
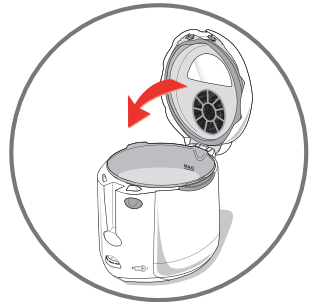
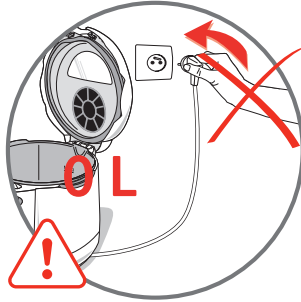
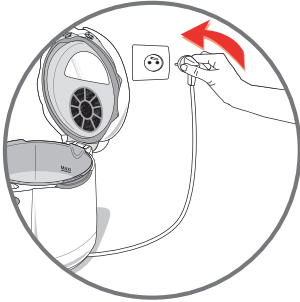

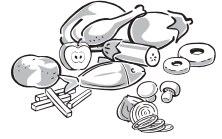









500 g







					
		 °C		 °C	
	670 g	170°C	13 - 15 min		
	1000 g	190°C	12 - 15 min		
	1250 g	190°C	16 - 17 min		
	500 g			190°C	8 - 9 min
	900 G			190°C	13 - 14 min
	8 - 10	190°C	8 - 9 min	190°C	10 - 13 min
	1 - 2	180°C	12 - 15 min	190°C	11-13 min
	200 g	190°C	3 - 4 min	190°C	5 - 6 min
	250 - 350 g	170°C	4 - 6 min	190°C	5 - 7 min
	250 - 300 g	170°C	10 - 12 min	170°C	6 - 8 min
	250 - 300 g			190°C	4 - 5 min
	450 - 480 g	170°C	6 - 8 min	190°C	5 - 6 min
	200 g	150°C	4 - 6 min	150°C	5 - 6 min
	200 g	170°C	3 - 4 min	170°C	3 - 4 min

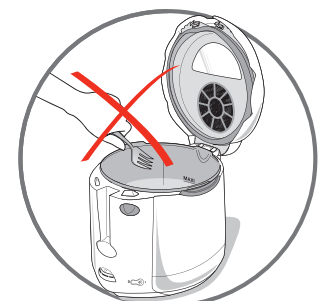
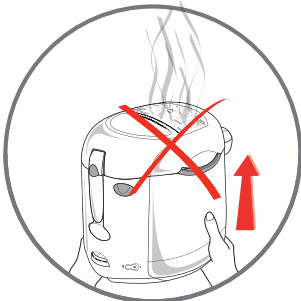
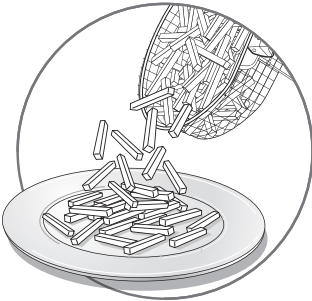
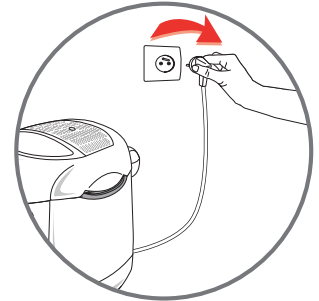
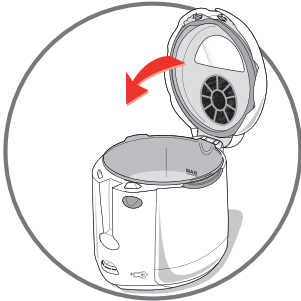
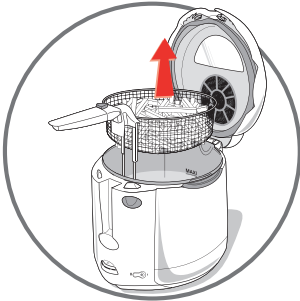
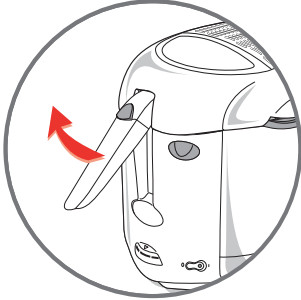
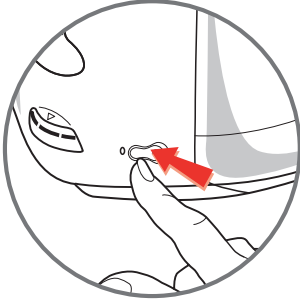
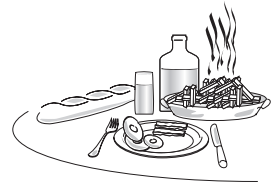



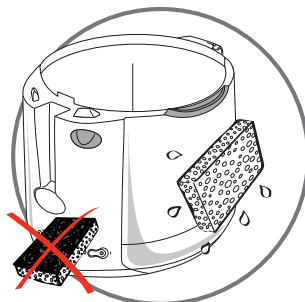
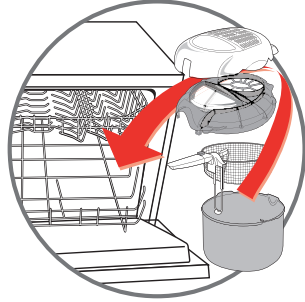
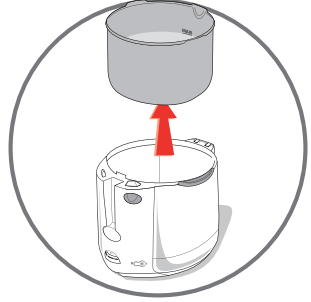
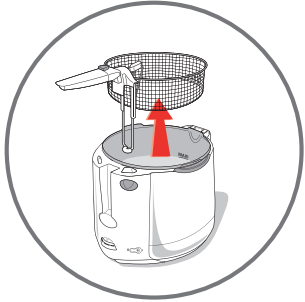
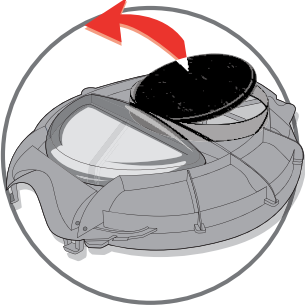
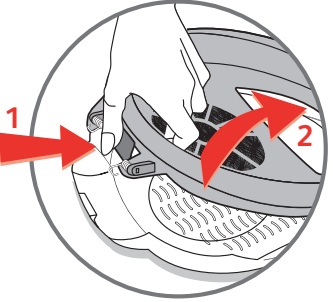
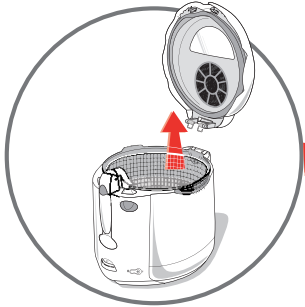
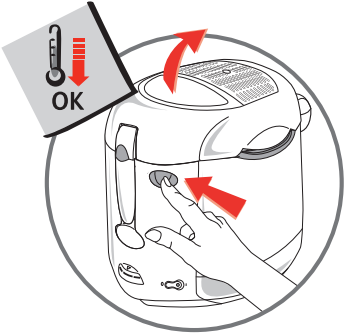
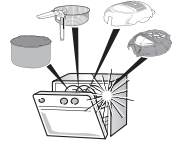

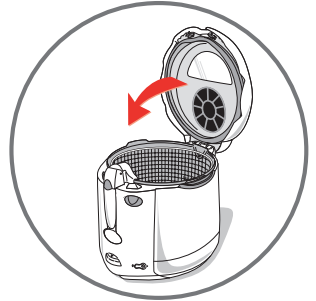
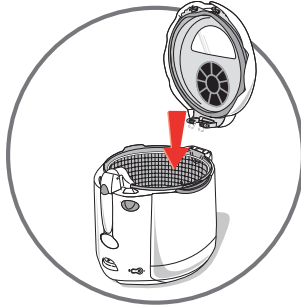
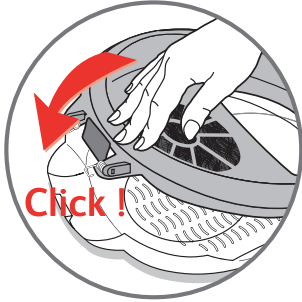
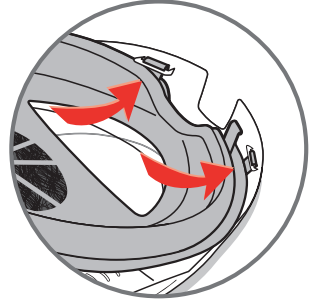
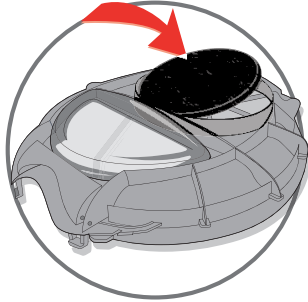
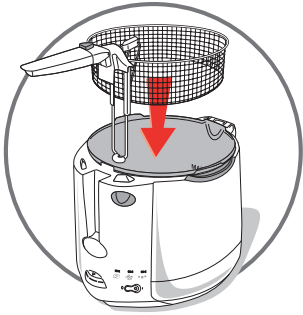

8

---

