

Tefal®

OLEOCLEAN DELUXE





*selon modèle • depending on model • je nach Modell • a seconda del modello • según modelo • consoante os modelos • Ανάλογα με το μοντέλο • В зависимости от модели • Залежно від моделі • zależnie od modelu • az egyes modellek szerint • podle modelu • podľa modelov • В зависимости от модели • În funcție de model • modellere göre • Зависно од модела • zavisno od modela • Ölede na model • بحسب الموديل • بحسب مدل

1

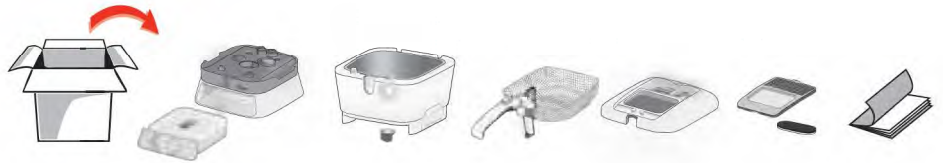

2

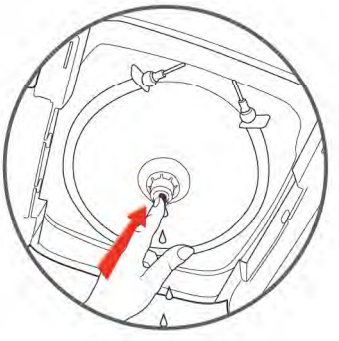
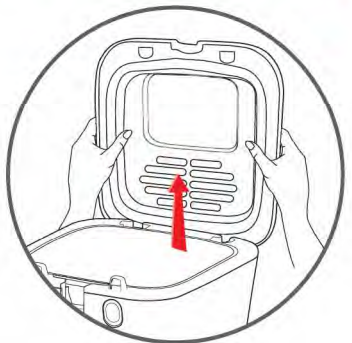
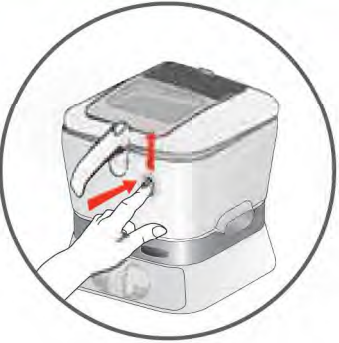

3

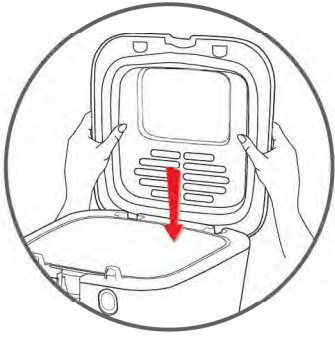

3



Min. 1,9 L
↓
Max. 2,1 L

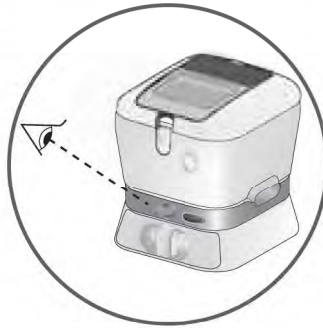

4

Min. 1600 g



Max. 1800 g

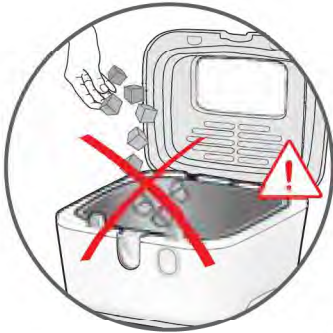
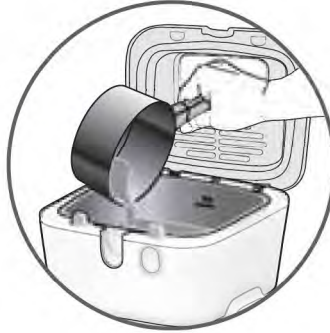
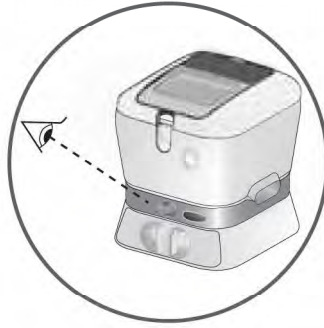



Max. 1000 g



750 g

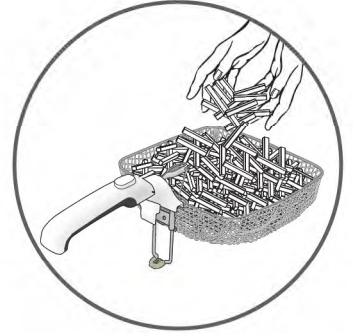
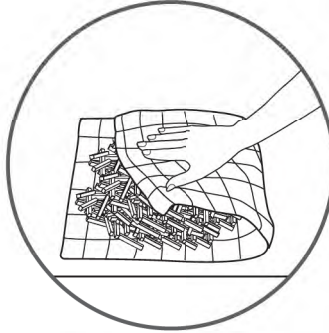

Max. 1000 g



500 g

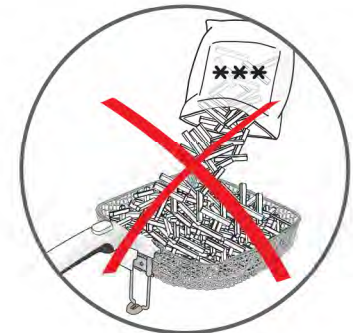
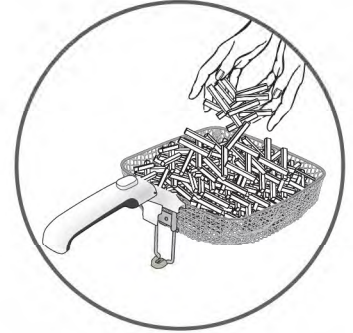
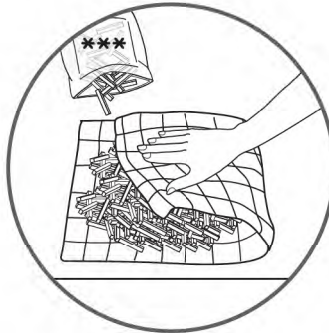

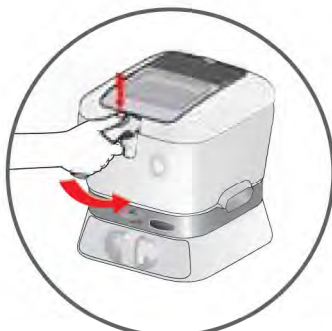
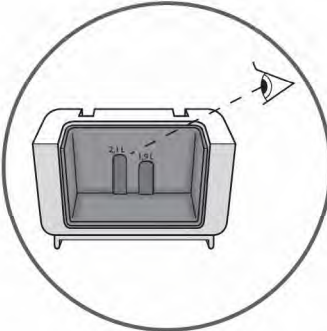



6

	nb			
		1000 g	170°C	16-17 min.
		750 g	170 °C	13-15 min.
		500 g	170°C	11-12 min.
	3-4 pcs		180 °C	18-20 min.
	1-2 pcs		170 °C	6-8 min.
	6 pcs		190 °C	2-3 min.
	8 pcs		150 °C	6-8 min.
	4 pcs		180 °C	6-7 min.

* * *	nb			
		1000 g	170 °C	17-18 min.
		750 g	170 °C	11-13 min.
		500 g	170 °C	10-11 min.
		380 g	170 °C	9-10 min.
		1300 g	190 °C	5-6 min.
	10-12 pcs		190 °C	5-6 min.
	8-10 pcs		190 °C	3-5 min.
		200 g	190 °C	3-4 min.

8



7

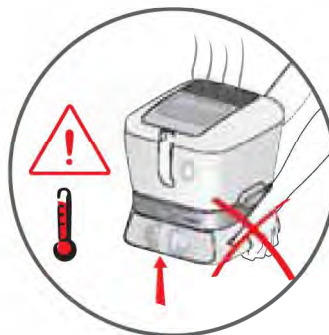
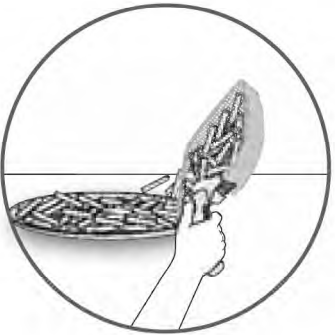
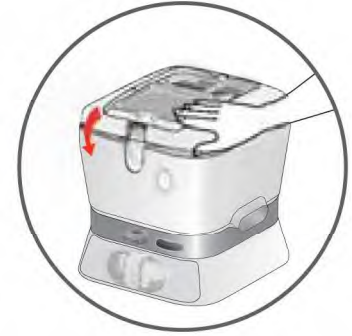

8

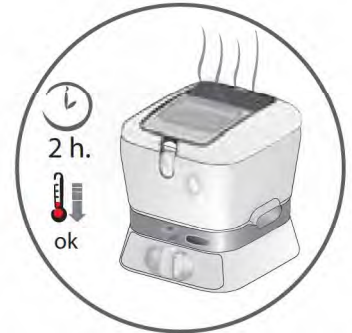

9

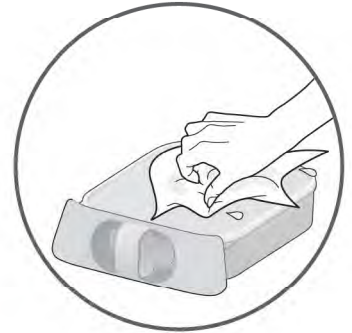
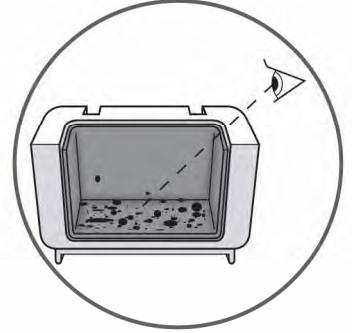
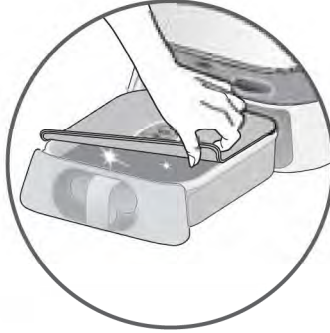
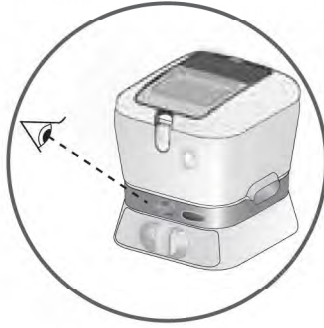
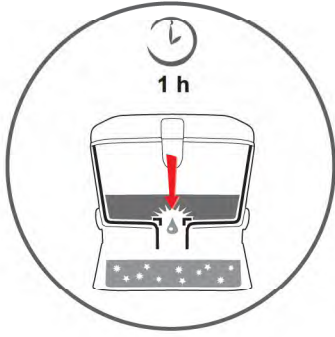

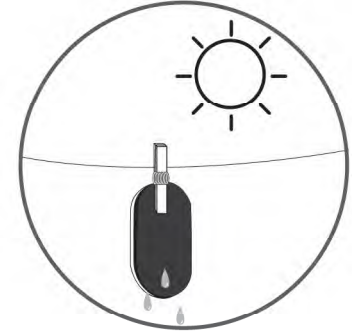
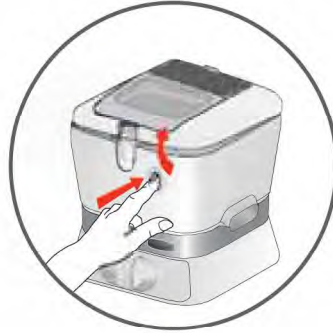



10

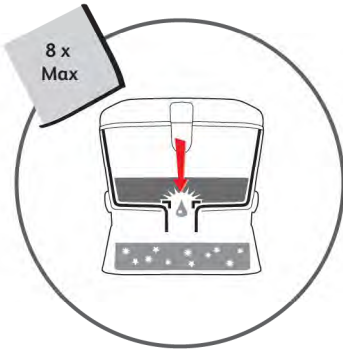

11



12



