



Pro Express Ultimate - GV9550

EN

Summary

1.	Safety instructions.....	04
2.	USING YOUR APPLIANCE.....	12
	2.1 Getting started	12
	2.2 Filling the water tank	15
	2.3 Transportation	17
	2.4 Settings	18
	2.5 Vertical steaming	20
	2.6 Auto-off.....	21
3.	MAINTENANCE AND STORAGE	22
	3.1 Emptying the calc collector	22
	3.2 Rinsing the boiler.....	24
	3.3 Cleaning	26
	3.4 Storage	27
4.	TROUBLESHOOTING	28

Important recommendations

- Please read these instructions carefully before first use. This product has been designed for domestic and indoor use only. Any commercial use, inappropriate use or failure to comply with the instructions, the manufacturer accepts no responsibility and the guarantee will not apply.
- Never unplug the appliance by pulling the power cord. Always unplug your appliance:
 - before filling the water tank or rinsing the boiler,
 - before cleaning the appliance,
 - after each use.
- The appliance will not work without the anti-calc collector (depending on model).
- The appliance must be used and placed on a flat, stable, heat and water resistant surface. When you place the iron on the iron rest, make sure that the surface on which you place it is stable.
- This appliance is not intended to be used by persons (including children) with reduced or impaired physical, sensory or mental capabilities or persons lacking appropriate knowledge or experience, unless a person responsible for their safety provides either supervision or appropriate instructions concerning use of the appliance prior to its use.
- Children should be supervised to ensure they do not play with the appliance.
- This appliance may be used by children aged 8 or over and persons lacking appropriate knowledge or experience

or persons with reduced or impaired physical, sensory or mental capabilities provided that they have been thoroughly instructed regarding use of the appliance, are supervised, and understand the risks involved. Children shall not play with the appliance. Cleaning and user maintenance shall not be made by children without supervision. Keep the iron and its cord out of reach of children less than 8 years of age when it is in use or cooling down.

-  The surfaces which are marked with this sign, the soleplate and steam cord are very hot during the use of the appliance. Do not touch these surfaces before the appliance has completely cooled down.
- Never leave the appliance unattended when it is connected to the mains. Before storing the appliance, once it is unplugged, please wait until it has cooled down (around 1 hour).
- Do not use any descaling products (vinegar, industrial descaling products, etc.) to rinse the boiler: they may damage the appliance.
- Before rinsing the boiler/rinsing the anticalc collector (depending on model), always make sure that the appliance is completely cooled down and has been unplugged for at least 2 hours before unscrewing the boiler rinse cap/or anti calc collector.
- Warning: if the boiler cap or the boiler rinse cap (depending on the model), is dropped or severely knocked, have it replaced by an Approved Service Centre, as it may be damaged.
- Never fill the appliance directly from the tap.
- The filling, or decalcifying, or rinsing, or inspection

apertures that are under pressure, must not be opened during use.

- The appliance must not be used if it has been dropped, if it has any visible damage, if it leaks, or if it functions abnormally in any way. Do not attempt to dismantle your appliance: have it examined at an Approved Service Centre to avoid any danger.
- Check the electrical power cord and steam cords for signs of wear or damage prior to use. If the electrical power cord or the steam cord is damaged, it must be replaced by an Approved Service Center to avoid any danger.
- Accessories, consumables and end user replaceable parts must be only purchased from an Approved Service Centre.
- For your safety, this appliance conforms to all applicable regulations (Low Voltage Directive, Electromagnetic Compatibility, Environment, etc).
- Your steam generator iron is an electrical appliance: it must be used under normal conditions of use. It is designed for domestic use only.
- It is equipped with 2 safety systems:
 - a pressure release valve designed to avoid excessive pressure. In the event of malfunction, the valve releases excess steam.
 - a thermal fuse to avoid overheating.
- Always plug your steam generator iron:
 - into a mains circuit with voltage between 220 V and 240 V (Alternating current only),
 - a socket outlet with an earth connection.

Connecting to the wrong voltage may cause irreparable damage to the appliance and will invalidate your guarantee.

- Do not use an extension lead. If you accept liability for doing so, only use an extension lead which is in good condition, has a plug with an earth connection and is suited to the power rating of the appliance.
- Completely unwind the power cord before plugging into an earthed socket outlet.
- The soleplate of your iron, the steam cord, and the iron rest on the base unit can reach extremely high temperatures, and can cause burns: do not touch them. Never touch the electrical power cords with the sole plate of the iron.
- Always use a vented/mesh ironing board to prevent water spots on clothes and to avoid hot steam venting sideways.
- Your appliance emits steam, which can cause burns. Always handle the iron with care, especially when ironing vertically.
Never direct the steam towards people or animals. Never iron clothing on a person, always use a hanger. Never iron in a seated position with your legs under the iron board.
- Never immerse your steam generator iron in water or any other liquid. Never place it under a running tap.

What water to use?

- Tap water: Your appliance has been designed to use untreated tap water. If your water is very hard, mix 50% untreated tap water and 50% bottled demineralised water. In some coastal areas, the salt content of the water may be high. In such cases, use only demineralised water.
- Water softener: There are several types of water softeners

available and most of them can be used in the generator. However, some softeners (especially those that use chemicals such as salt) may cause white or brown streaks. This is often the case when using water from filtering jugs. If you experience this sort of problem, we suggest you try using untreated tap water or bottled water.

- Attention: Never use rain water or water containing additives (such as starch, fragrances or water from household appliances). These additives may affect the properties of the steam, and together with high temperatures can cause deposits to form in the steam chamber which could stain your laundry and lead to premature aging of the appliance.

PLEASE RETAIN THIS INSTRUCTION BOOKLET FOR FUTURE REFERENCE



- Environment protection first !
- ① Your appliance contains valuable materials which can be recovered or recycled.
 - ➔ Leave it at a local civic waste collection point.

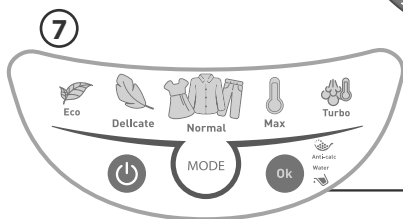
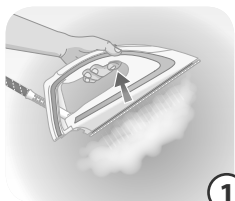

- 1 Steam trigger
- 2 Lock system
- 3 Water tank
- 4 Steam cord storage
- 5 Anti-calc collector
- 6 Electrical cord storage
- 7 Control panel

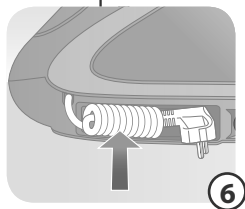

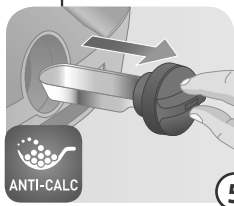
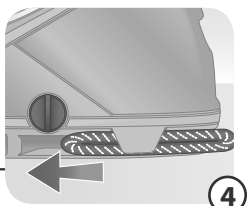
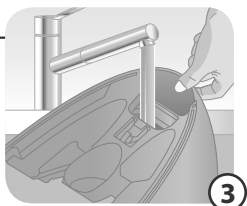
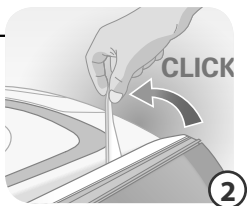
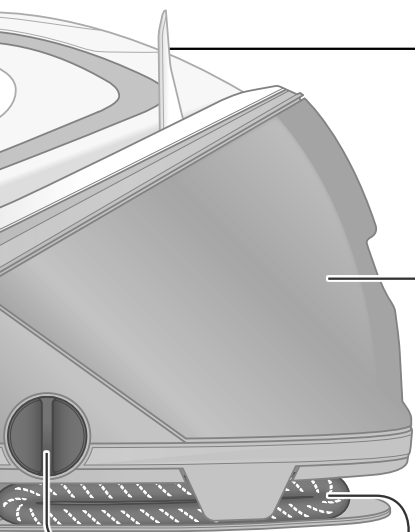

www.tefal.com



USING YOUR APPLIANCE

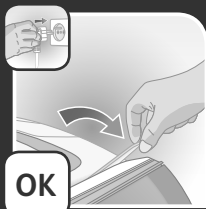
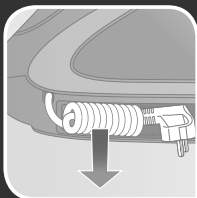
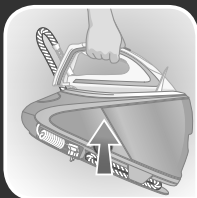

- Principle of ironing : start your appliance and put the fabric you want to iron on the ironing board. When the appliance is ready to use, put the iron on the fabric and start moving it from one side to the other. Pull the trigger to release steam.

2.1 Getting started

Pro Express Ultimate is equipped with a lock system to hold the iron onto the base for easy transport and storage.

- Unlock your steam generator.
- Completely unwind the power cord and take the steam cord out of its storage space.
- Fill the water tank with untreated tap water up to the max indication. Put the water tank back into the appliance by pushing in until it locks into place.
- Plug in your steam generator.

USING YOUR APPLIANCE

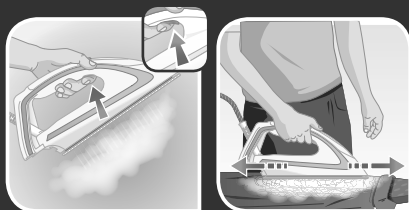
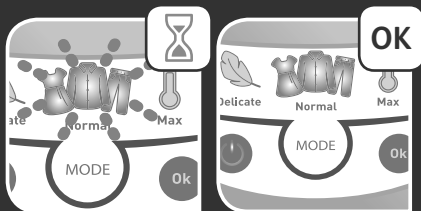
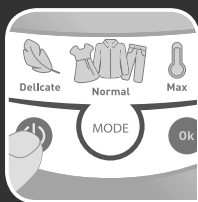

- Press the «ON-OFF» button on the control panel.
- The «ON-OFF» and the «Normal» button light remains flashing while the appliance is warming up.
- The steam generator is ready for use. The mode can still be switched even when the light flashes. After around 2 minutes, the light of the selected setting ECO (-20% energy savings vs Max mode) / DELICATE / NORMAL / MAX remains lit.
- To obtain steam, press and hold the steam trigger under the iron handle. The steam will stop when you release the button.

USING YOUR APPLIANCE

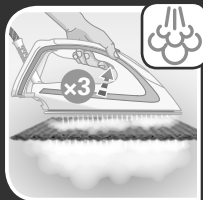

- To obtain even more steam, press the steam trigger under the handle three times in quick succession for automatic sequential steam.

During ironing, do not place directly the iron on the soleplate. Use the heel or the base.

USING YOUR APPLIANCE



2.2 Filling the water tank

- Fill the water tank before every use or when the « water tank empty » light flashes.
- Switch off and unplug the appliance.
- Remove the removable water tank using the handle located at the front of the steam generator
- Fill it with untreated tap water without exceeding the MAX level.
- Push it back into its housing until you hear a «click».

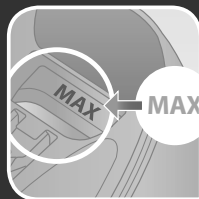
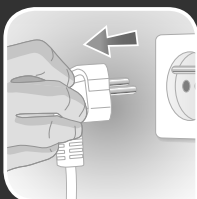
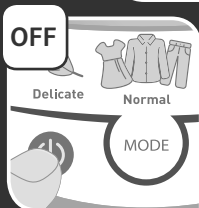

USING YOUR APPLIANCE

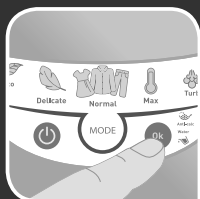
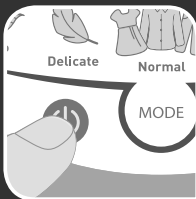
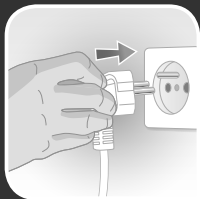

- Plug in the appliance.
- Press the «ON-OFF» button to restart the appliance.
- Red «water tank empty» light flashes on control panel.
- Hold down the «OK» button for a few seconds to turn off the red light.

USING YOUR APPLIANCE

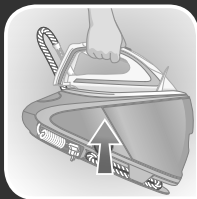

2.3 Transportation

Your steam generator is equipped with a lock system to hold the iron onto the base for easy transport and storage.

To transport your steam generator using the handle of the iron:

- Put the iron on the steam generator iron rest and raise the lock system over the iron until it locks into place (audible click).
- Hold the iron by the handle to transport your steam generator.

USING YOUR APPLIANCE



2.4 Settings

Changing modes

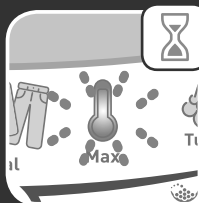
- Press the « MODE » button located on the control panel to go from one setting to another.
- When you press the MODE button to change mode, the light of the new mode flashes while the steam generator is adapting temperature and steam to the new setting. The steam generator is ready when the light stops flashing.



USING YOUR APPLIANCE

DELICATE	
NORMAL	
MAX TURBO	

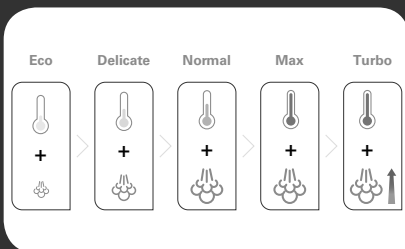

Choosing the adapted mode

- Check garment label. According to the type of fabric ironed, select the right setting on the appliance.
- Depending on which mode you select, the appliance will automatically adjust the temperature of the soleplate as well as the steam output.

USING YOUR APPLIANCE



2.5 Vertical steaming

As steam is very hot: never attempt to remove creases from a garment while it is being worn, always hang garments on a coat hanger.

- To use the vertical steam, put the appliance on "Normal" mode.
- Hang the garment on a coat hanger and hold the fabric slightly taut with one hand.
- Holding the iron in a vertical position tilted slightly forwards, press repeatedly on the steam control button (underneath the iron handle) moving the iron from top to bottom.

USING YOUR APPLIANCE

2.6 Auto-off

- The steam generator is fitted with an «AUTO-OFF» monitoring system, which is activated automatically after approximately 8 minutes without use. The «ON-OFF» button flashes to indicate that the appliance is on standby.
- To reactivate the steam generator, press the «ON-OFF» button.
- After approximately 38 minutes of non-use, the «AUTO-OFF» system switches off your steam generator.
- To start your ironing again, press the «ON-OFF» button.

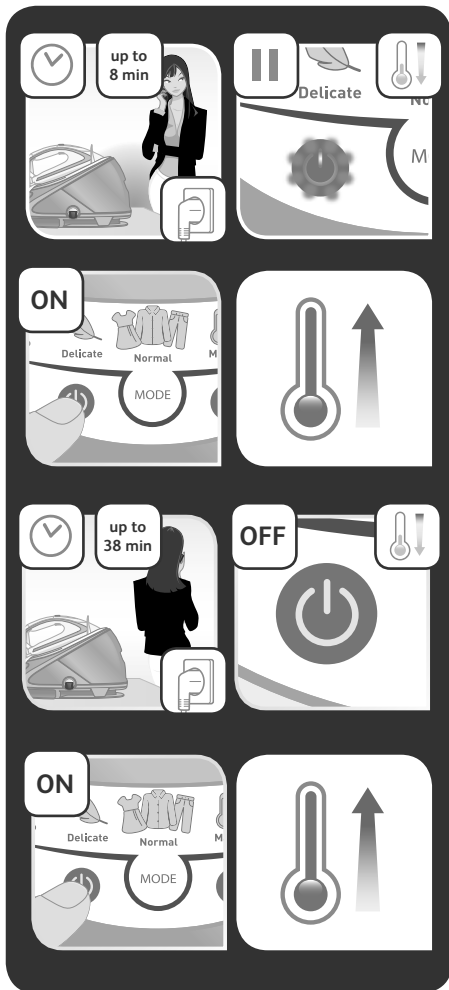

MAINTENANCE AND STORAGE

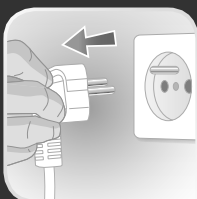
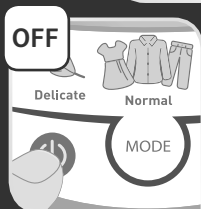

3.1 Emptying the anti-calc collector

- An orange «anti-calc» light located on the control panel starts flashing to inform that the anti-calc collector needs rinsing.
- Switch off and unplug the appliance.

Appliance has to be unplugged for at least 2 hours and be completely cool before continuing.

- Fully unscrew the anti-calc collector and pull it out of the base unit.

During this operation, water can drip from the anti-calc collector opening.

MAINTENANCE AND STORAGE

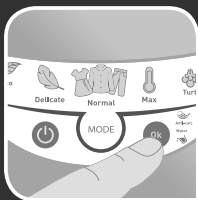
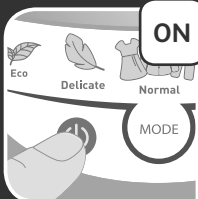
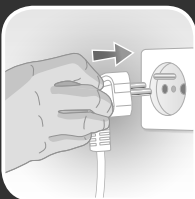

- To clean the collector, rinse it under running water to remove any calc it contains .
- Place the collector in its housing by screwing it in completely to ensure it is watertight.
- Plug the appliance.
- Press «ON-OFF» button to restart appliance.
- Orange «Anti-Calc» light flashes on control panel
- Hold down the «OK» button for a few seconds to turn off the orange light

MAINTENANCE AND STORAGE

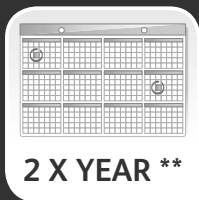

3.2 Rinsing the boiler

- In addition to this regular maintenance, it is advisable to rinse the boiler tank out completely every 6 months or after approximately 25 uses, whichever is the sooner.
- Switch off and unplug the appliance.

Appliance has to be unplugged for at least 2 hours and be completely cool before continuing.

- Fully unscrew the anti-calc collector and pull it out of the base unit.

During this operation, water can drip from the anti-calc collector opening.

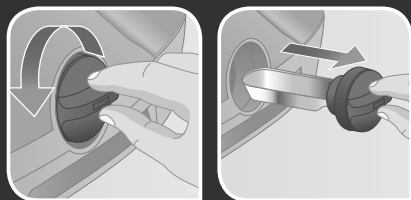
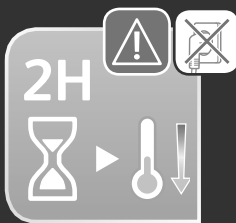
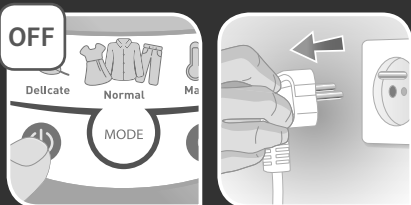

MAINTENANCE AND STORAGE

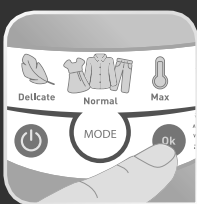
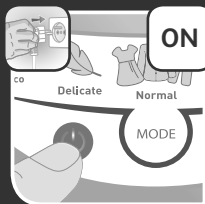

- Place the steam generator on the edge of your sink and hold your steam generator in an inclined position. Use a jug to fill the boiler tank with 1/4 litre of untreated tap water.
- Shake the base unit gently for a few seconds and then empty it completely into the sink.
- Place the anti-calc collector in its housing by screwing it in completely to ensure it is watertight.
- Plug in the appliance.
- Press «ON-OFF» button to restart the appliance.
- Press the «OK» button if the anti calc light flashes.

MAINTENANCE AND STORAGE

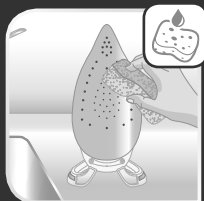
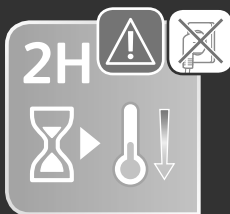

3.3 Cleaning

Appliance has to be unplugged for at least 2 hours and be completely cool before continuing.

- Clean soleplate with a soft damp cloth.

Do not use detergent or descaling products for cleaning the soleplate.

- Clean the plastic parts of the appliance occasionally with a soft cloth.

Never hold the iron or the base unit under the tap.

MAINTENANCE AND STORAGE

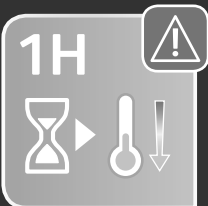
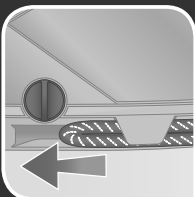
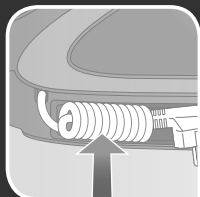
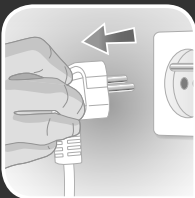
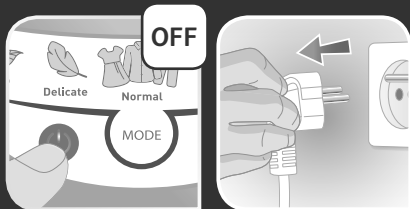

3.4 Storage

- Switch off and unplug the appliance.
- Store the power cord in its slide storage place.
- Store the steam cord in its slide storage place without stretching it too much.
- Put the iron on the steam generator iron rest and raise the retaining hoop over the iron until it locks into place (audible click).
- Leave the steam generator to cool (around 1h) then empty the watertank before putting it away if you are storing it in a cupboard or a confined space.

If you store your steam generator in a relatively cold place (approximately $<10^{\circ}\text{C}$), put it in a warm place before starting your ironing.

TROUBLESHOOTING

Problem	Possible Causes	Solutions
Water runs out of the holes in the soleplate.	The water has condensed in the pipes because you are using steam for the first time or you have not used it for some time.	Press the steam control button holding the iron away from your ironing board until the iron produces steam.
Water streaks appear on the laundry.	Your ironing board cover is saturated with water because it is not suitable for use with a steam generator.	Check that your ironing board is suitable (vented/mesh type ironing board to avoid condensation).
White streaks come out of the holes in the soleplate.	Your water tank has a build-up of scale because it has not been rinsed out regularly.	Rinse the anti-calc collector (see the "descaling your generator" section or "rinse the boiler". (depending on model).

Problem	Possible Causes	Solutions
Brown streaks come out of the holes in the soleplate and stain the laundry.	You are using chemical descaling products or additives in the ironing water. Over use of the steam button.	Never add any products to the water tank (see section on "What water to use?"). Do not hold down the steam button for too long, particularly whilst the pump is pumping more water into the boiler tank.
The soleplate is dirty or brown and may soil clothes.	You are ironing at too high a temperature.	Clean the soleplate as indicated in the user manual Use a lower temperature.
The soleplate is scratched or damaged.	You have positioned your iron flat on a metallic iron support or ironed over zips or metal fasteners.	Always stand the iron upright or on the iron rest.
The red "WATER" light is on.	The water tank is empty.	Fill the water tank.
The "anti-calc" light flashes.	You have not pressed the "OK" restart button.	Press the "OK" restart button on the control panel until the light goes out.

Problem	Possible Causes	Solutions
The steam generator does not switch on or the iron indicator light and the "ON-OFF" light are not lit up.	The "AUTO-OFF" system was activated after 38 minutes of non-use and has switched off your steam generator.	Press the "ON-OFF" restart button located on the control panel.
The red "WATER" light is flashing and the "ONOFF" button does not work.	The appliance has been stored in a cold place (approximately <math><10\text{C}^\circ</math>).	Unplug the appliance Wait 3 hours for the appliance to reach room temperature.

If you have any problems or queries please call our Customer Relations team first for expert help and advice.

