

Easy Clean & Store

www.groupeseb.com

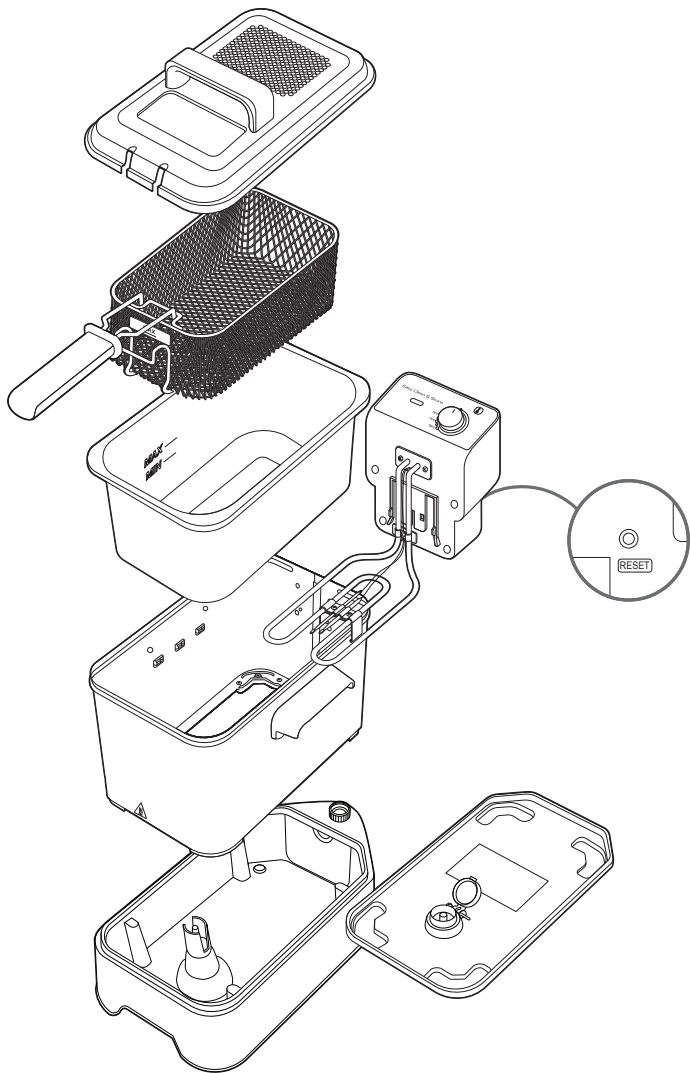

1

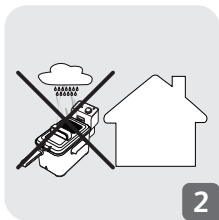
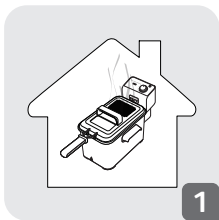

2

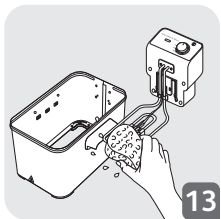
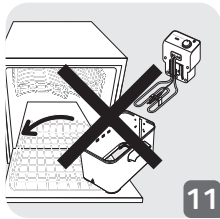
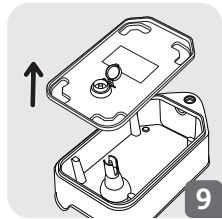
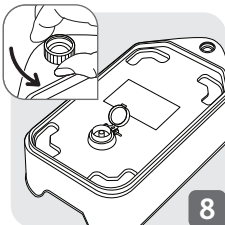
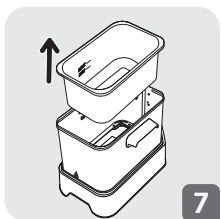
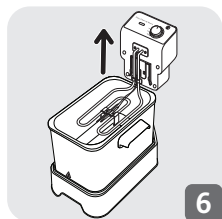
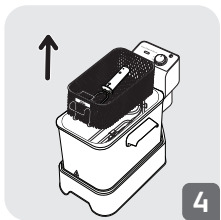
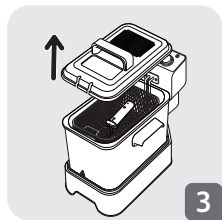
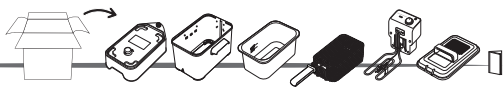

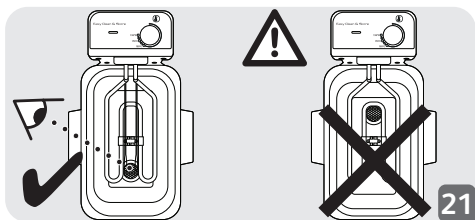
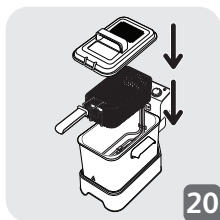
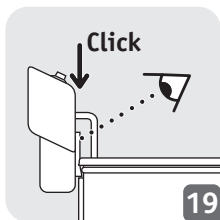
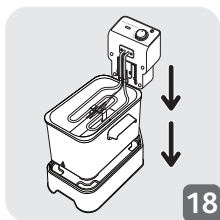
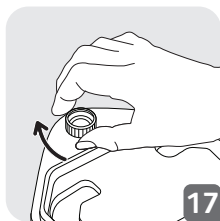
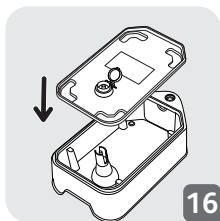



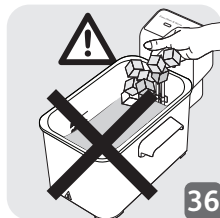
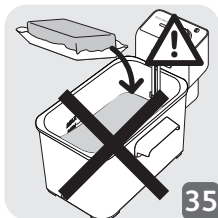
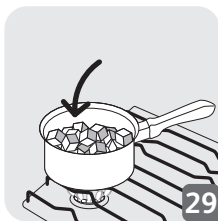
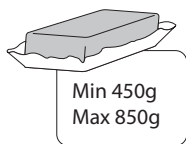



Max 1000g

600g

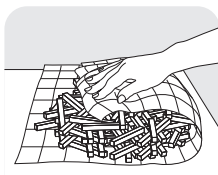

37

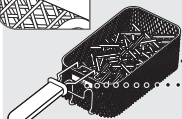

38



Max 750g

450g

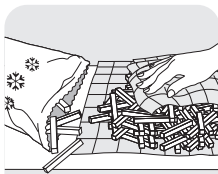

39

2/3
Max

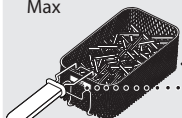

40

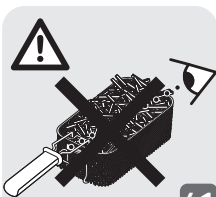

41

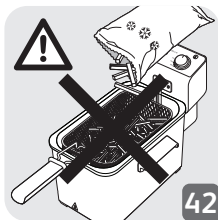

42



43

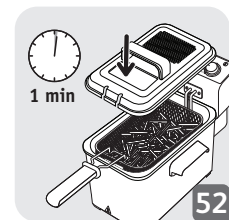
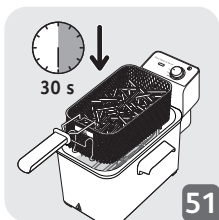
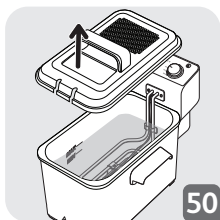
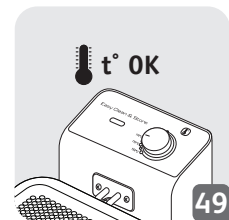
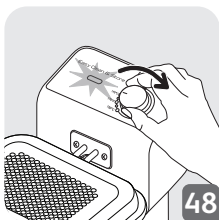
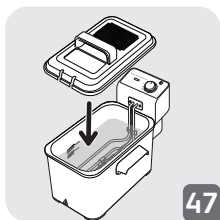
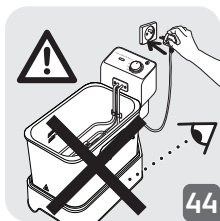

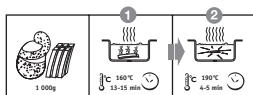

| | Nb | | | |
|--|----|-------|----------|-----------|
| | | 1000g | 1) 160°C | 13-15 min |
| | | | 2) 190°C | 4-5 min |
| | | 900g | 190°C | 14-16 min |
| | | 600g | 190°C | 14-16 min |
| | 8 | | 190°C | 13-15 min |
| | | 400g | 160°C | 6-8 min |
| | 6 | | 180°C | 8-9 min |
| | Nb | | | |
| | | 750g | 190°C | 15-16 min |
| | | 450g | 190°C | 12-14 min |
| | | 1200g | 190°C | 15 min |
| | | 900g | 190°C | 10-11 min |
| | | 450g | 190°C | 10-11 min |
| | | 500g | 180°C | 10-11 min |

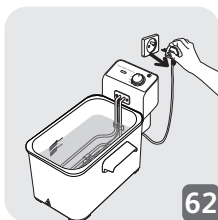
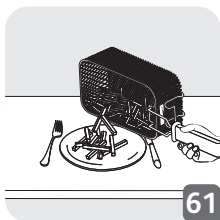
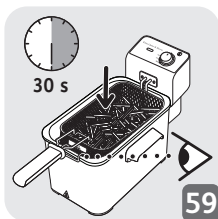
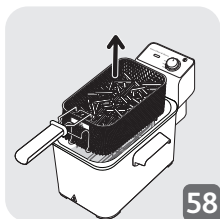
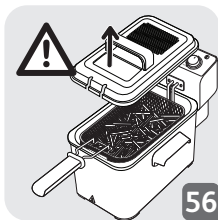
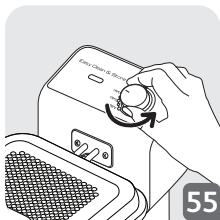

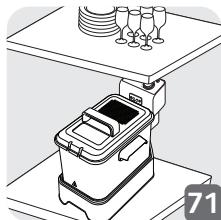
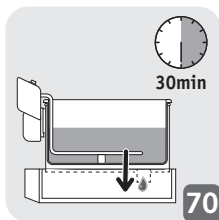
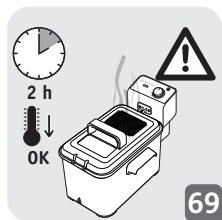
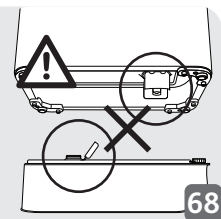
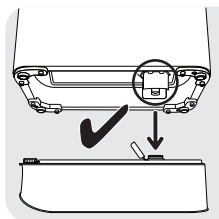
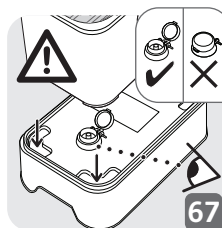
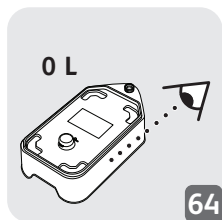

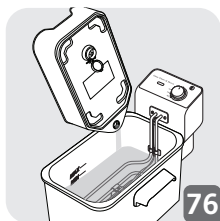
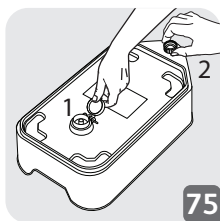
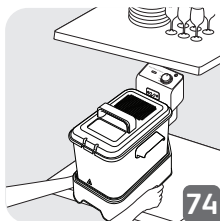
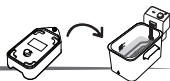
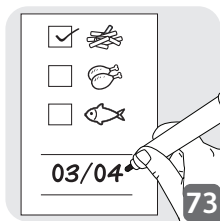

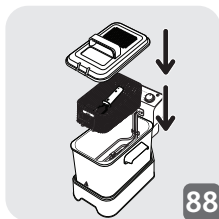
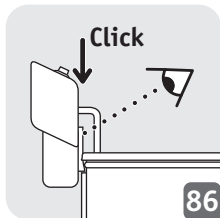
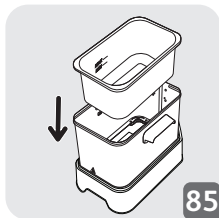
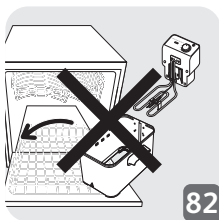
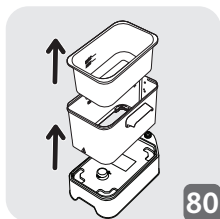
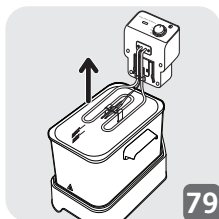
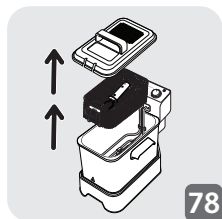

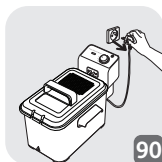



NC00148398