

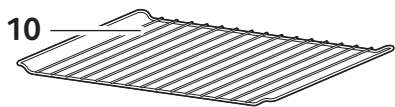

**Optimo 19L with turnspit**

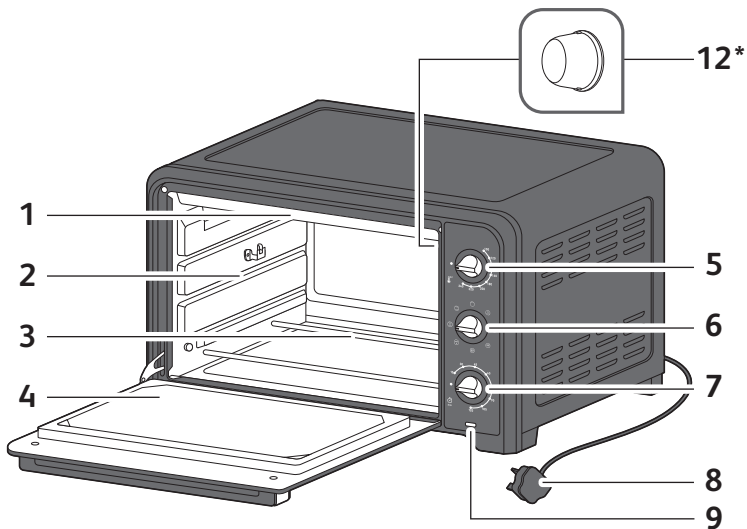

\* Depending on model

## DESCRIPTION

- |                            |                          |
|----------------------------|--------------------------|
| 1 Top heating element      | 8 Power cord             |
| 2 Aluminium walls          | 9 Power indicator light  |
| 3 Bottom heating element   | 10 Reversible grill rack |
| 4 Double-wall door         | 11 Baking tray           |
| 5 Temperature control knob | 12 Inner light*          |
| 6 Functions knob           | 13 Rotisserie            |
| 7 Timer knob               | 14 Rotisserie handle     |

\*Depending on model

## IMPORTANT PRECAUTIONS

- Make sure you read all the instructions.
- This appliance is not intended to function using an external time-switch or a separate remote control system.
- This appliance is not intended for use by persons (including children) with reduced physical, sensory or mental capabilities, or lack of experience and knowledge, unless they have been given supervision or instruction concerning use of the appliance by a person responsible for their safety.
- Children must be supervised to ensure that they do not play with the appliance.
- As this appliance is for household use only, it is not intended for use in the following applications and the guarantee will not apply for :
  - staff kitchen areas in shops, offices and other working environments;
  - farm houses;
  - by clients in hotels, motels and other residential type environments;

- bed and breakfast type environments.
- To ensure safety, if the power cord is damaged, it must be replaced by either the manufacturer, its approved service centre or similarly qualified persons.
- During use the rear face of the appliance must be placed towards a wall.
- Make sure that air can flow freely all around your appliance.
- The symbol  means: Caution, hot surface.
- Cleaning the appliance: the grid (and/or other removable parts) can be cleaned with a damp cloth and washing-up liquid. Clean the inside and outside of the appliance with a damp sponge or cloth.
- The light bulb must only be used for providing light to the oven. It should not be used on fittings for lighting rooms (according to model).
- The appliance is not intended for outdoor use.
- Do not use the appliance if:
  - it has a faulty or damaged power cord,
  - the appliance has been dropped and shows visible signs of damage or of malfunction.

In each of these cases, to avoid any risks to your safety the appliance should be sent to the nearest approved service centre.

- Unplug the appliance when you need to carry out major cleaning to the appliance, when you

need to change the light bulb or in the event of a thunderstorm.

- Do not remove the control buttons from the control panel when it is being cleaned.
- For your safety, never dismantle the appliance yourself; contact an Approved Service Centre.
- The appliance can be used up to an altitude of 4000 metres.
- This electrical appliance functions at high temperatures which may cause burns. Do not touch the metal parts or the glass door of your oven.
- This appliance can be used by children aged from 8 years and above and persons with reduced physical, sensory or mental capabilities or lack of experience and knowledge if they have been given supervision or instruction concerning use of the appliance in a safe way and understand the hazards involved. Children shall not play with the appliance. Cleaning and user maintenance shall not be made by children unless they are older than 8 and supervised.
- Keep the appliance and its cord out of reach of children less than 8 years.

-  • For your safety, this appliance meets applicable standards and regulations (Directives on Low Voltage, Electromagnetic Compatibility, Materials in contact with food articles, Environment.).
- Bearing in mind all the different standards in force, if this appliance is to be used in a country other than that where it was purchased, make sure it is checked by an approved service centre.
  - Do not move the appliance while it is in use.

- This appliance is not designed to be built in to other furnishing units. Place your oven on a flat, stable, heat-resistant work surface away from water splashes or on a kitchen unit which can tolerate a temperature of at least 90°C.
- We advise you when using for the first time, to operate your oven empty (without grill rack).
- Allow a distance of at least 2 cm between food articles and the upper heating element. It is quite normal if you notice a small amount of smoke or some smells of newness when you use your appliance for the first time, and this completely normal occurrence will quickly disappear.
- Check that the mains voltage corresponds correctly to that indicated on the appliance (alternating current only).
- Make sure that your electricity supply is sufficient for an appliance of this power.
- Do not allow the power cord to hang down or come into contact with the hot parts of the oven or rest on sharp edges.
- Do not unplug the appliance by pulling on the power cord.
- Only use an extension lead which is in good condition, has a plug with an earth connection and is suited to the power rating of the appliance.
- Unplug the appliance when it is not in use.
- In order to avoid the risk of electric shocks; do not immerse the cord, the plug or the appliance itself into water or any other liquid.
- Do not place the appliance close to any heat source or near to any electrical elements. Do not stand the appliance on top of any other appliance.
- Use the handles and the buttons; use oven gloves if necessary.
- Be careful when opening and closing the door of your oven: any violent shock or excessive stress caused by variations in temperature may break the glass parts. These parts are made of toughened glass in order to avoid any risk of glass being projected and thus avoid danger to the user.
- Never place any plates on the glass door of your oven when it is open.
- Should any parts of the product catch fire never try to extinguish the fire with water. Unplug the appliance and do not open the door. Smother the flames with a damp cloth.
- Never leave the appliance unattended when it is connected to the mains.
- Do not store any inflammable products close to or underneath the furniture unit where the appliance is located.

- Do not operate the appliance under a wall unit, shelving, or close to inflammable materials such as blinds, curtains, drapes...
- Do not use the appliance as a heat source.
- Never place paper, cardboard, or plastic in the appliance and never put anything on top of it (utensils, grill, objects, hot dishes after cooking...).
- Do not put any aluminium foil under the appliance to protect the work surface, nor between the heating elements, nor in contact with the inside walls or the elements, because you run the risk of seriously damaging the oven or the work surface.
- Never insert anything into the ventilation ducts and do not obstruct them.
- Do not use any powerful cleaning products (notably soda based cleaning products), nor brillo pads, nor scourers.

### Using the turnspit

- Be sure to use the baking tray during turnspit cooking to prevent grease from dripping on to the bottom heating element.
- When cooking with the turnspit, be sure that meat/poultry is not so large as to come into contact with the baking tray, thus obstructing the turnspit function.

### KEEP THESE INSTRUCTIONS IN A SAFE PLACE



#### Environment protection first!

- ① Your appliance contains valuable materials which can be recovered or recycled.
- ➔ Leave it at a local civic waste collection point.

This product has been designed for domestic use only. Any commercial use, inappropriate use or failure to comply with the instructions, the manufacturer accepts no responsibility and the guarantee will not apply.

### CLEANING AND MAINTENANCE

Unplug the appliance. Leave to cool for at least 20 minutes. Remove the wire rack and baking tray. Wipe the interior and glass door with a cloth, hot water and washing up liquid. Never use hard abrasive powders, wire wool, hard abrasive scourers, soda crystals or oven cleaner.

Clean the grill and baking tray with hot water and washing up liquid. If food burns onto the baking tray, leave it to soak in warm water before cleaning.

1

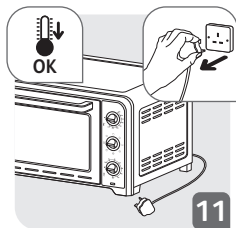
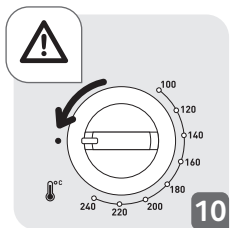
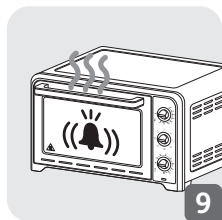
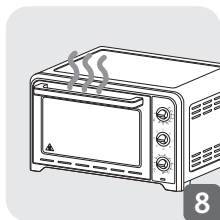
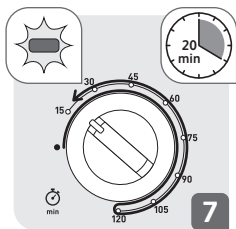
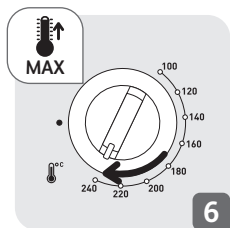
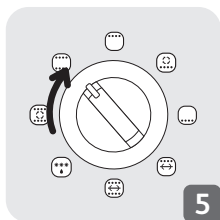
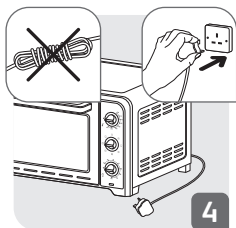
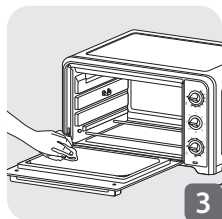
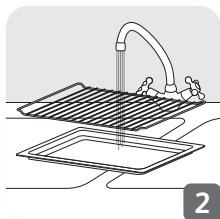
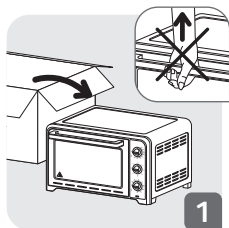

8



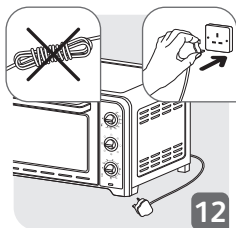

12

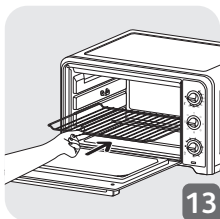

13

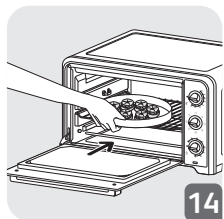

14\*\*

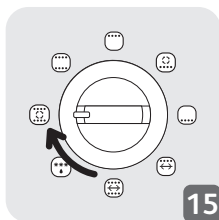

15

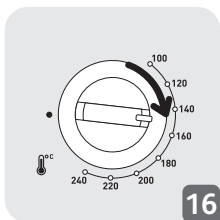

16

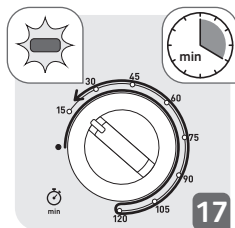

17

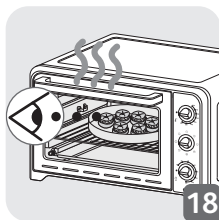

18

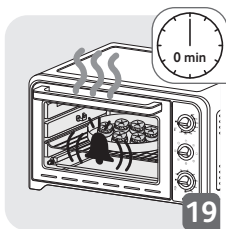

19

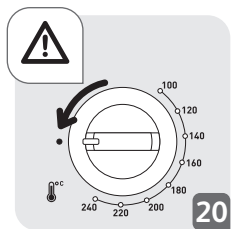

20

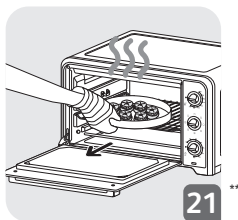

21\*\*

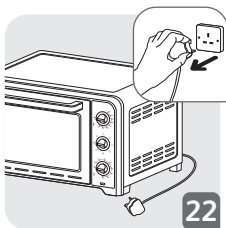

22

\*\* The dish is not supplied with the appliance

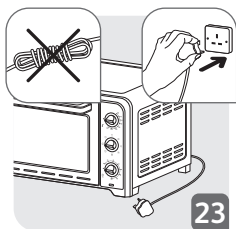

23

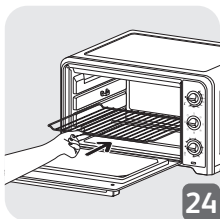

24

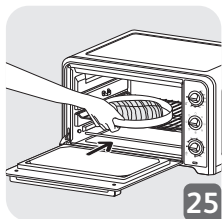

25\*\*

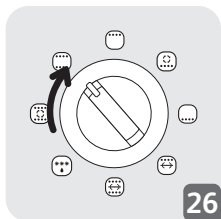

26

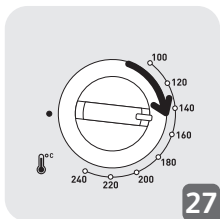

27

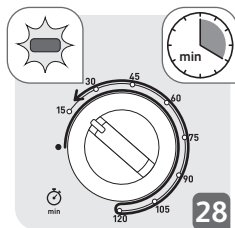

28

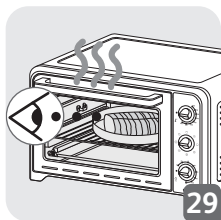

29

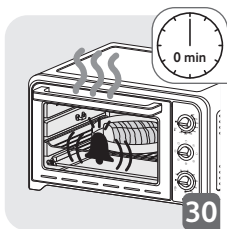

30

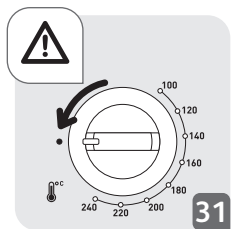

31

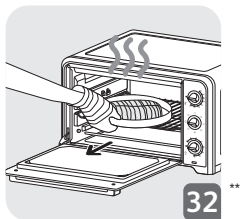

32\*\*

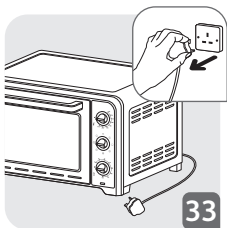

33

\*\* The dish is not supplied with the appliance

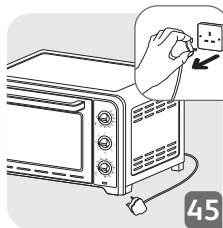
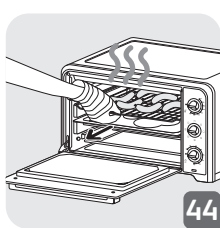
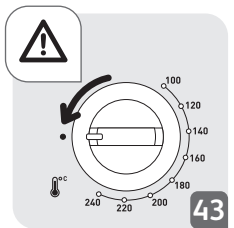
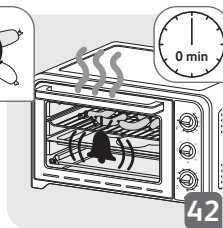
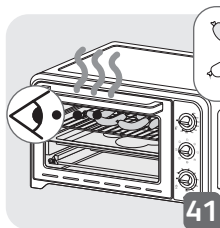
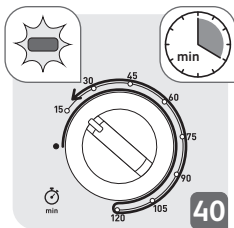
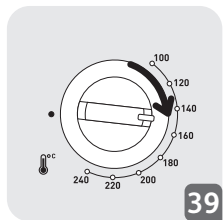
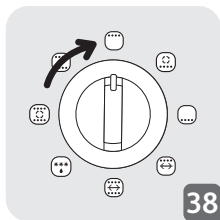
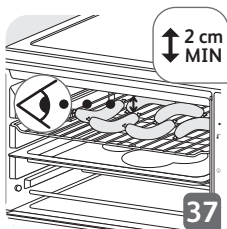
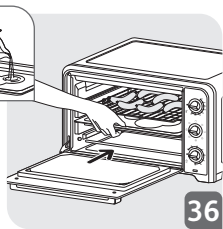
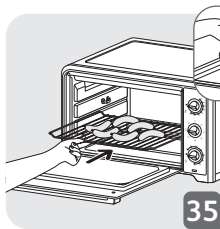
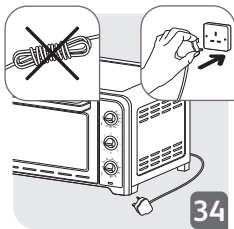

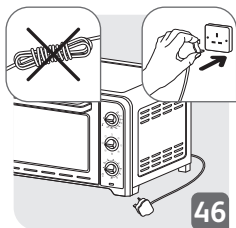

46

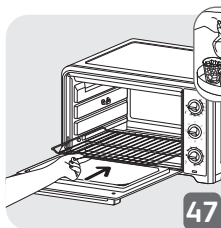

47

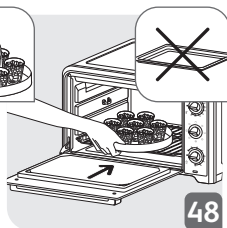

48\*\*

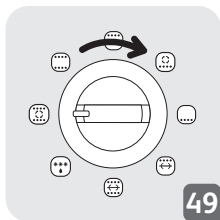

49

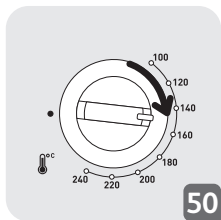

50

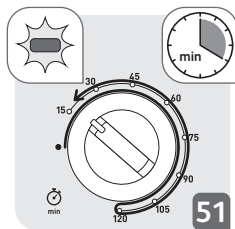

51

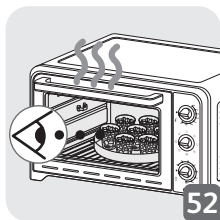

52

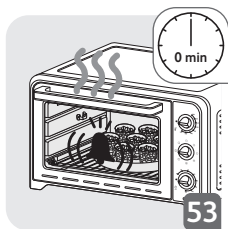

53

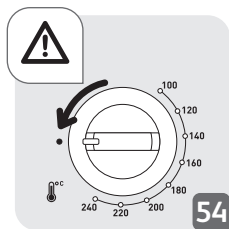

54

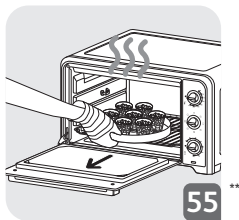

55\*\*

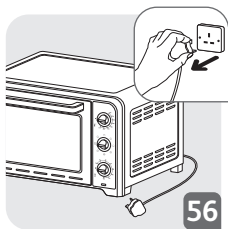

56

\*\* The dish is not supplied with the appliance

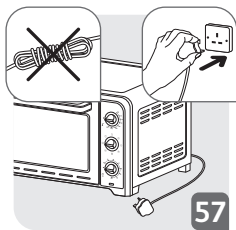

57

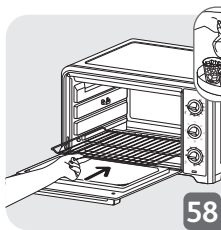

58

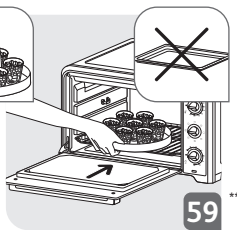

59\*\*

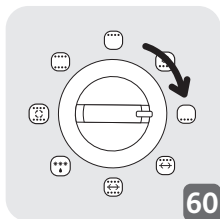

60

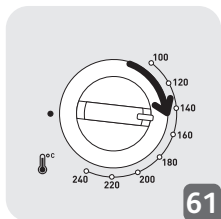

61

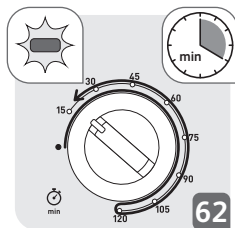

62

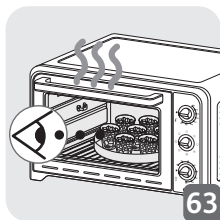

63

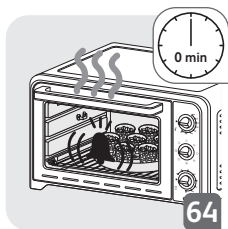

64

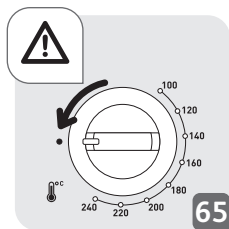

65

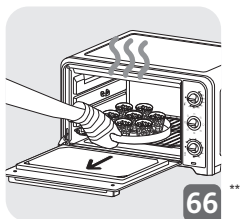

66\*\*

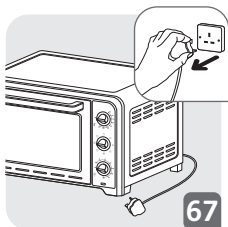

67

\*\* The dish is not supplied with the appliance

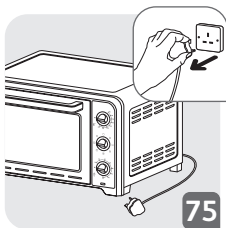
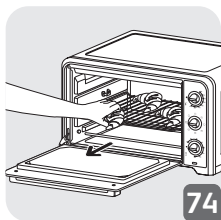
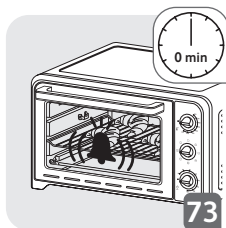
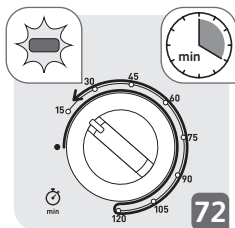
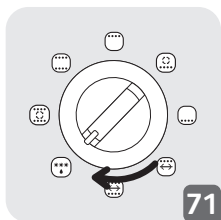
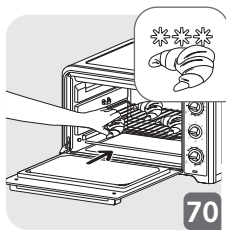
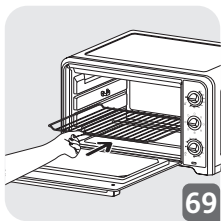
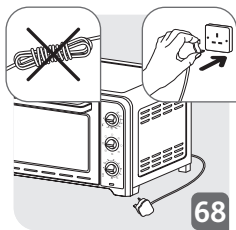

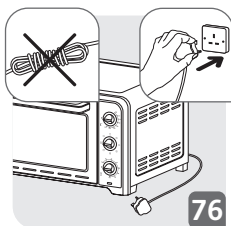

76

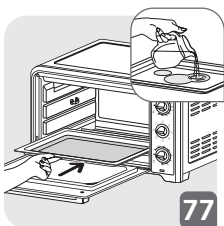

77

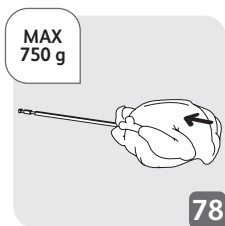

78

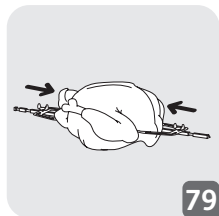

79

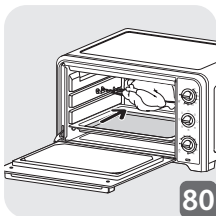

80

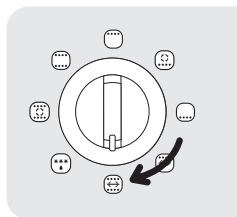

81

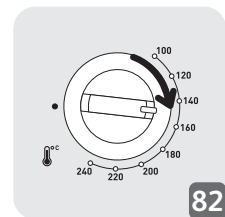
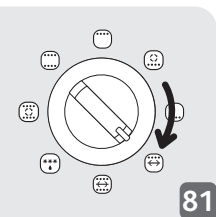

82

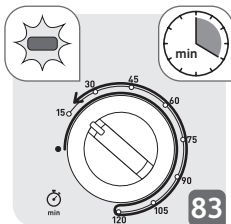

83

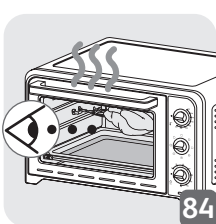

84

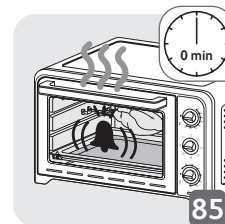

85

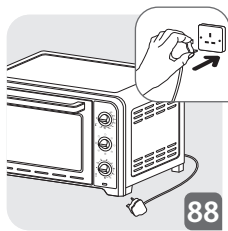
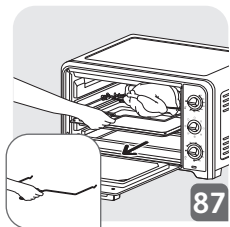
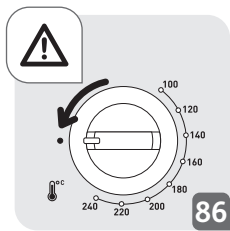



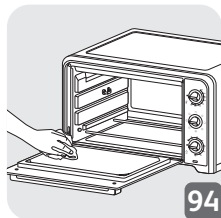
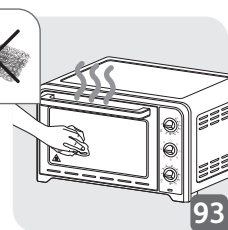
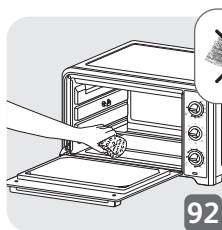
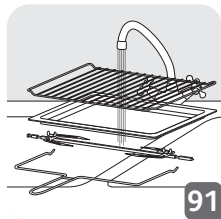
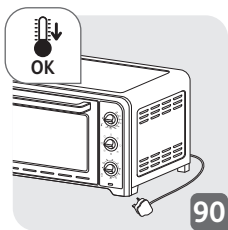
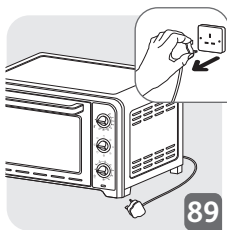



















9







	x4			10mins	240	20
	870g			10mins	230	65
	750g			10mins	240	42*
	500g			-	240	50
	1000g			-	240	80
	x4			-	240	22 ** 16
	x8			-	240	15 *** 8
	350g			10mins	210	11
				10mins	240	40
	350g			10mins	240	16
				-	240	31
				10mins	200	40
				10mins	200	25
				10mins	200	40

						
	x6			10mins	200	10
	x6			10mins	200	16
				10mins	240	55
				10mins	240	25
	750g			-	240	35
	300g			10mins	200	35

\* The cooking times for beef in the table above are for rare beef. Cook longer for well done meat.

\*\* cook for 22 min on one side, then turn and cook for 16 min.

\*\*\* cook for 15 min on one side, then turn and cook for 8 min.

