

# Tefal®

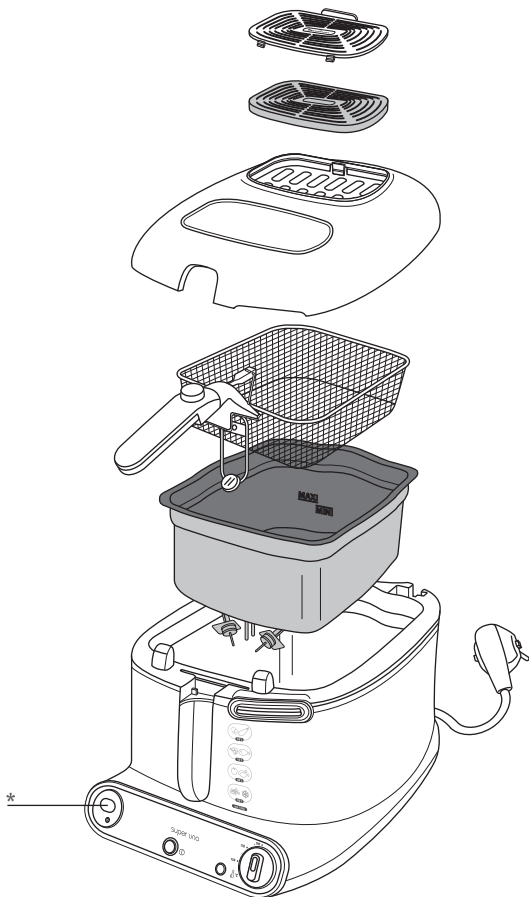

## Super Uno

[www.tefal.com](http://www.tefal.com)



\* Selon modèle • Afhankelijk van het model • Je nach Modell • Depending on model • Secondo i modelli • Según modelo • Consoante o modelo • ανάλογα με το μοντέλο • Modele göre • Afhängig af model • Beroende på modell • Avhenger av modell • Mallista riippuen • Ovisno o modelu • Zavisno od modela • в зависимости от модели • Odvisno od modela • W zależności od typu • Podle modelu • V závislosti od modelu • Modelltól függően • В зависимости от модели • Залежно від моделі • Ovisno o modelu • Sõltuvalt mudelist • Atbilstoši modelim • Pagal modelį • بر حسب الموديل • بر حسب مدل

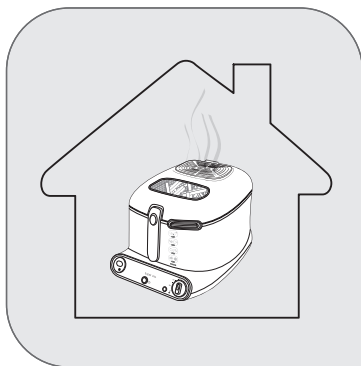

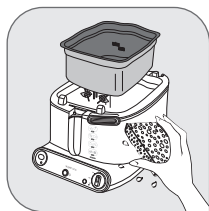
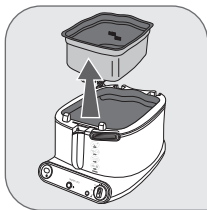
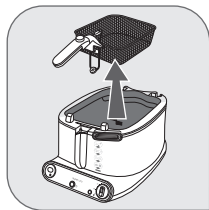
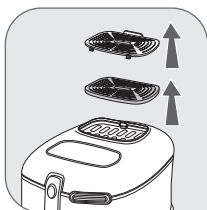
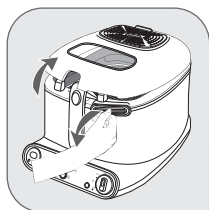
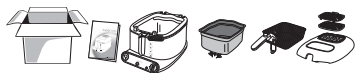

Min. 2 L / Max. 2,2 L

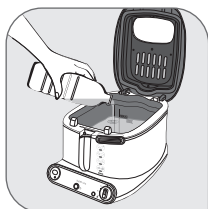

Min. 1,75 Kg / Max. 2 Kg

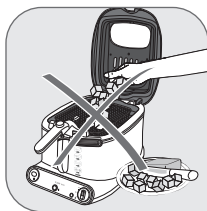
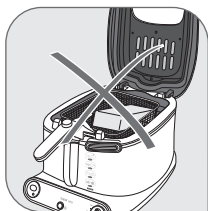
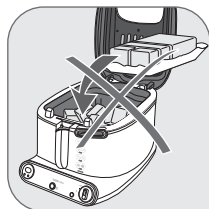
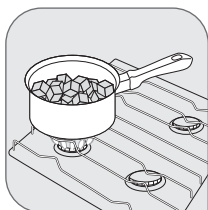



Max 1,4 Kg



700 g

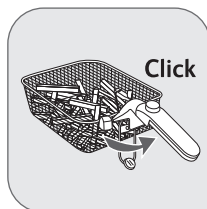
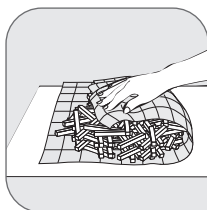

Max 1 Kg





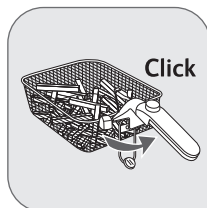
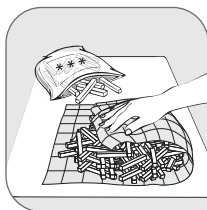

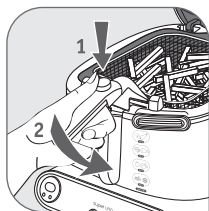
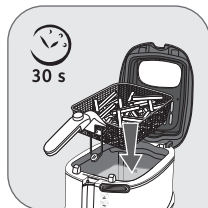
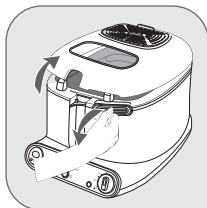
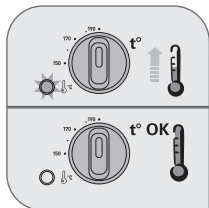
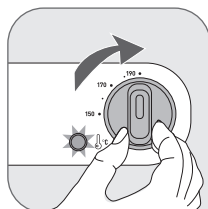
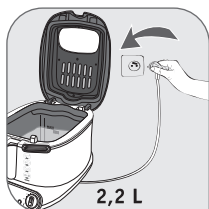













500 g









					
					
	1,4 kg	1 170° C 2 190° C	10 - 12 min 8 - 10 min	- -	- -
	1,3 kg	190° C	18 - 22 min	-	-
	700 g	190° C	8 - 12 min	-	-
	1 kg	-	-	190° C	14 - 17 min
	500 g	-	-	190° C	6 - 9 min
	3 - 4 p	180° C	14 - 16 min	190° C	14 - 15 min
	1,5 kg	-	-	190° C	12 - 16 min
	2 p	170° C	6 - 8 min	190° C	6 - 7 min
	8 p	-	-	190° C	5 - 7 min
	8 - 10 p	170° C	5 - 6 min	190° C	4 - 5 min
	8 - 10 p	170° C	5 - 6 min	190° C	4 - 5 min
	6 p	190° C	2 - 3 min	-	-
	8 p	150° C	5 - 7 min	150° C	5 - 6 min
	4 p	180° C	5 - 6 min	-	-

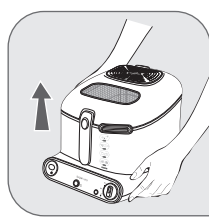
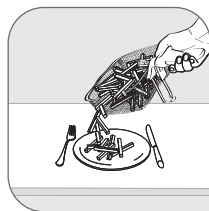
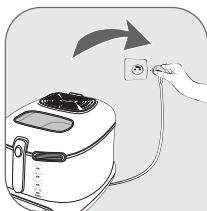
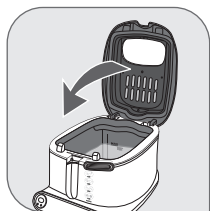
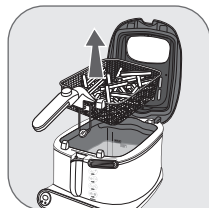
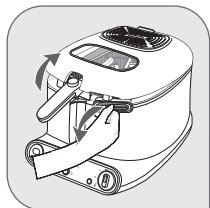
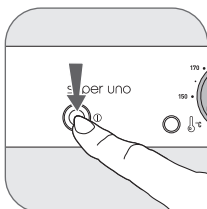
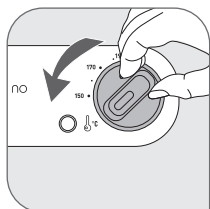

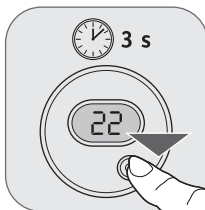
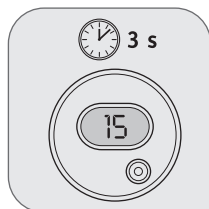
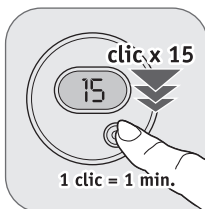
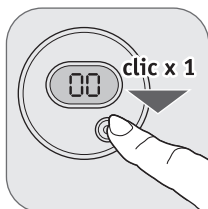

\* Selon modèle • Afhankelijk van het model • Je nach Modell • Depending on model • Secondo i modelli • Según modelo • Consoante o modelo • ανάλογα με το μοντέλο • Modelle göre • Afhængig af model • Beroende på modell • Avhenger av modell • Mallista riippuen • Ovisno o modelu • Zavisno od modela • в зависимости от модели • Odvisno od modela • W zależności od typu • Podle modelu • V závislosti od modelu • Modelltól függően • В зависимости от модели • Залежно від моделі • Ovisno o modelu • Sõltuvalt mudelist • Atbilstoši modelim • Pagal modelį • بر حسب الموديل • بر حسب مدل

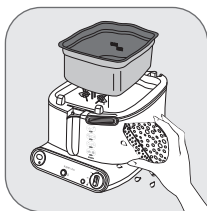
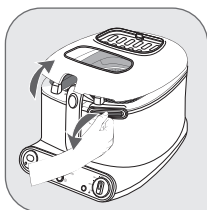
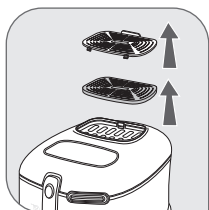

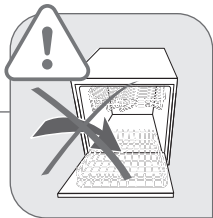
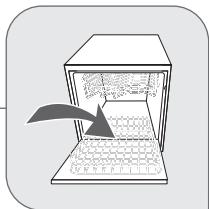
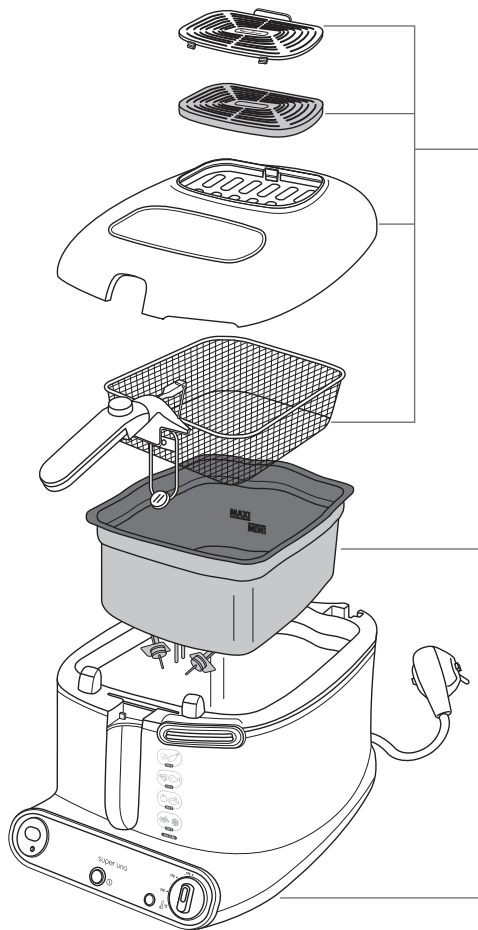

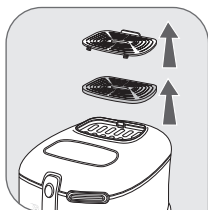
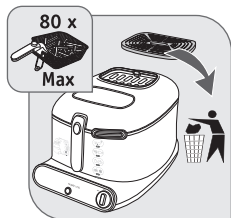
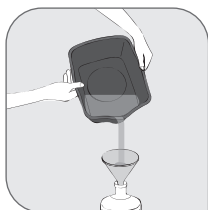

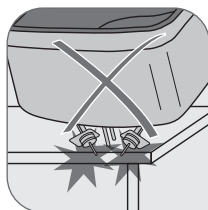
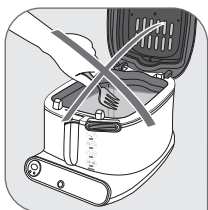

# Tefal®

NC00122942

[www.tefal.com](http://www.tefal.com)