

Moulinex
minuto

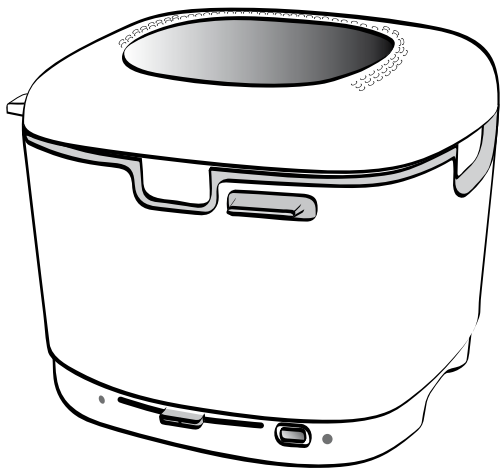

www.moulinex.com

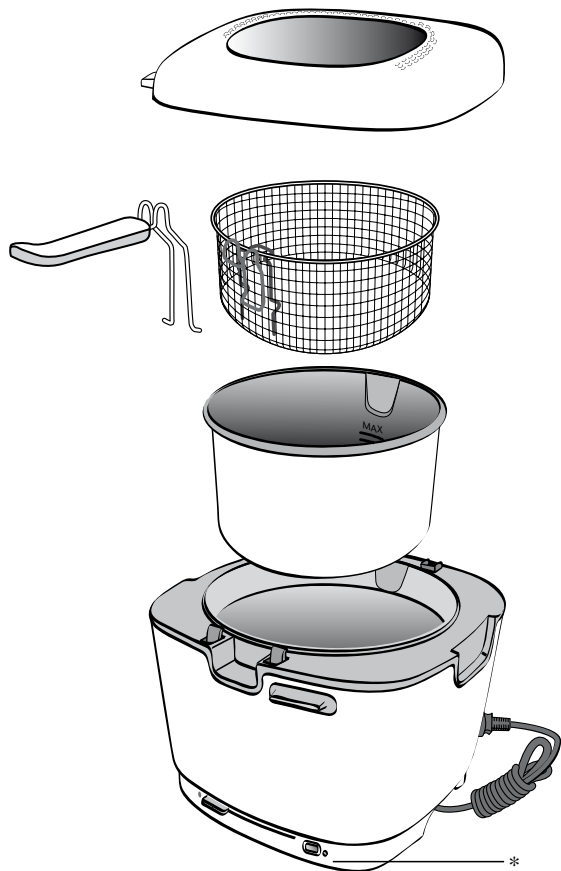

*selon modèle • depending on model • je nach Modell • a seconda del modello • según modelo • consoante os modelos • Ανάλογα με το μοντέλο • В зависимости от модели • Залежно від моделі • zależnie od modelu • az egyes modellek szerint • podle modelů • podľa modelov • В зависимости от модели • În funcție de model • modellere göre • Зависно од модела • zavisno od modela • Ölede na model • بر حسب الموديل • بر حسب مدل

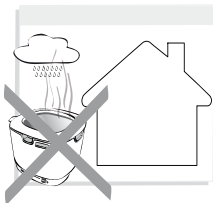

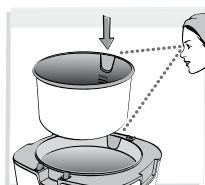
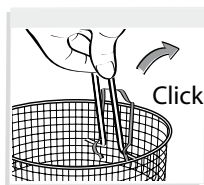
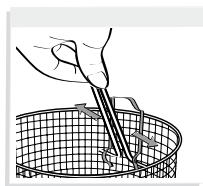
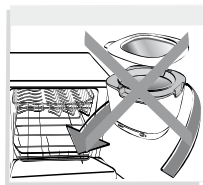
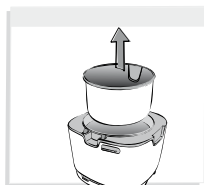
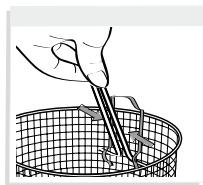
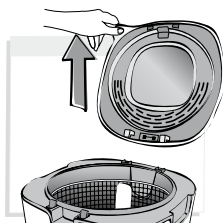
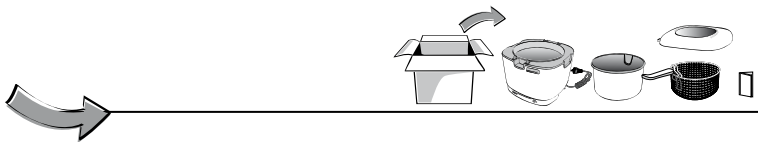



Min 0,8L

Max 1 L

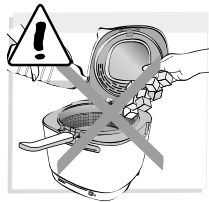
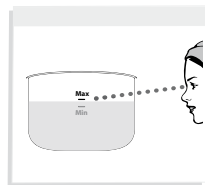

Min 700g

Max 900g

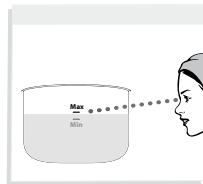
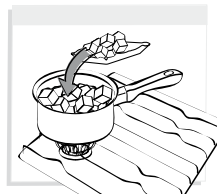



Max 400g



250g

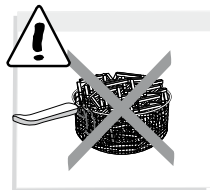
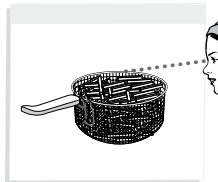
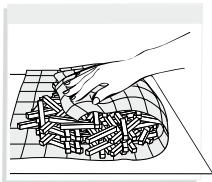

Max 300g



150g

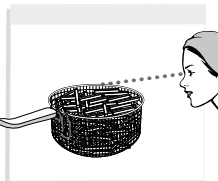
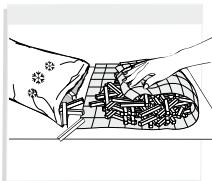
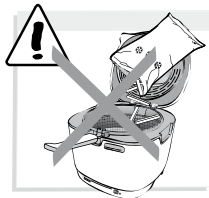

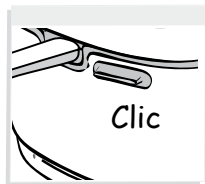
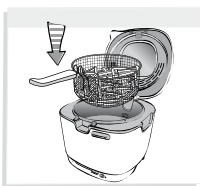
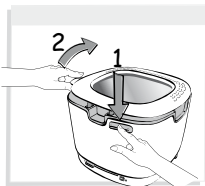
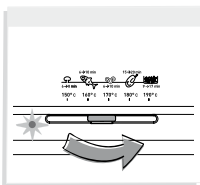
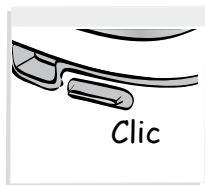
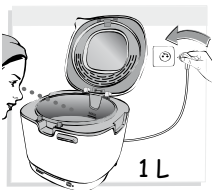
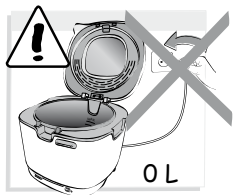



	Nb			
		400g	1) 160°C	8-9 min.
			2) 190°C	5-6 min.
		400g	190°C	10-12 min.
		400g	170°C	12-14 min.
	2-3		180°C	18-20 min.
	2		160°C	10-12 min.
	6-8		150°C	10-12 min.
	10-12		180°C	8-10 min.
	12		180°C	3-5 min.
	4		170°C	8-10 min.
* * *				
		300g	190°C	8-9 min.
		300g	170°C	13-15 min.
	2-3		190°C	22-25 min.
		500g	190°C	8-10 min.
	3		190°C	6-8 min.
		200g	190°C	5-7 min.
	5		190°C	5-7 min.

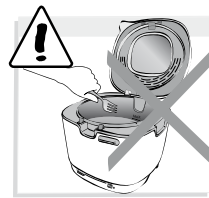
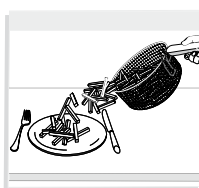
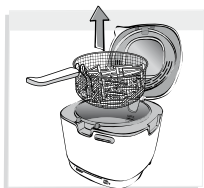
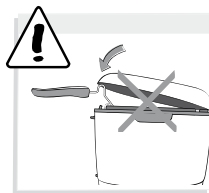
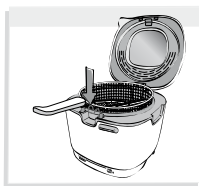
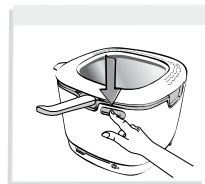
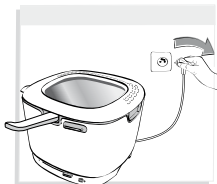
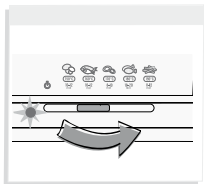

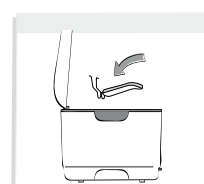
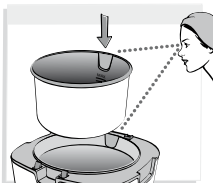
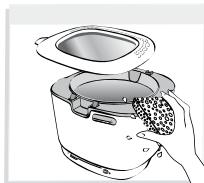
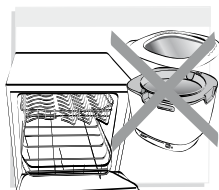
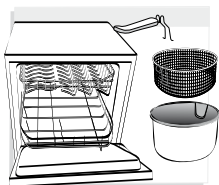
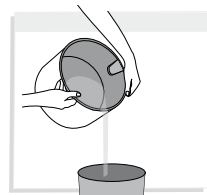
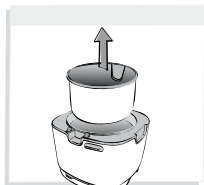
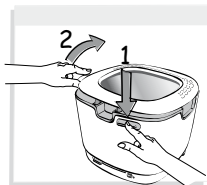

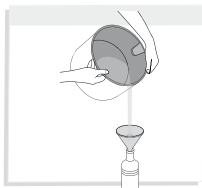

Référence : NC00012085
Conception : www.batoteam.fr

