

EN

ES



HORNO EXTRA GRANDE

www.t-fal.com.mx

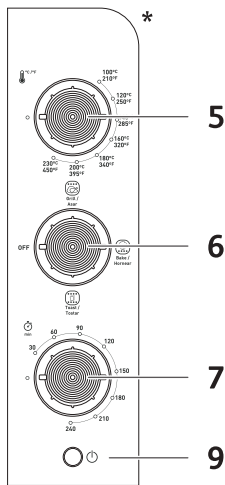
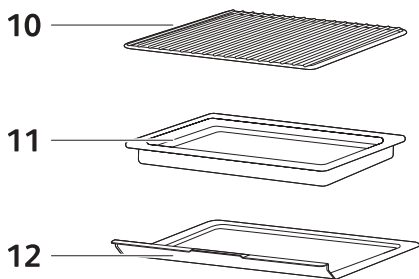
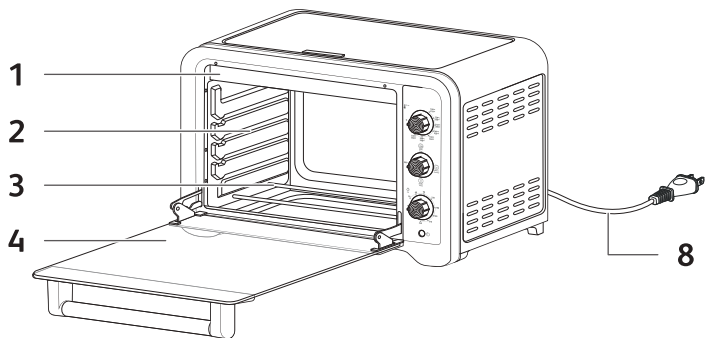

***EN: WARNING: WHEN USING THE "STAY-ON" FUNCTION, USER MUST BE ON-SITE** since the product keeps working until unplugging the power cord.

***ES: ADVERTENCIA: AL UTILIZAR LA FUNCIÓN DE "PERMANENCIA", EL USUARIO DEBE ESTAR EN EL LUGAR** ya que el producto sigue funcionando hasta que se desconecte el cable de alimentación.

DESCRIPTION

- | | | | |
|---|--------------------------|----|-----------------------|
| 1 | Top heating element | 7 | Timer knob |
| 2 | Aluminium walls | 8 | Power cord |
| 3 | Bottom heating element | 9 | Power indicator light |
| 4 | Double-glass door | 10 | Grill rack |
| 5 | Temperature control knob | 11 | Baking tray |
| 6 | Functions knob | 12 | Crumb tray |

IMPORTANT PRECAUTIONS



IMPORTANT PRECAUTIONS:

- **Make sure you read all the instructions.**
- This appliance is not intended to function using an external time-switch or a separate remote control system.
- **⚠ This appliance is not intended for use by persons (including children) with reduced physical, sensory or mental capabilities, or lack of experience and knowledge, unless they have been given supervision or instruction concerning use of the appliance by a person responsible for their safety.**

- ⚠ Children must be supervised to ensure that they do not play with the appliance.
- Bearing in mind all the different standards in force, if this appliance is to be used in a country other than that where it was purchased, make sure it is checked by an approved service centre.
- Do not move the appliance while it is in use.
- This appliance is not designed to be built in to other furnishing units. Place your oven on a flat, stable, heat-resistant work surface or on a kitchen unit which can tolerate a temperature of at least 90°C.
- Make sure that air can flow freely all around your appliance.
- We advise you when using for the first time, to operate your oven empty (without grill).

- Allow a distance of at least 2 cm between food articles and the upper heating element. It is quite normal if you notice a slight amount of smoke or some smells of newness when you use your appliance for the first time, and this completely normal occurrence will quickly disappear.
- Check that the mains voltage corresponds correctly to that indicated on the appliance (alternating current only).
- Do not use the appliance if:
 - it has a faulty or damaged power cord,
 - the appliance has been dropped and shows visible signs of damage or of malfunction.
- In each of these cases, to avoid any risks to your safety the appliance should be sent to the nearest approved service centre.

- To ensure safety, if the power cord is damaged, it must be replaced by either the manufacturer, its approved service centre or similarly qualified persons.
- Make sure that your electricity supply is sufficient for an appliance of this power.
- Do not allow the power cord to hang down or come into contact with the hot parts of the oven.
- Do not unplug the appliance by pulling on the power cord.
- Unplug the appliance when you need to carry out major cleaning to the appliance or in the event of a thunderstorm.
- Only use an extension lead which is in good condition, with an earthed plug, and with a conducting cord which is at least as thick as the cord supplied with the product.

- Unplug the appliance or active Oven timer function if you want to leave it unattended.
- In order to avoid the risk of electric shocks; do not dip the cord, the plug or the appliance itself into water or any other liquid.
- Do not place the appliance close to any heat source or near to any electrical elements. Do not stand the appliance on top of any other appliance.
-  **Surfaces may become hot during use. This electrical appliance functions at high temperatures which may cause burns. Do not touch the metal parts or the glass of your oven.**
-  **The door and the external surface may become hot when the appliance is in use.**

- Use the handles and the buttons; use oven gloves if necessary.
- Be careful when opening and closing the door of your oven: any violent shock or excessive stress caused by variations in temperature may break the glass parts.
- These parts are made of toughened glass in order to avoid any risk of spray and thus avoid danger to the user.
- Never place any plates on the glass of your oven when it is open.
- Should any parts of the product catch fire never try to extinguish the fire with water. Unplug the appliance and do not open
- the door. Smother the flames with a damp cloth.
- Do not store any inflammable products close to or underneath the furniture unit where the appliance is located.

- Do not operate the appliance under a wall unit, shelving, or close to inflammable materials such as blinds, curtains, drapes...
- Do not use the appliance as a heat source.
- Do not leave the appliance unattended whilst in use.
- Never place paper, cardboard, or plastic in the appliance and never put anything on top of it (utensils, grill, objects, hot dishes after cooking...).
- Do not remove the control buttons from the control panel when it is being cleaned.
- Do not put any aluminium foil under the appliance to protect the work surface, nor between the heating elements, nor in contact with the inside walls or the elements, because you run the risk of seriously damaging the oven or the work surface.

- Never insert anything into the ventilation ducts and do not obstruct them.
- Do not use any powerful cleaning products (notably soda based strippers), nor brillo pads, nor scourers.
- Do not use cleaning products which are specifically designed for metals.
- For your safety, never dismantle the appliance yourself; contact an Approved Service Centre.
- As this appliance is for household use only, it is not intended for use in the following applications and the guarantee will not apply for:
 - staff kitchen areas in shops, offices and other working environments;
 - farm houses;
 - by clients in hotels, motels and other residential type environments;
 - bed and breakfast type environments.

KEEP THESE INSTRUCTIONS IN A SAFE PLACE

EN



Environment protection first!

- ① Your appliance contains valuable materials which can be recovered or recycled.
- ➔ Leave it at a local civic waste collection point.

This product has been designed for domestic use only. Any commercial use, inappropriate use or failure to comply with the instructions, the manufacturer accepts no responsibility and the guarantee will not apply.

DESCRIPCIÓN

- | | | | |
|---|---------------------------------|----|-----------------------------|
| 1 | Elemento térmico superior | 7 | Botón del timer |
| 2 | Paredes de aluminio | 8 | Cable de alimentación |
| 3 | Elemento térmico inferior | 9 | Luz indicadora de encendido |
| 4 | Puerta de doble vidrio | 10 | Rejilla del grill |
| 5 | Botón de control de temperatura | 11 | Charola de asado |
| 6 | Botón de funciones | 12 | Charola de migajas |

PRECAUCIONES IMPORTANTES

PRECAUCIONES IMPORTANTES:

- **Tome el tiempo necesario y lea todas las instrucciones.**
- Este aparato no debe ponerse en funcionamiento mediante un temporizador externo ni por medio de un control remoto.
- **⚠ Este aparato no está diseñado para ser utilizado por personas (incluidos los niños) cuyas capacidades físicas, sensoriales o mentales sean reducidas, o por personas con falta de experiencia o de conocimientos, salvo si éstas están vigiladas por una persona**

responsable de su seguridad o han recibido instrucciones relativas al uso del aparato.

-  Se recomienda mantener vigilado a los niños para asegurarse de que no jueguen con el aparato.
- Teniendo en cuenta la diversidad de normativas vigentes, si este aparato se utiliza en un país diferente al país de compra, hágalo revisar por un servicio técnico autorizado.
- No mueva el aparato mientras esté en funcionamiento.
- Este aparato no está diseñado para ser empotrado. Coloque el horno en una superficie de trabajo estable o encima de un mueble de cocina que pueda soportar temperaturas de al menos 90°C.
- Deje un espacio alrededor del aparato para que pueda circular el aire libremente.

- Le aconsejamos que la primera vez que ponga en funcionamiento el horno lo haga sin nada en su interior (sin rejilla, charola de migajas o charola de asado).
- Mantenga una distancia de al menos 2 cm entre los alimentos y la resistencia superior.
- Cuando se utiliza el aparato por primera vez, es normal que se desprenda algo de humo u olor a nuevo. Esto es totalmente normal y desaparece rápidamente.
- Compruebe que la tensión de la red eléctrica corresponde a la indicada en el aparato (solamente corriente alterna).
- No utilice el aparato si:
 - presenta un cable defectuoso o dañado,

- ha caído y presenta deterioros visibles o anomalías de funcionamiento.
- En cualquiera de estos casos, debe llevar el aparato al centro de servicio autorizado más próximo con el fin de evitar cualquier peligro.
- En caso de que el cable de alimentación esté dañado, deberá ser cambiado en un centro de servicio autorizado con el fin de evitar cualquier peligro.
- Asegúrese de que la instalación eléctrica es suficiente para alimentar un aparato con esta potencia.
- No deje que el cable quede suspendido o en contacto con superficies calientes del horno.
- No desconecte el aparato tirando del cable.
- Cuando quiera hacer una limpieza a fondo o en caso de tormenta es necesario desconectar el aparato.

- Si utiliza una extensión eléctrica, asegúrese se encuentra en buen estado, con un cable de sección igual o superior al cable que incluye el producto.
- Desconecte el artefacto o active el timer de la función de horno si desea dejarlo desatendido.
- Para evitar descargas eléctricas, no sumerja el cable eléctrico, la toma de corriente o el aparato en agua o en cualquier otro líquido.
- No coloque el aparato cerca de una fuente de calor o cerca de otros aparatos eléctricos. No lo coloque encima de otros aparatos eléctricos.
-  **Las superficies del aparato pueden calentarse durante el uso. Este aparato eléctrico funciona a temperaturas elevadas que podrían ocasionar quemaduras. No toque las partes metálicas ni el cristal.**

-  La temperatura de la puerta y de la superficie exterior pueden ser elevadas cuando el aparato está funcionando.
- **Utilice las asas y las perillas. Utilice eventualmente guantes.**
- Cuando manipule la puerta del horno, hágalo con precaución: cualquier golpe frontal o choque térmico excesivo puede producir la rotura de los cristales. Éstos son de cristal templado para evitar cualquier riesgo de proyección, y cualquier peligro para el usuario.
- No coloque nunca platos encima del cristal del horno cuando esté abierto.
- En caso de prenderse fuego en alguna parte del aparato no intente jamás apagarlo con agua. Primero desconecte el aparato y no abra la puerta. Apague las llamas con un trapo húmedo.

- No deje productos inflamables cerca o encima del mueble en el que se encuentra el aparato.
- No ponga en funcionamiento el aparato en un mueble de pared, una estantería o cerca de materiales inflamables como persianas, cortinas, etc.
- No utilice el aparato como fuente de calor.
- No coloque jamás papel, cartón o plástico dentro del aparato ni ponga nada encima (utensilios, grill, objetos, platos calientes después de la cocción...).
- No desmonte las perillas del panel de control cuando los esté limpiando.
- No coloque papel de aluminio para proteger la superficie de trabajo, ni entre los elementos que generan calor, ni en contacto con las paredes interiores o resistencias

ya que se podría dañar gravemente el funcionamiento del horno o la superficie de trabajo.

- No introduzca nada en las aperturas de ventilación ni las obstruya.
- No utilice productos de limpieza agresivos (como corrosivos a base de sosa), estropajos, o cepillos abrasivos. No utilice ningún producto de limpieza específico para metales.
- Para su seguridad, no desmonte el aparato usted mismo; diríjase a un centro de servicio autorizado.
- Este aparato se ha diseñado únicamente para uso doméstico. El aparato no se ha diseñado para ser utilizado en los siguientes casos, que no están cubiertos por la garantía:
 - En zonas de cocina reservadas al personal en tiendas, oficinas y demás entornos profesionales.

- En granjas.
- Por los clientes de hoteles, moteles y demás entornos de tipo residencial.
- En entornos de tipo casas de turismo rural.

ES

GUARDE ESTAS RECOMENDACIONES EN UN LUGAR SEGURO



¡ ¡ Participe en la conservación del medio ambiente !!

- ① Su electrodoméstico contiene materiales recuperables y/o reciclables.
- ➔ Entréguelo al final de su vida útil, en un Centro de Recolección específico donde será tratado de forma adecuada.

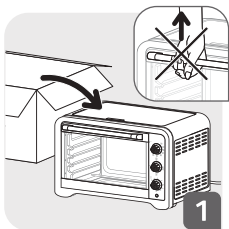
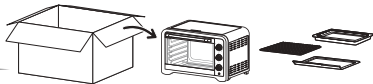
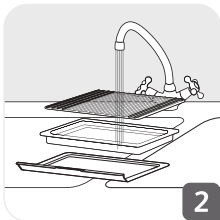
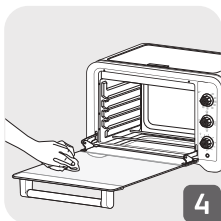
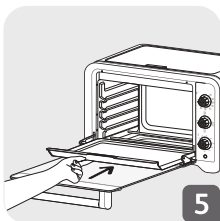
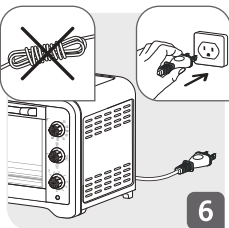
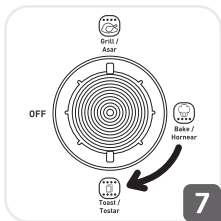
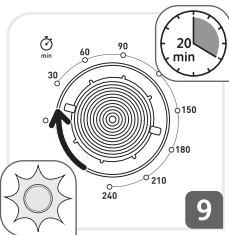
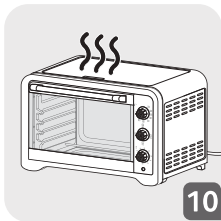
1**1****2****3****4****5****6****7****8****9****10****11****12**

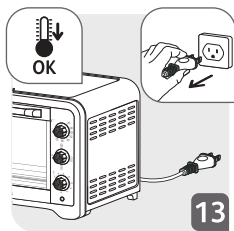

2

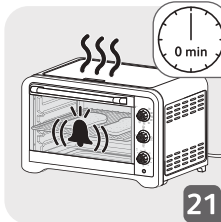
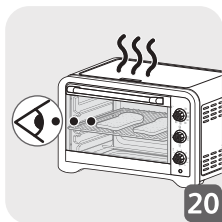
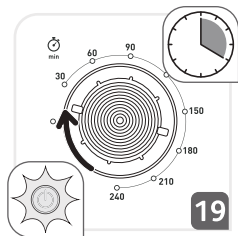
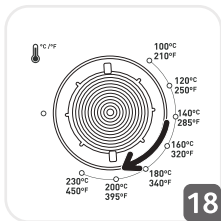
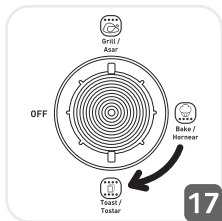
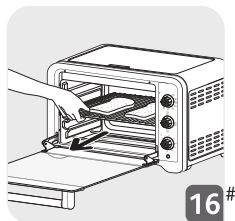
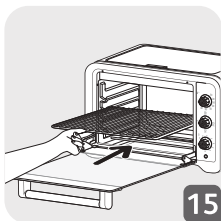
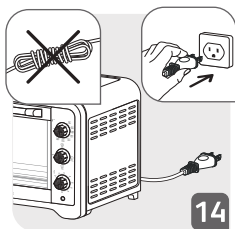

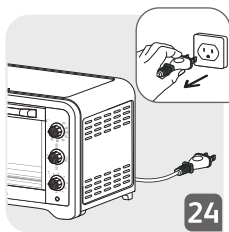
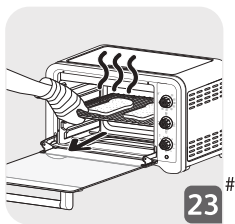

EN: The dish is not supplied with the appliance.

ES: El plato no está incluido con el producto.

3

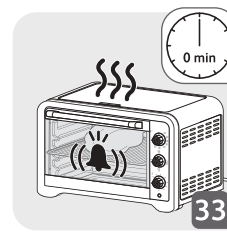
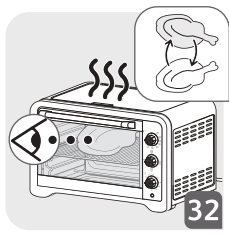
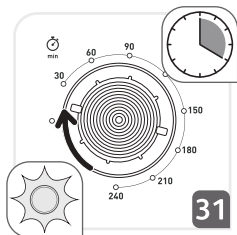
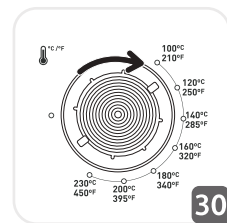
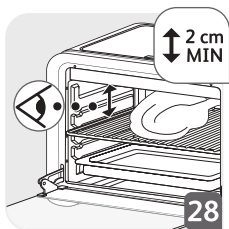
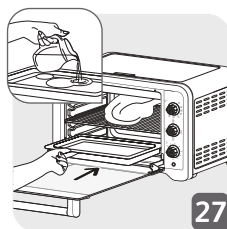
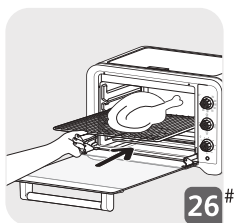
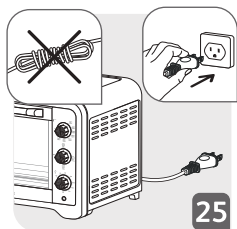

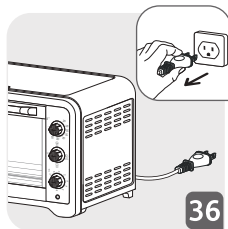
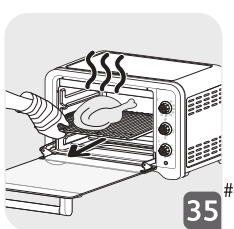

4

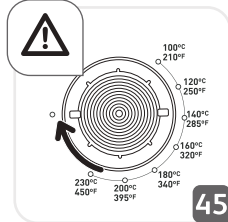
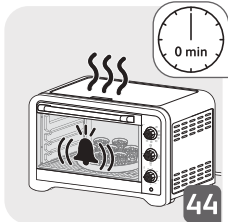
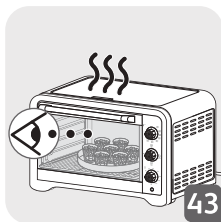
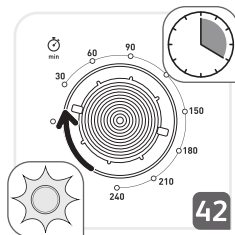
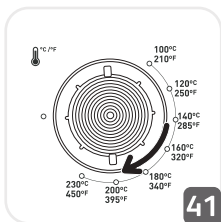
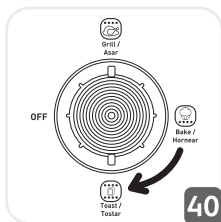
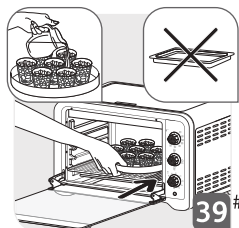
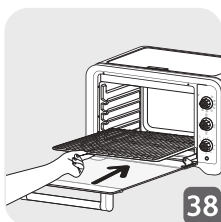
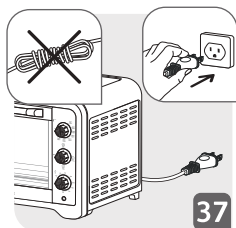

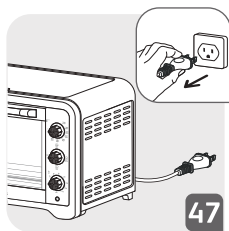
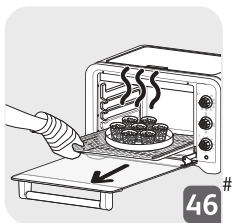





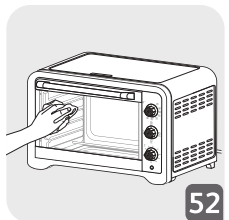
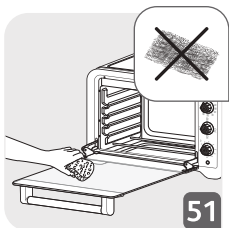
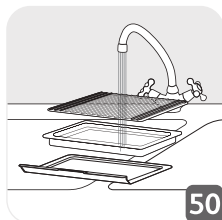
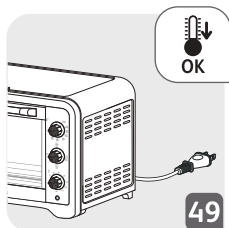
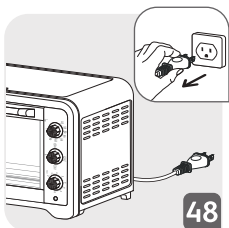

















































































EN: The dish is not supplied with the appliance.
ES: El plato no está incluido con el producto.

5





6

								
								min
	x4					10 mins	230°C 450°F	20
	1.5 kg 3.3 lb					10 mins	230°C 450°F	60
	5.4 kg 12 lb					10 mins	180°C 340°F	200
	750 g 1.7 lb					10 mins	230°C 450°F	30
	1 kg 2.2 lb					---	230°C 450°F	80
	x4					---	230°C 450°F	20 +10
	x8					---	230°C 450°F	15 +5
	350 gr 0.8 lb					10 mins	230°C 450°F	15
	x12					10 mins	230°C 450°F	45
	650gr 1.4 lb					10 mins	230°C 450°F	20
						---	230°C 450°F	30
						10 mins	200°C 395°F	45
						10 mins	200°C 395°F	20
						---	140°C 285°F	45
						10 mins	230°C 450°F	50
						10 mins	230°C 450°F	30

depending on model / según el modelo

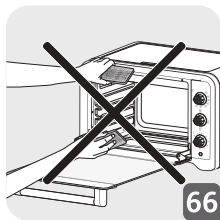
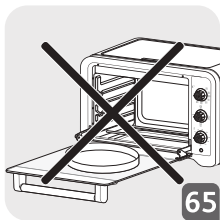
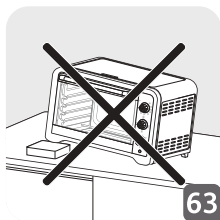
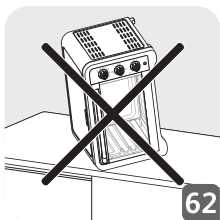
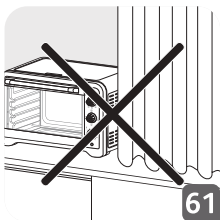
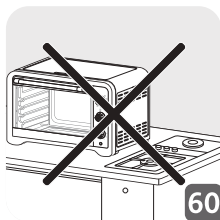
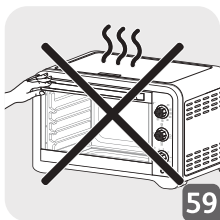
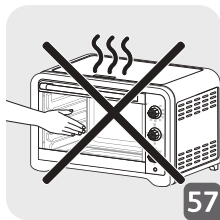
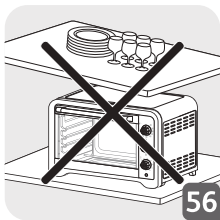
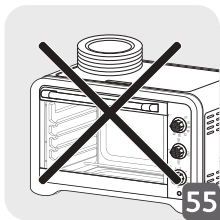

INSTRUCTIVO DE OPERACIÓN

Le invitamos a leer cuidadosamente este instructivo antes de usar su aparato, en él encontrará las características e instrucciones para el mejor aprovechamiento del mismo.

Verifique que el voltaje de su instalación sea igual al de su aparato lo cual se indica en este instructivo.

HORNO TOSTADOR
Modelo : OF533855
CMMF : 1510001927



Importador:
Groupe SEB México S.A. de C.V.
Calle Boulevard Miguel de Cervantes Saavedra No. 169 Piso 9,
Col. Ampliación Granada C.P. 11520 Ciudad de México
www.t-fal.com.mx

Características eléctricas :
127 V~ 60 Hz 1600 W

Home & Cook y Centro de Servicio
Av. San Fernando 649, local 27 A
Col. Peña Pobre, C.P. 14060
Alcaldía Tlalpan, Ciudad de México. México

Servicio al Consumidor :
55 52 83 93 54

EN p. 3 – 12

ES p. 13 – 22