

# AIR FRYER

[www.tefal.com](http://www.tefal.com)

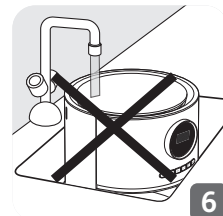

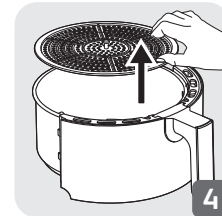
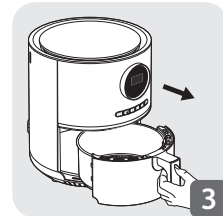
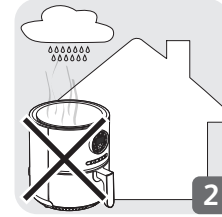
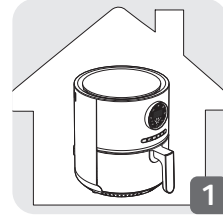
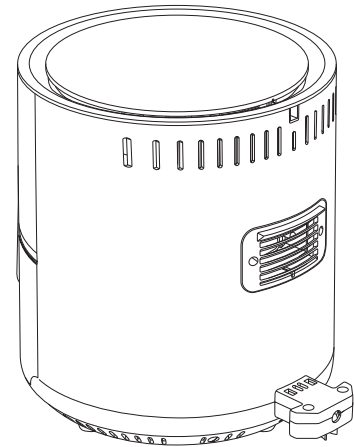

MAX 700 g

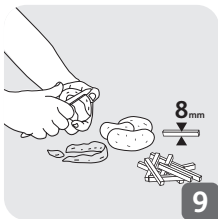

9



10



11

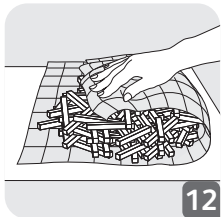

12



13



14

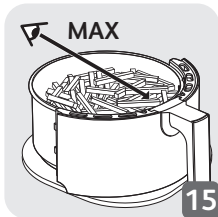

15



16



MAX 700 g



17

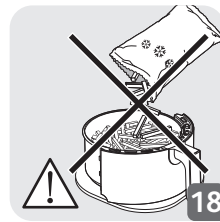

18

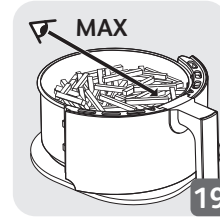

19



20

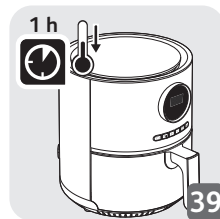
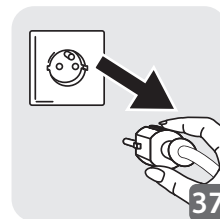
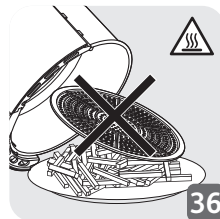
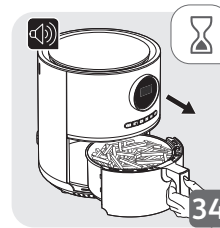
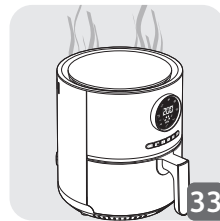
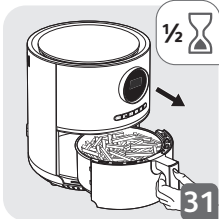
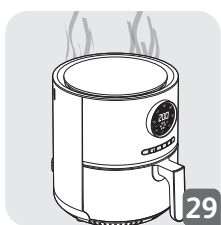
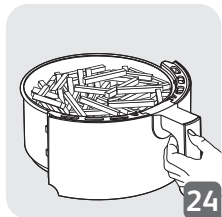
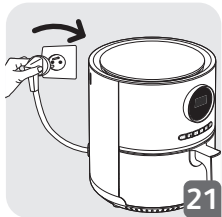

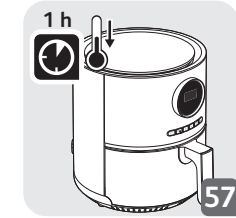
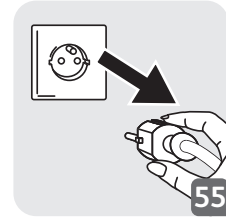
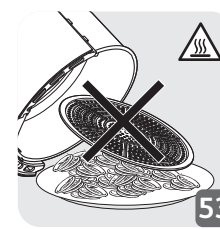
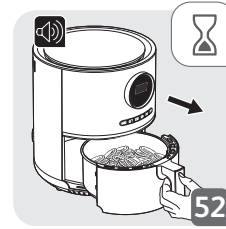
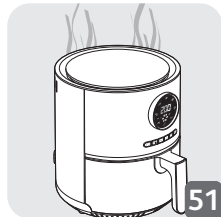
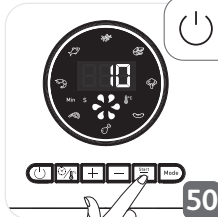
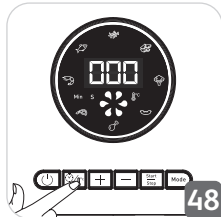
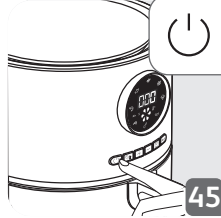
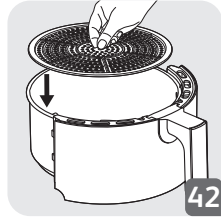
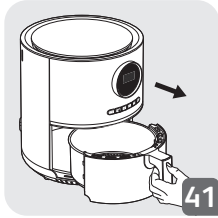
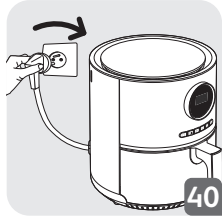

	300 g - 700 g	15 - 25 min	180°C	✓		
	300 g - 700 g	22 - 32 min	180°C	✓		
	300 g - 600 g	15 min	180°C	✓		
	3-5 pieces	16 - 20 min	200°C			
	1000 g	60 min	180°C			
	100 g - 600 g	20 - 22 min	200°C	✓		
	2 - 3 pieces	12 - 14 min	200°C	✓		
	350 g	10 min	180°C			
	12 pieces	8 min	180°C			

