

EN

ZH

VI

MS

TH

KO



Ultrablend Boost

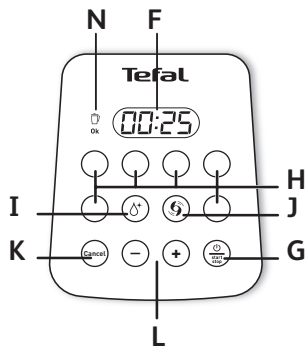
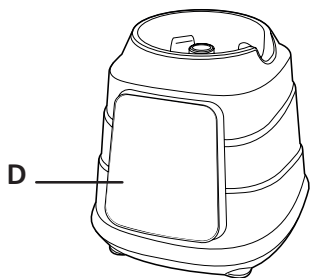
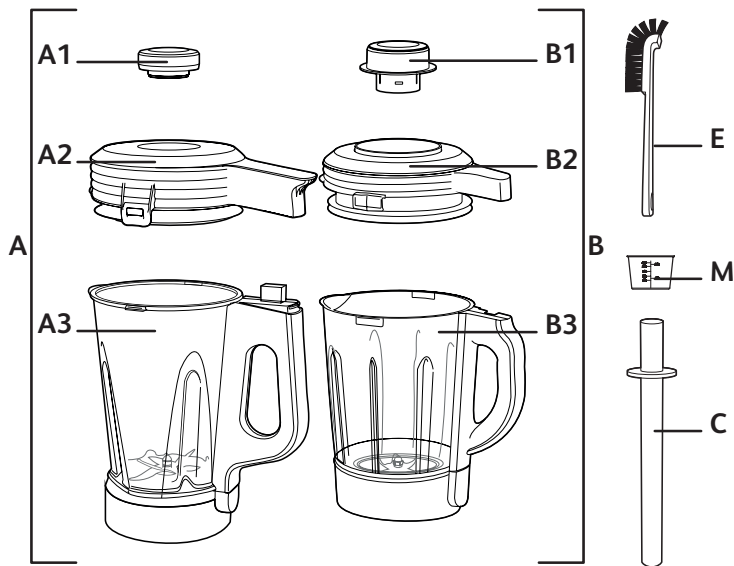

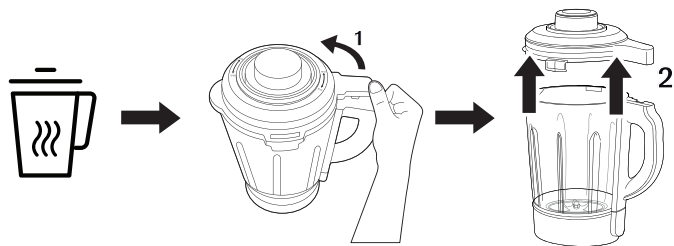
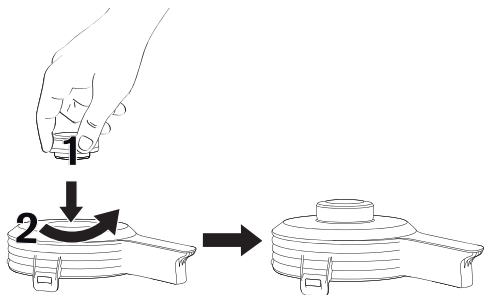



CAUTION: The safety precautions are part of the appliance. Read them carefully before using your new appliance for the first time. Keep them in a place where you can find and refer to them later on.

The appliance will only start if the jug is correctly positioned on the motor unit (D) and the lid locked on the jug.

DESCRIPTION

A Lid cap	F Screen
Lid	G Start/Stop button
Plastic Tritan Jug for cold preparation	H Control display
B Lid cap	I Clean button
Lid	J Blend button
Glass Jug for hot preparation	K Cancel button
C Pusher	L Setting button
D Motor unit	M Measuring cup
E Brush	N Jar indicator

BEFORE USING YOUR APPLIANCE FOR THE FIRST TIME

- Before using your appliance for the first time, rinse the parts that come into contact with food (jug, lid and measuring cup) with soapy water

CAUTION : Do not immerse the appliance in water (neither the motor unit nor the jug base). Never put the motor unit (D) under running water. Clean with a damp cloth and dry it carefully.

The blades are extremely sharp and not removable.

- Make sure all the packaging has been removed before operating the appliance.

USING YOUR APPLIANCE

- Put the appliance on a flat, stable, heat-resistant surface away from sources of heat or water splashes.
- Position the jug (A or B) correctly on the motor unit Fig. 1 and 2.
- After removing a bowl from the base, wait at least 6 seconds before repositioning another bowl.



OK **GLASS JAR FOR HOT PREPARATION:**

- Add the ingredients into the jug without exceeding the maximum level indicated:
 - 1400 ml max for hot preparation

Automatic function:

How to use :

- Lock the lid on the jug and place the lid cap in position on the lid. The appliance only starts up once the jug and lid are correctly in place.
- When you plug in the appliance and switch it on, it will make a beep, and the screen will light up.
- The appliance will be in standby mode. At this stage, you can select a program by pressing the corresponding button. Button light flashes and the recipe time information will be displayed.
- Press the start/stop button. Then the appliance starts to work automatically.
- At the end of the recipe, the blender stops automatically. The appliance beeps 3 times.
- You can also stop the blending during the cycle:
 - press the «Start/stop» button to pause the program (up to 5 minutes, after which the unit returns to the home screen)
 - press the «cancel» button to stop the program and return to the home screen.
- For hot programs and Heat function, if the power shuts off during cooking, within 3 minutes if the power is turned back on, the appliance will restart automatically.
 - If the appliance is left unused for 3 minutes, the screen light will go off and only the start/stop button will remain on.

CAUTION :

- Do not shake the motor unit or the jug when the blender is in use.

CAUTION: After running one program, especially if a long processing time, let the blender rest for minimum 5 minutes before operating it again.





For hot programs, please note that the time indicated does not take into account the pre-heating time needed which may vary according to the initial temperature and quantity of your ingredients (between 5 and 15 minutes).

Press the start/stop button. The recipe cooking time countdown will start.

During the program, if you open the lid of your blender, your appliance stop automatically thanks to the lid safety.

CAUTION : We recommend not to add ingredients while blending hot preparations. (risk of splashing). Do not remove the lid cap (B1) from the lid (B2) during hot preparations. It can reach high temperature and cause burns.

Hot programs : Soup, Compote, Coulis, Hot sauce, Multigrain milk.



Hot Programs	Recipes	Step by step	Time
 Soup	600g pumpkin, 120g potato, 80g onion, 600 ml water.	Select Soup program Press Start/Stop button	30 min
 Hot sauce	500 ml milk, 45g butter, 45g plain flour, nutmeg (1 pinch)	Select Hot sauce program Press Start/Stop button	15 min
 Coulis	100ml water, 60ml lemon juice, 100g sugar, 250g blueberries, 250g strawberries.	Select Coulis program Press Start/Stop button	15 min
 Compote	700g golden delicious apple, 100 ml water.	Select Compote program Press Start/Stop button	15 min
 Multigrain milk	100g whole blanched almonds, 1L water	Select Multigrain milk program Press Start/Stop button	25 min

Manual functions:

The manual functions can be used in addition to program mode.

-  **Clean** : allows you to clean your appliance with 150 ml water and 1 drop washing up liquid. Press Clean button. The duration is 30 seconds.

The longest working time can not be more than 3 minutes.

-  **Blend** : allows you to freely control the way you want to blend. Press the blend button, the screen indicates « P » corresponding to the pulse function but you can choose the blending speed from 1 to 9 by pressing the setting +/- buttons (L). « H » is the maximum speed. Then press start/stop button. You can set up the working time by pressing the setting +/- button (L) between 5 seconds and 3 minutes. The remaining time appears on the screen. Wait for the blender to stop automatically. The appliance beeps 3 times.
-  **Heat** : allows you to freely control the way you want to heat. Press the heat button, the screen indicates « 75 » but you can choose the heating temperature from 40° up to 100° by pressing the setting +/- buttons (L). You can set up the working time by pressing the setting +/- buttons (L) between 5 minutes and 90 minutes. Press start/stop button. The remaining time appears on the screen. Wait for the heating to stop automatically. The appliance beeps 3 times at the end of the program. You can also stop the heating during the cycle by pressing the start/stop button or the cancel button.



ok **PLASTIC TRITAN JAR FOR COLD PREPARATION**

- Add the ingredients into the jug without exceeding the maximum level indicated:
 -  1750 ml max for cold jar

Automatic functions

How to use :





- Lock the lid on the jug and place the lid cap in position on the lid. The appliance only starts up once the jug and lid are correctly in place.
- When you plug in the appliance and switch it on, it will make a beep, and the screen will light up.
- The appliance will be in standby mode. At this stage, you can select a program by pressing the corresponding button. The button light flashes and the recipe time information will be displayed.
 - Before each auto program, you can use vacuum function by pressing 'vacuum button', duration: 1min10s
 - When you use the vacuum function, ensure the lid cap is screwed on tight.

- Press the start/stop button and the appliance will start. At the end of the recipe, the blender stops automatically. The appliance beeps 3 times.
- If using the blender function, once the program is complete, press the middle of the lid cap to open the lid.
- You can also stop the blending during the cycle:
 - press the «Start/stop» button to pause the program (up to 5 minutes, after which the unit returns to the home screen)
 - press the «cancel» button to stop the program and return to the home screen
- You can use the pusher to help the recipes (when no vacuum function)
 - Don't use this jar for hot preparation.
 - Don't immerse the lid in water

To add ingredients while blending for cold preparation only, remove the lid cap (A) from the lid (B) and add the ingredients through the feeder hole. Beware of the risk of spatter.

CAUTION : Do not remove the lid cap (A) from the lid during vacuum

Cold programs : Ice crush, Green smoothie, Milk shake, Ice cream, Peanut butter



Cold Programs	Recipes	Step by step	Time
 Green smoothie	240g peeled apple Granny Smith (2 apples), 60g celery stick (without leaf), 200g cucumber, 20g kale leaf, 80g lime juice, 400g water, 60g Agave Syrup, 20g of spinach leaves	Select green smoothie program Press Start/Stop button	1min 10s
 Ice cream	450g of frozen strawberry + 240ml of milk + 130g of sugar	Select ice cream program Press Start/Stop button	1min 10s
 Peanut butter	400g of unsalted peanuts + 75g of slivered almonds + 125g of pecan nuts	Select peanut butter program Press Start/Stop button	2min 15s
 Ice crush	8 x Ice cube 30x30x40 mm	Select ice crush program Press Start/Stop button	1min
 Milk shake	250g vanilla ice cream + 1 banana (100g) + 250ml milk	Select milkshake program Press Start/Stop button	1min

Manual functions

The manual functions can be used in addition to program mode.

-  **Clean** : allows you to clean your appliance with 150 ml water and 1 drop washing up liquid. Press Clean button. The duration is 30 seconds.

The longest working time cannot be more than 3 minutes.

-  **Blend** : allows you to freely control the way you want to blend. Press the blend button, the screen indicates « P » corresponding to the pulse function but you can choose the blending speed from 1 to 9 by pressing the setting +/- button (L). «H» is the maximum speed. Then press start/stop button. You can set up the working time by pressing the setting +/- button (L) between 5 seconds and 3 minutes. The remaining time appears on the screen. Wait for the blender to stop automatically. The appliance beeps 3 times.
-  **Vacuum** : Before using the vacuum function, lock the lid cap by rotating it in such a way that the arrow on the lid cap is aligned with the «air out» pictogram . Begin vacuum process. After 1min10s, you will be able to select an automatic program (compatible with smoothie and milkshake programs). At the end of the program, press the vacuum button in the middle of the lid cap and remove the cap to remove the lid and pour your preparation.

OTHER FUNCTIONS

- Press the «Start/stop» button to pause the program. You can pause your appliance up to 5 minutes, after which the appliance returns to the home screen.
- If you keep pressing the «Start / Stop» button for 3 seconds, the appliance beeps 3 times before going into «Stand by» mode. No more button lights are visible except the «Start / Stop» button.

Overload protection

- The appliance is equipped with overload protection. This prevents the motor from being damaged by overloading.
- If the appliance switches off during operation, proceed as follows :
 - Switch the appliance off using the start/stop button, unplug and leave it to cool down for approximately 15-20 minutes.
 - Reconnect the appliance to the power supply and resume blending.

- **Cancel** : You can stop the blending during the cycle by pressing the «cancel» logo. The appliance stops and returns to the home screen.

CLEANING

- Clean the jug immediately after use.
- For easy cleaning, you can use the Clean program :
 - Put 150ml of water and 1 drop of washing up liquid in the jug. Press the Clean button.
- An excess of washing up liquid creates more foam and consequently can lead to overflowing. Finish cleaning the jug with the aid of a sponge.
- Rinse the inside of the jug and the lid under running water.
- If your appliance needs deep cleaning, you can use a mixture of warm water and baking soda. Let it soaked for few hours to help get it clean.
- Use a damp cloth to clean the motor unit (D). Dry it carefully.
- The detachable parts (lid, lid cap, measuring cup) can be cleaned with a sponge and hot soapy water. You can also use the brush to clean the inside of the jug.

Caution:

- Ensure that no food or liquid is left in the jug; the jug is not meant for storing food in the refrigerator or freezer.
- To clean the outside of the motor unit and the walls of the jug, use a damp cloth.
- Do not immerse the appliance in water (neither the motor unit nor the jug base). Never put the motor unit (D) under running water.
- The jug, lid cap must not go in the dishwasher.

WHAT TO DO IF YOUR APPLIANCE DOES NOT WORK ?

Problems	Causes	Solutions
Appliance does not work	The plug is not connected.	Connect the appliance to a socket with the same voltage as indicated on the rating plate of the appliance.
	The blender jug is not positioned correctly on the motor unit or the jug and lid are correctly in place and are not locked onto the motor unit.	Check that the blender jug and the lid are positioned properly on the motor unit as explained in the instructions.
	Appliance, keypad or program not responding	Unplug the appliance, wait for 1 minute and plug in again.
	In case of overheating	Switch the appliance off using the start/stop button, unplug and leave it to cool down for approx. 15-20 minutes.
	Overflowing	Reduce the quantity of the ingredients processed.
The appliance stopped while in use	Overload or overheating	Switch the appliance off using the start/stop button, unplug and leave it to cool down for approx. 15-20 minutes. Reconnect the appliance to the power supply and resume blending.
Excessive vibrations	The product is not placed on a flat surface.	Place the appliance on a flat surface.
	Volume of ingredients is too high.	Reduce the quantity of ingredients processed.
Leak or overflow from the lid	Volume of ingredients is too high.	Reduce the quantity of ingredients processed.
	The lid is not correctly positioned.	Place the lid correctly on the blender jug.

Problems	Causes	Solutions
Leak from the bottom of the blender jug	Deterioration of the watertightness of the appliance.	Caution : the blades are not removable. Contact the consumer service, see contact information in the warranty leaflet.
The blades do not turn easily	Pieces of food too large or too hard.	Reduce the size or quantity of ingredients processed.
	The blended liquid is too hot and distorted the silicon gasket.	Contact the consumer service, see contact information in the warranty leaflet.
Cooking problem	The food is not cooked enough or / The food is overcooked	Use manual function to adapt time of use and heating temperature
	Food sticks to the bottom	Use manual function to adapt time of use and heating temperature. And see cleaning instructions
I do not have access to good recipes	The appropriate jar is not used	Verifying that the appropriate jar is used
	The overflow sensor placed in the hot jar lid is not clean	Clean all the part of the hot jar lid

If your appliance is still not running properly, please contact the customer service department for your country.

重要安全事項

注意： 使用本裝置時請遵照安全指示。首次使用本裝置前請仔細閱讀安全措施說明，並妥為保存，留待日後參考。

榨汁杯必須正確裝在摩打組(D)上，且榨汁杯蓋已鎖好，本裝置才會啟動。

描述

- | | |
|--------------------------|-----------------------------|
| A 頂蓋
杯蓋
冷食材Tritan杯 | G 「Start/Stop」
(開始/停止) 鍵 |
| B 頂蓋
杯蓋
熱食材玻璃杯 | H 控制螢幕 |
| C 攪拌棒 | I 清潔鍵 |
| D 摩打組 | J 攪拌鍵 |
| E 清潔刷 | K 「Cancel」(取消) 鍵 |
| F 螢幕 | L 設定鍵 |
| | M 量杯 |
| | N 攪拌杯底指示燈 |

初次使用本裝置前

- 初次使用本裝置前，請用肥皂水清潔所有與食物接觸的部分（攪拌杯、杯蓋、量杯）。

注意： 請勿將本裝置浸在水裏（不論是摩打組或攪拌杯座）。切勿用水沖洗摩打組（D）。小心用濕布清潔然後抹乾。

刀片異常鋒利，且無法拆除。

- 使用本裝置前請確定已移除所有包裝物。

- 請將本裝置放在平坦、穩定、隔熱的表面，並遠離熱源及避免被水濺到。
- 將攪拌杯(A或B)正確裝在摩打組上。圖1及圖2。
- 從底座拿走杯後，請等待至少 6 秒，才放上另一個杯。



OK 熱食材玻璃杯：

- 攪拌杯內所放材料不宜超過指定的最高位：
-  處理熱食材時不可超過1400毫升

全自動功能：

使用方法：

- 鎖好攪拌杯蓋，並裝好頂蓋在杯蓋上。攪拌杯及杯蓋必須裝好，本裝置才會啟動。
- 插上電源並開動後，裝置會發出一聲「嗶」並亮起螢幕。
- 裝置將處於待機模式。此時可按相應的程式按鈕選擇程式。鍵上的燈會閃爍；螢幕顯示程式的時間資訊。
- 按「Start/Stop」（開始/停止）鍵。裝置開始自動運作。
- 程式結束時，攪拌器會自動停止。裝置會響3次。
- 運作期間也可以用以下方法停止：
- 按「Start/Stop」（開始/停止）鍵暫停程式（最長5分鐘，此後裝置會回到主畫面）
- 按「Cancel」（取消）鍵停止程式並回到主畫面。
- 熱食材程式及加熱功能中，如電力在烹調期間中斷，只要在3分鐘內重新開動裝置，裝置會自動重啟。
- 如裝置閑置3分鐘，螢幕燈會熄滅，僅「Start/Stop」（開關制）亮起。

注意：

- 當攪拌器正在運作時，請勿搖動摩打組或榨汁杯。

注意：使用一項程式後（特別是經過長時間使用），須冷卻最少5分鐘後方可再用。

使用熱程式時，請注意螢幕所顯示的時間不包括預熱時間；預熱時間會因應起始溫度及所放材料量而不同（5至15分鐘）。

按「Start/Stop」（開始/停止）鍵。開始倒數食譜的烹調時間。

本裝置的杯蓋有安全設計，如在程式進行期間打開攪拌杯蓋，攪拌器

會自動停止。



注意：攪拌熱食材期間，不建議添加材料。（以防材料濺出）。攪拌熱食材期間，請勿將杯蓋(B2)上的頂蓋(B1)拆出。熱程式的高溫可造成燙傷。

熱食材程式：湯、米糊/水果薈、果泥、熱醬汁、五穀奶。

熱食材程式	食譜	步驟	時間
 湯	南瓜600克、薯仔120克、洋蔥80克、水600毫升。	選擇湯程式 按「Start/Stop」 (開始/停止) 鍵	30分鐘
 熱醬汁	奶500毫升、牛油45克、中筋麪粉45克、豆蔻粉(1撮)	選擇熱醬汁程式 按「Start/Stop」 (開始/停止) 鍵	15分鐘
 果泥	水100毫升、檸檬汁60毫升、糖100克、藍莓250克、士多啤梨250克。	選擇果泥程式 按「Start/Stop」 (開始/停止) 鍵	15分鐘
 米糊/ 水果薈	金冠蘋果 (Gold delicious apple) 700克、水100毫升。	選擇水果薈程式 按「Start/Stop」 (開始/停止) 鍵	15分鐘
 五穀奶	去皮杏仁100克、水1公升	選擇五穀奶 按「Start/Stop」 (開始/停止) 鍵	25分鐘

手動功能：

除內置程式外，另有各種手動功能。

-  **清潔：**使用本功能時，加入150毫升水及1滴洗潔精。按「清潔」鍵。功能為時30秒。
最長運作時間不可超過3分鐘。
-  **攪拌：**隨意選擇攪拌方式。按攪拌鍵，螢幕顯示「P」，然而此時可按設定鍵+/- (L) 選擇1至9的攪拌速度。「H」為最高轉速。然後按「Start/Stop」(開始/停止) 鍵。按設定鍵+/- (L) 可調校運作時間，可選時間由5秒至3分鐘。螢幕會顯示餘下時間。等待攪拌機自動停止。裝置會響3次。
-  **加熱：**可隨意選擇加熱方式。按加熱鍵，螢幕顯示「75」，然而此時可按設定鍵+/- (L) 選擇40°至100°的加熱溫度。按設定鍵+/- (L) 可調校運作時間，可選時間為5至90分鐘。按「Start/Stop」(開始/停止) 鍵。螢幕會顯示餘下時間。等

待加熱自動停止。裝置會在程式結束時發出3聲「嗶」。另外亦可在程式進行中按「Start/Stop」（開始/停止）鍵或「Cancel」（取消）鍵停止加熱。



ok 冷材料Tritan杯

• 攪拌杯內所放材料不宜超過指定的最高位：

–  冷材料膠杯的最大容量為1750毫升

全自動功能：

使用方法：

- 蓋好攪拌杯蓋，將其鎖緊，然後將頂蓋裝好。攪拌杯及杯蓋必須裝好，本裝置才會啟動。
- 插上裝置電源並按開啟裝置時，裝置會發出一聲「嗶」，螢幕會亮起。
- 裝置將處於待機模式。此時可按相應的程式按鈕選擇程式。鍵上的燈會閃爍；螢幕顯示程式的時間資訊。
- 啟動每項自動程式前都可按「真空鍵」，使用抽真空功能，時間為1分鐘10秒
- 使用抽真空功能時，須確定頂蓋已經擰緊。
- 按「Start/Stop」（開始/停止）鍵啟動裝置。食譜結束時，攪拌機會自動停止。裝置會響3次。
- 使用攪拌功能時，當程式結束後，可按頂蓋的中間打開攪拌杯蓋。
- 運作期間也可以用以下方法停止：
- 按「Start/Stop」（開始/停止）鍵可暫停程式（最長5分鐘，此後裝置會回到主畫面）。
- 按「Cancel」（取消）鍵可停止程式並回到主畫面。
- 可使用攪拌棒輔助攪拌（不適合抽真空功能之中）
- 本攪拌杯不適合處理熱食材。
- 杯蓋不可浸水。

攪拌冷食材期間（熱食材攪拌不適用），如要添加材料，可拆出杯蓋(B)上的頂蓋(A)，透過頂孔放入材料。小心材料濺出。





注意: 抽真空期間請勿打開頂蓋(A)

冷材料程式：刨冰、蔬果汁、奶昔、雪糕、花生醬

冷食材程式	食譜	步驟	時間
 蔬果汁	去皮 翠玉蘋果(Granny Smith)240克(2個)、西芹莖60克(去葉)、青瓜200克、羽衣甘藍20克、青檸汁80克、水400克、龍舌蘭糖漿60克、菠菜葉20克	選擇蔬果汁程式 按「Start/Stop」 (開始/停止)鍵	1分鐘 10秒
 雪糕	冷凍士多啤梨450克+奶240毫升+糖130克	選擇雪糕程式 按「Start/Stop」 (開始/停止)鍵	1分鐘 10秒
 花生醬	無鹽花生400克+杏仁碎75克+山核桃125克	選擇花生醬程式 按「Start/Stop」 (開始/停止)鍵	2分鐘 15秒
 刨冰	30x30x40毫米冰塊8塊	選擇刨冰程式 按「Start/Stop」 (開始/停止)鍵	1分鐘
 奶昔	雲呢拿味雪糕250克+香蕉1條(100克)+奶250毫升	選擇奶昔程式 按「Start/Stop」 (開始/停止)鍵	1分鐘

手動功能

除內置程式外，另有各種手動功能。

-  **清潔**：使用本功能時，加入150毫升水及1滴洗潔精。按「清潔」鍵。功能為時30秒。
最長運作時間為3分鐘。
-  **攪拌**：隨意選擇攪拌方式。按攪拌鍵，螢幕顯示「P」，然而此時可按設定鍵+/- (L) 選擇1至9的攪拌速度。「H」為最高轉速。然後按「Start/Stop」(開始/停止)鍵。按設定鍵+/- (L) 可調校運作時間，可選時間為5秒至3分鐘。螢幕會顯示餘下時間。等待攪拌機自動停止。裝置會響3次。
-  **抽真空**：使用抽真空功能前，須轉動頂蓋，直至頂蓋的箭嘴對準「抽真空」圖示，表示頂蓋已鎖緊。開始抽真空功能。1分鐘10秒後可選擇所需自動程式(蔬果汁及奶昔程式適用)。程式結束後，按頂蓋上的抽真空鍵，移除蓋帽，將杯蓋拆出，然後倒入材料。

其他功能

- 按「Start/Stop」（開始/停止）鍵暫停程式。暫停時間最長5分鐘，此後裝置會回到主畫面。
- 如按住「Start/Stop」（開始/停止）鍵3秒鐘，裝置會響3次，然後進入「待機」模式。除「Start/Stop」（開始/停止）鍵外，所有其他鍵燈會熄滅。

超負荷保護

- 本裝置設有超負荷保護，避免摩打因為負荷過重已受損。
- 如果本裝置在操作中突然停止，請進行以下操作：
 - 按「Start/Stop」（開始/停止）鍵關閉裝置，拔除插頭，並冷卻約15至20分鐘。
 - 重新插上電源，繼續攪拌。
- **取消：**裝置運作期間可按「Cancel」（取消）鍵停止。裝置會停止並回到主畫面。

清潔

- 用完裝置立即清潔攪拌杯。
- 如要簡單清潔，可使用「清潔」程式：
 - 倒入水150毫升及一滴清潔液進攪拌杯。按「清潔」鍵。
- 過多洗潔精會產生大量泡沫，使攪拌杯滿瀉。清潔程式結束後，用海綿加以清理。
- 用清水沖洗攪拌杯及杯蓋內部。
- 如裝置需加以徹底清潔，可利用混合梳打粉的暖水。先浸泡數小時，可令清潔更容易。
- 用濕布清潔摩打組(D)。小心抹乾。
- 可拆出的部分（杯蓋、頂蓋、量杯）可用海綿加熱肥皂水清潔。攪拌杯內側也可以用毛刷清洗。

注意：

- 確定攪拌杯內無任何殘留材料或汁液。攪拌杯不適宜用來在雪櫃或冰格儲存食物。
- 摩打組及攪拌杯外側可以用濕布清潔。
- 請勿將本裝置浸在水裏（不論是摩打組或榨汁杯座）。切勿用水沖洗摩打組（D）。
- 切勿用洗碗機清洗攪拌杯、頂蓋。

裝置不能運作時應該如何？

問題	原因	解決方法
裝置無法運作	未插電源	所使用電源的電壓，須與本裝置功率牌上所指示的一致。
	攪拌杯並未正確裝在摩打組上，或攪拌杯及杯蓋雖然對位但未鎖好在摩打組上。	檢查攪拌杯及杯蓋是否已按說明所示正確裝在摩打組上。
	裝置、按鍵板或程式無反應	拔除電源，等1分鐘再插上。
	如出現過熱	按「Start/Stop」（開始/停止）鍵關閉裝置，拔除插頭，並冷卻約15至20分鐘。
	滿瀉	減少所處理的材料。
裝置在操作中突然停止	超載或過熱	按「Start/Stop」（開始/停止）鍵關閉裝置，拔除插頭，並冷卻約15至20分鐘。 重新插上電源，繼續攪拌。
震動過大	本產品所在的表面不平坦。	請將本裝置放在平坦表面。
	材料太滿。	減少所處理的材料。
材料從杯蓋漏出或滿瀉	材料太滿。	減少所處理的材料。
	杯蓋所放的位置不當	將杯蓋正確放在攪拌杯上。
材料從榨汁杯底漏出	裝置的防水性能減弱	注意：刀片並不能拆除。 請聯絡客戶服務部，聯絡資料載於保用證上。
刀片轉動不順	食物塊太大或太硬。	減少所處理材料的大小或分量。
	已攪拌的液體太熱，令矽膠圈變形。	請聯絡客戶服務部，聯絡資料載於保用證上。

問題	原因	解決方法
烹調問題	食材不夠熟或過熟	用手動功能調校操作時間及加熱溫度
	食材黏底	用手動功能調校操作時間及加熱溫度及參考說明書的清潔指引
無法選取食譜	並未使用合適的攪拌杯	檢查是否使用合適的攪拌杯
	熱攪拌杯蓋上的滿瀉感應器不潔	清潔熱攪拌杯杯蓋各個部分

如裝置仍然無法正常運作，請聯絡所在地區的客戶服務部。

CẢNH BÁO VỀ AN TOÀN

THẬN TRỌNG: Các biện pháp đề phòng là một phần của thiết bị. Hãy đọc kỹ chúng trước khi sử dụng thiết bị mới lần đầu tiên. Cất chúng ở nơi bạn có thể tìm thấy và tham khảo sau này. Thiết bị sẽ chỉ khởi động nếu bình được đặt chính xác lên bộ phận mô-tơ (D) nắp khóa trên bình.

MÔ TẢ

- | | |
|--|------------------------------|
| A Nắp đậy
Nắp
Hũ Tritan Nhựa cho hỗn hợp lạnh | E Chổi |
| B Nắp đậy
Nắp
Bình Thủy Tinh cho hỗn hợp nóng | F Lưới lọc |
| C Thiết bị đẩy | G Nút Bắt Đầu/Dừng |
| D Bộ phận mô-tơ | H Hiển thị điều khiển |
| | I Nút vệ sinh |
| | J Nút xay |
| | K Nút Hủy |
| | L Nút thiết lập |
| | M Gáo đo |
| | N Chỉ báo hũ |

TRƯỚC KHI SỬ DỤNG THIẾT BỊ LẦN ĐẦU

- Trước khi sử dụng thiết bị lần đầu, hãy rửa các bộ phận có tiếp xúc với thức ăn (bình, nắp và nắp đo) bằng nước xà phòng

THẬN TRỌNG: Không được nhúng thiết bị vào nước (bộ phận mô-tơ hoặc đế bình). Không được để cho bộ phận mô-tơ (D) dưới nước máy. Vệ sinh bằng vải ẩm và lau khô kỹ.

Các lưỡi dao rất sắc và không thể tháo rời.

- Đảm bảo tất cả bao bì đã được tháo ra trước khi vận hành thiết bị.

SỬ DỤNG THIẾT BỊ

- Đặt thiết bị lên một bề mặt bằng phẳng, ổn định, chống nhiệt cách xa các nguồn nhiệt hoặc nước bắn.
- Đặt bình (A hoặc B) chính xác lên bộ phận mô-tơ Hình 1 và 2.
- Sau khi tháo tô ra khỏi đế, chờ ít nhất 6 giây trước đặt đặt lại một tô khác.



OK

BÌNH THỦY TINH CHO HỖN HỢP NÓNG:

- Thêm các thành phần vào bình mà không vượt quá mức tối đa đã cho biết:
 -  Tối đa 1400 ml đối với hỗn hợp nóng

Chức năng tự động:

Cách sử dụng:

- Khóa nắp trên bình và đặt nắp đậy lên nắp. Thiết bị chỉ khởi động một khi đã đặt bình và nắp chính xác.
- Khi bạn cắm điện cho thiết bị và bật thiết bị, nó sẽ phát ra tiếng bíp, và màn hình sẽ sáng lên.
- Thiết bị sẽ chuyển sang chế độ chờ. Ở giai đoạn này, bạn có thể chọn một chương trình bằng cách nhấn nút tương ứng. Đèn nút sẽ nhấp nháy và thông tin về thời gian thực hiện công thức sẽ được hiển thị.
- Nhấn nút bắt đầu/dừng. Sau đó thiết bị sẽ tự động vận hành.
- Khi kết thúc công thức, máy xay sẽ tự động dừng. Thiết bị sẽ phát ra tiếng bíp 3 lần.
- Bạn cũng có thể dừng xay trong chu trình:
 - nhấn nút «Start/stop» để tạm dừng chương trình (lên đến 5 phút, sau đó thiết bị sẽ trở về màn hình chính)
 - nhấn nút «cancel» để dừng chương trình và trở lại màn hình chính.
- Đối với các chương trình nóng và chức năng Gia Nhiệt, nếu mất điện trong khi chế biến, trong vòng 3 phút nếu nguồn điện được bật lại, thiết bị sẽ tự khởi động lại.
 - Nếu không sử dụng thiết bị trong 3 phút, đèn màn hình sẽ tắt và chỉ có nút khởi động/dừng vẫn còn bật.

THẬN TRỌNG:

- Không được lắc bộ phận mô-tơ hoặc bình khi đang sử dụng máy xay.

THẬN TRỌNG: Sau khi chạy một chương trình, nhất là thời gian xử lý lâu, hãy để máy xay nghỉ trong tối thiểu 5 phút trước khi vận hành lại.





Đối với các chương trình nóng, vui lòng lưu ý rằng thời gian được cho biết không tính đến thời gian gia nhiệt trước cần thiết, thời gian này có thể khác nhau tùy theo nhiệt độ ban đầu và lượng thành phần (trong khoảng từ 5 đến 15 phút).

Nhấn nút bắt đầu/dừng. Quá trình đếm ngược thời gian chế biến công thức sẽ bắt đầu.

Trong chương trình, nếu bạn mở nắp của máy xay, thiết bị của bạn sẽ tự động dừng nhờ vào cơ chế đảm bảo an toàn của nắp.



THẬN TRỌNG: Chúng tôi khuyến cáo không nên thêm thành phần trong khi xay các hỗn hợp nóng. (nguy cơ bắn tóe). Không được tháo nắp đậy (B1) ra khỏi nắp (B2) khi sử dụng các hỗn hợp nóng. Nó có thể đạt đến nhiệt độ cao và gây bỏng.

Các chương trình nóng: Súp, Mứt, Sinh Tố Trái Cây, Sốt Nóng, Sữa Hỗn Hợp.

Các Chương Trình Nóng	Công thức	Từng bước	Thời gian
 Súp	600g bí ngô, 120g khoai tây, 80g hành, 600ml nước.	Chọn chương trình Súp Nhấn nút Bắt Đầu/Tạm Dừng	30 phút
 Sốt nóng	500 ml sữa, 45g bơ, 45g bột mì, nutmeg (1 nhúm)	Chọn chương trình Súp nóng Nhấn nút Bắt Đầu/Tạm Dừng	15 min
 Sinh tố trái cây	100ml nước, 60ml nước chanh, 100g đường, 250g việt quất, 250g dâu tây.	Chọn chương trình Sinh tố trái cây Nhấn nút Bắt Đầu/Tạm Dừng	15 min
 Mứt	700g táo vàng, 100 ml nước.	Chọn chương trình Mứt Nhấn nút Bắt Đầu/Tạm Dừng	15 min
 Sữa hỗn hợp	100g hạnh nhân chần nguyên hạt, 1L nước	Chọn chương trình Sữa hỗn hợp Nhấn nút Bắt Đầu/Tạm Dừng	25 min

Các chức năng thủ công:

Có thể sử dụng các chức năng thủ công ngoài chế độ chương trình.

-  **Vệ sinh:** cho phép bạn vệ sinh thiết bị bằng 150 ml nước và 1 giọt nước rửa chén. Nhấn nút Vệ sinh. Thời gian là 30 giây. **Thời gian vận hành lâu nhất không được quá 3 phút.**
-  **Xay:** cho phép tự do kiểm soát cách xay. Nhấn nút xay, màn hình hiện ra « P » tương ứng với chức năng nhồi nhưng bạn có thể chọn tốc độ xay từ 1 đến 9 bằng cách nhấn các nút thiết lập +/- (L). « H » là tốc độ tối đa. Sau đó nhấn nút bắt đầu/dừng. Bạn có thể cài đặt thời gian vận hành bằng cách nhấn nút thiết lập +/- (L) từ 5 giây đến 3 phút. Thời gian còn lại sẽ xuất hiện trên màn hình. Chờ đến khi máy xay tự động dừng. Thiết bị sẽ phát ra tiếng bíp 3 lần.
-  **Gia nhiệt:** cho phép tự do kiểm soát cách gia nhiệt. Nhấn nút gia nhiệt, màn hình hiển thị « 75 » nhưng bạn có thể chọn nhiệt độ gia nhiệt từ 40° lên đến 100° bằng cách nhấn nút thiết lập +/- (L). Bạn có thể cài đặt thời gian vận hành bằng cách nhấn nút thiết lập +/- (L) từ 5 phút đến 90 phút. Nhấn nút khởi động/dừng. Thời gian còn lại sẽ xuất hiện trên màn hình. Chờ đến khi quy trình gia nhiệt tự động dừng. Thiết bị phát ra tiếng bíp 3 lần khi kết thúc chương trình. Bạn cũng có thể dừng gia nhiệt trong chu kỳ bằng cách nhấn nút khởi động/dừng hoặc nút hủy.



ok HỮ TRITAN NHỰA ĐỐI VỚI HỖN HỢP LẠNH

- Thêm các thành phần vào bình mà không vượt quá mức tối đa đã cho biết:

–  Tối đa 1750 ml đối với hũ lạnh

Các chức năng tự động

Cách sử dụng:

- Khóa nắp trên bình và đặt nắp đậy lên nắp. Thiết bị chỉ khởi động một khi đã đặt bình và nắp chính xác.
- Khi bạn cắm điện cho thiết bị và bật thiết bị, nó sẽ phát ra tiếng bíp, và màn hình sẽ sáng lên.
- Thiết bị sẽ chuyển sang chế độ chờ. Ở giai đoạn này, bạn có thể chọn một chương trình bằng cách nhấn nút tương ứng. Đèn nút sẽ nhấp nháy và thông tin về thời gian thực hiện công thức sẽ được hiển thị.
- Trước mỗi chương trình tự động, bạn có thể sử dụng chức năng





chân không bằng cách nhấn 'nút chân không', thời lượng: 1 phút 10 giây

- Khi bạn sử dụng chức năng chân không, đảm bảo nắp đậy được vặn chặt.
- Nhấn nút khởi động/dừng và thiết bị sẽ khởi động. Khi kết thúc thời gian thực hiện công thức, máy xay sẽ tự động dừng. Thiết bị sẽ phát ra tiếng bíp 3 lần.
- Nếu sử dụng chức năng máy xay, một khi chương trình hoàn tất, nhấn vào giữa nắp đậy để mở nắp.
- Bạn cũng có thể dừng xay trong chu trình:
 - nhấn nút «Start/stop» để tạm dừng chương trình (lên đến 5 phút, sau đó thiết bị sẽ trở về màn hình chính)
 - nhấn nút «cancel» để dừng chương trình và trở lại màn hình chính
- Bạn có thể sử dụng bộ đẩy để giúp thực hiện công thức (khi không có chức năng chân không)
 - Dừng sử dụng hũ này cho hỗn hợp nóng.
 - Dừng nhúng nắp vào nước.

Để thêm thành phần trong khi xay chỉ đối với hỗn hợp lạnh, tháo nắp đậy (A) ra khỏi nắp (B) và thêm thành phần thông qua lỗ nạp. Cần thận với nguy cơ bắn tóe.





THẬN TRỌNG: Không được tháo nắp đậy (A) ra khỏi nắp trong khi sử dụng chức năng chân không

Các chương trình nguội: Xay nước đá, Xay sinh tố, Sữa hỗn hợp, Kem, Bơ đậu phộng

Các Chương Trình Lạnh	Công thức	Từng bước	Thời gian
 Sinh tố rau	240g táo đã gọt vỏ Granny Smith (2 quả táo), 60g cộng cần tây (không lá), 200g dưa leo, 20g lá cải xoăn, 80g nước chanh ta, 400g nước, 60g Xirô Agave, 20g lá cải bó xôi	Chọn chương trình sinh tố rau Nhấn nút Bắt Đầu/Tạm Dừng	1 phút 10 giây
 Kem	450g dây tây đông lạnh + 240ml sữa + 130g đường	Chọn chương trình kem Nhấn nút Bắt Đầu/Tạm Dừng	1 phút 10 giây
 Bơ đậu phộng	400g đậu phộng không thêm muối + 75g hạnh nhân trắng + 125g hạt hồ đào	Chọn chương trình bơ đậu phộng Nhấn nút Bắt Đầu/Tạm Dừng	2 phút 15 giây
 Đá xay	8 x viên đá 30x30x40 mm	Chọn chương trình đá xay Nhấn nút Bắt Đầu/Tạm Dừng	1min
 Sinh tố sữa	250g kem vanilla + 1 quả chuối (100g) + 250ml sữa	Chọn chương trình sinh tố sữa Nhấn nút Bắt Đầu/Tạm Dừng	1min

Các chức năng thủ công

Có thể sử dụng các chức năng thủ công ngoài chế độ chương trình.

-  **Vệ sinh:** cho phép bạn vệ sinh thiết bị bằng 150 ml nước và 1 giọt nước rửa chén. Nhấn nút Vệ sinh. Thời gian là 30 giây.
Thời gian vận hành lâu nhất không được quá 3 phút.
-  **Xay:** cho phép tự do kiểm soát cách xay. Nhấn nút xay, màn hình hiện ra « P » tương ứng với chức năng nhồi nhưng bạn có thể chọn tốc độ xay từ 1 đến 9 bằng cách nhấn các nút thiết lập +/- (L). «H» là tốc độ tối đa. Sau đó nhấn nút bắt đầu/dừng. Bạn có thể cài đặt thời gian vận hành bằng cách nhấn nút thiết lập +/- (L) từ 5 giây đến 3 phút. Thời gian còn lại sẽ xuất hiện trên màn hình. Chờ đến khi máy xay tự động dừng. Thiết bị sẽ phát ra tiếng bip 3 lần.
-  **Chân không :** Trước khi sử dụng chức năng chân không, hãy khóa nắp đậy bằng cách xoay nó sao cho mũi tên trên nắp đậy thẳng hàng với biểu tượng «air out» . Bắt đầu quy trình chân không. Sau 1 phút 10 giây, bạn sẽ có thể chọn một chương trình tự động (tương thích với các chương trình say sinh tố và sinh tố sữa). Khi kết thúc chương trình, nhấn nút chân không ở giữa chóp nắp và tháo

chóp ra để tháo nắp và rót chế phẩm.

CÁC CHỨC NĂNG KHÁC

- Nhấn nút «Start/stop» để tạm dừng chương trình. Bạn có thể tạm dừng thiết bị trong tối đa 5 phút, sau đó thiết bị sẽ trở về màn hình chính.
- Nếu bạn tiếp tục nhấn nút «Start / Stop» trong 3 giây, thiết bị phát ra tiếng bíp 3 lần trước khi chuyển sang chế độ «Stand by». Không nhìn thấy đèn nút nào nữa trừ nút «Start / Stop».

Chống quá tải

- Thiết bị được trang bị cơ chế chống quá tải Cơ chế này ngăn quá tải làm hỏng motor.
- Nếu thiết bị tắt trong quá trình vận hành, hãy tiến hành như sau:
 - Tắt thiết bị bằng nút khởi động/dừng, rút phích cắm và để nguội trong khoảng 15-20 phút.
 - Tái kết nối thiết bị với nguồn điện và tiếp tục xay.
- **Hủy** : Bạn có thể dừng xay trong chu kỳ bằng cách nhấn vào logo «cancel». Thiết bị sẽ dừng và trở về màn hình chính.

VỆ SINH

- Vệ sinh bình ngay sau khi sử dụng.
- Để dễ vệ sinh, bạn có thể sử dụng chương trình Vệ Sinh:
 - Cho 150ml nước và 1 giọt nước rửa chén vào bình. Nhấn nút Vệ Sinh.
- Nước rửa thừa tạo ra nhiều bọt hơn và có thể dẫn đến tràn. Hoàn thành vệ sinh bình bằng bọt xối.
- Rửa bên trong bình và nắp dưới nước máy.
- Nếu thiết bị cần vệ sinh kỹ, bạn có thể sử dụng một hỗn hợp nước ấm và natri bicarbonate. Nhúng thiết bị trong vài giờ để giúp vệ sinh sạch.
- Sử dụng một tấm vải ẩm để vệ sinh bộ phận motor (D). Lau khô cẩn thận.
- Các bộ phận có thể tháo rời (nắp, nắp đậy, nắp đo) có thể vệ sinh bằng bọt xối và nước xà phòng nóng. Bạn cũng có thể sử dụng bàn chải để vệ sinh bên trong bình.

Thận trọng:

- Đảm bảo rằng không còn lại thức ăn hay chất lỏng trong bình; bình không được thiết kế để bảo quản thực phẩm trong tủ lạnh hoặc tủ đông.
- Để vệ sinh bên ngoài bộ phận motor và thành bình, hãy sử dụng một tấm vải ẩm.
- Không được nhúng thiết bị vào nước (bộ phận motor hoặc đế bình). Không được để cho bộ phận motor (D) dưới nước máy.
- Không được rửa bình, nắp đậy bằng máy rửa chén.

PHẢI LÀM GÌ NẾU THIẾT BỊ KHÔNG HOẠT ĐỘNG?

Vấn đề	Nguyên nhân	Giải pháp
Thiết bị không hoạt động	Chưa kết nối phích cắm.	Kết nối thiết bị với một ổ cắm có cùng điện áp như cho biết trên bảng thông số của thiết bị.
	Chưa đặt chính xác bình máy xay lên bộ phận motor hoặc bình và nắp được đặt chính xác và chưa được khóa vào bộ phận motor.	Đảm bảo bình máy xay và nắp nằm đúng vị trí trên bộ phận motor như giải thích trong hướng dẫn.
	Thiết bị, phím bấm hoặc chương trình không đáp ứng	Rút phích cắm của thiết bị, chờ 1 phút và cắm lại.
	Trong trường hợp quá nhiệt	Tắt thiết bị bằng nút khởi động/dừng, rút phích cắm và để nguội trong khoảng 15-20 phút.
	Tràn	Giảm số lượng thành phần được xử lý.
Thiết bị dừng khi đang sử dụng	Quá tải hoặc quá nhiệt	Tắt thiết bị bằng nút khởi động/dừng, rút phích cắm và để nguội trong khoảng 15-20 phút. Tái kết nối thiết bị với nguồn điện và tiếp tục xay.
Rung quá mức	Sản phẩm không được đặt trên một bề mặt phẳng.	Hãy đặt thiết bị lên một bề mặt bằng phẳng.
	Thể tích của các thành phần quá lớn.	Giảm số lượng thành phần được xử lý.
Rò rỉ hoặc tràn từ nắp	Thể tích của các thành phần quá lớn.	Giảm số lượng thành phần được xử lý.
	Nắp không được lắp chính xác.	Đặt nắp chính xác lên bình máy xay.

Vấn đề	Nguyên nhân	Giải pháp
Rò rỉ từ đáy bình máy xay	Độ kín nước của thiết bị bị giảm.	Thận trọng: các lưỡi dao không thể tháo rời. Liên hệ với bộ phận dịch vụ khách hàng, xem thông tin liên hệ trong phiếu bảo hành.
Lưỡi dao không xoay dễ dàng	Các miếng thức ăn quá lớn hoặc quá cứng.	Giảm kích thước hoặc số lượng phần được xử lý.
	Chất lỏng đã xay quá nóng và làm biến dạng vòng đệm silicon.	Liên hệ với bộ phận dịch vụ khách hàng, xem thông tin liên hệ trong phiếu bảo hành.
Vấn đề khi chế biến	Thực phẩm không được nấu chín kỹ hoặc / Thực phẩm quá nhừ	Sử dụng chức năng thủ công để điều chỉnh thời gian sử dụng và nhiệt độ gia nhiệt
	Thức ăn dính vào đáy	Sử dụng chức năng thủ công để điều chỉnh thời gian sử dụng và nhiệt độ gia nhiệt. Và xem hướng dẫn vệ sinh
Tôi không tiếp cận được các công thức hay	Hũ thích hợp không được sử dụng	Đảm bảo sử dụng hũ thích hợp
	Cảm biến chống tràn lắp trong nắp hũ nóng không sạch	Vệ sinh tất cả các bộ phận của nắp hũ nóng

Nếu thiết bị của bạn vẫn hoạt động không chính xác, vui lòng liên hệ với phòng dịch vụ khách hàng phụ trách quốc gia của bạn.

AMARAN KESELAMATAN

AWAS: Amaran keselamatan adalah sebahagian daripada alat perkakas. Baca dengan teliti sebelum menggunakan alat perkakas baru anda dan rujuk kepadanya kemudian. Simpan di tempat yang mudah untuk dicari dan dirujuk pada masa hadapan. Alat perkakas hanya boleh digunakan jika jag diletakkan pada kedudukan yang betul pada unit motor (D) dan penutup dikunci pada jag.

MS

KETERANGAN

- | | |
|--|---|
| A Pelapik penutup
Penutup
Jag Tritan Plastik untuk penyediaan sejuk | E Berus
F Skrin
G Tekan butang mula/henti. |
| B Pelapik penutup
Penutup
Jag Tritan Plastik untuk penyediaan panas | H Paparan Kawalan
I Butang membersih
J Butang mengisar |
| C Penolak | K Butang Batal
L Butang Tetapan |
| D Unit motor | M Cawan sukat
N Penunjuk balang |

SEBELUM MENGGUNAKAN ALAT PERKAKAS ANDA BUAT PERTAMA KALI

- Sebelum menggunakan alat perkakas anda buat pertama kali, bilas bahagian yang bersentuhan dengan makanan (jag, penutup dan penutup sukat) dengan air bersabun

AWAS: Jangan rendam alat perkakas dalam air (unit motor atau asas jag). Jangan letak unit motor (D) pada air yang mengalir. Bersih menggunakan kain yang lembap dan kering dengan berhati-hati.

Bilah adalah amat tajam dan tidak boleh dicabut.

- Pastikan semua dalam pakej telah dikeluarkan sebelum memulakan alat perkakas.

MENGGUNAKAN ALAT PERKAKAS ANDA

- Letak alat perkakas pada permukaan yang rata, stabil, kebat-haba yang jauh daripada sumber panas atau percikan air.
- Letak jag pada kedudukan (A atau B) dengan betul pada unit motor Raj. 1 dan 2.
- Selepas mengeluarkan mangkuk daripada asas, tunggu sehingga 6 saat sebelum meletakkan mangkuk yang lain.



ok **JAG KACA UNTUK PENYEDIAAN YANG PANAS:**

- Tambah bahan-bahan ke dalam jag tanpa melebihi paras maksimum yang ditunjukkan:
–  1400 ml maksimum untuk penyediaan yang panas

Fungsi automatik:

Cara-cara penggunaan:

- Kunci penutup pada jag dan letak pada lapisan penutup dalam kedudukan atas penutup. Alat perkakas hanya boleh digunakan jika jag dan penutup diletak dengan betul.
- Apabila anda memasang kabel alat perkakas dan memulakannya, ia akan berbunyi beep, dan skrin akan menyala.
- Alat perkakas adalah dalam mod standby. Di peringkat ini, anda akan memilih program dengan menekan butang yang berkaitan. Lampu butang akan menyinar dan maklumat masa resipi akan dipaparkan.
- Tekan butang <Mula/henti>. Alat perkakas akan bermula secara automatik.
- Pada pengakhiran resipi, pengisar akan berhenti secara automatik. Alat perkakas akan berbunyi beep sebanyak 3 kali.
- Anda juga boleh menghentikan pengisaran ketika kitaran:
 - Tekan butang «Mula/henti» untuk menghentikan program buat seketika (sehingga 5 minit, selepas unit kembali pada skrin utama)
 - Tekan butang «batal» untuk menghentikan program dan kembali pada skrin utama.
- Untuk program fungsi panas dan hangat, jika kuasa berhenti ketika memasak, dalam masa 3 minit jika kuasa tidak kembali, alat perkakas akan bermula semula secara automatik.
- Jika alat perkakas ditinggalkan selama 3 minit, lampu skrin akan tutup

dan hanya butang mula/henti yang akan kekal menyala.

AWAS:

- Jangan goncang unit motor atau jag ketika pengisar sedang digunakan.

AWAS: Selepas menjalankan satu program, terutama sekali masa memproses adalah lama, biarkan pengisar berehat selama 5 minit sebelum menggunakannya sekali lagi.





Untuk program panas, sila ambil perhatian masa yang ditunjukkan tidak termasuk masa pra-pemanasan yang diperlukan mungkin lain mengikut suhu permulaan dan kuantiti bahan anda (antara 5 hingga 15 minit).

Tekan butang mula/henti. Masa memasak resipi akan bermula.

Ketika program dijalankan, jika anda membuka penutup pengisar anda, alat perkakas anda akan berhenti secara automatik.

AWAS: Kami sarankan agar tidak menambah bahan ketika menyediakan pengisaran panas. (Risiko percikan). Jangan buka lapik penutup (B1) daripada penutup (B2) ketika penyediaan panas. Ia boleh mencapai suhu yang tinggi dan menyebabkan kelecuman.

Program panas: Sup, Compote, Coulis, Sos panas, susu pelbagai bijirin.

Program panas:	Resipi	Langkah demi langkah	Masa
 Sup	600G labu, 120g kentang, 80g bawang, 600 ml air.	Pilih program Sup Tekan butang mula/henti.	30 min
 Sos panas	500 ml susu, 45g mentega, 45g tepung gandum, buah pala (secubit)	Pilih program sos Panas Tekan butang mula/henti.	15 min
 Coulis	100ml air, 60ml jus lemon, 100g gula, 250g beri biru, 250g strawberi	Pilih program Coulis Tekan butang Mula/Henti.	15 min
 Compote	700G epal merah, 100 ml air	Pilih program Compote Tekan butang mula/henti.	15 min
 Susu pelbagai bijirin	100G almond goreng, 1L air	Pilih program susu pelbagai Bijirin Tekan butang mula/henti.	25 min



Fungsi manual:

Fungsi manual boleh digunakan sebagai tambahan pada mod program.

-  **Bersih** : membolehkan anda membersihkan alat perkakas anda dengan 150 ml air dan 1 titis cecair pembersih. Tekan butang

Bersih. Masa adalah 30 saat.

Masa beroperasi paling lama tidak melebihi 3 minit.

-  **Mengisar** : Membolehkan anda untuk mengawal dengan bebas cara mengisar. Tekan butang kisar, skrin menunjukkan « P » merujuk pada fungsi nadi tetapi anda boleh pilih kelajuan mengisar dari 1 hingga 9 dengan menekan butang tetapan +/- (L). «H» adalah kelajuan maksimum. Tekan butang mula/henti. Anda boleh menetapkan masa beroperasi dengan menekan butang tetapan +/- (L) antara 5 saat dan 3 minit. Baki masa dipaparkan pada skrin. Tunggu sehingga pemanasan berhenti secara automatik. Alat perkakas akan berbunyi beep sebanyak 3 kali.
-  **Pemanasan** : Membolehkan anda untuk mengawal dengan bebas cara pemanasan. Tekan butang panas, skrin menunjukkan « 75 » tetapi anda boleh memilih suhu pemanasan daripada 40° sehingga 100° dengan menekan butang tetapan +/- (L). Anda boleh menetapkan masa beroperasi dengan menekan butang tetapan +/- (L) antara 5 saat dan 90 minit. Tekan butang mula/henti. Baki masa akan dipaparkan pada skrin. Tunggu sehingga pemanasan berhenti secara automatik. Alat perkakas anda berbunyi beep 3 kali pada pengakhiran program. Anda juga boleh menghentikan pemanasan ketika kitaran dengan menekan butang mula/henti atau butang batal.



ok **BALANG TRITAN PLASTIK UNTUK PENYEDIAAN SEJUK**

- Tambah bahan ke dalam jag tanpa melebihi paras maksimum yang ditunjukkan:
 -  1750 ml maksimum untuk balang sejuk

Fungsi automatik:

Bagaimana untuk guna:





- Kunci penutup pada jag dan letak pada lapisan penutup dalam kedudukan atas penutup. Alat perkakas hanya boleh digunakan jika jag dan penutup diletak dengan betul.
- Apabila anda memasang kabel alat perkakas dan memulakannya, ia akan berbunyi beep, dan skrin akan menyala.
- Alat perkakas akan masuk ke mod standby. Di peringkat ini, anda akan memilih program dengan menekan butang yang berkaitan. Lampu

- butang akan menyinar dan maklumat masa resipi akan dipaparkan.
- Sebelum setiap program auto, anda boleh menggunakan fungsi vakum dengan menekan 'butang vakum', tempoh: 1min10s
 - Apabila anda menggunakan fungsi vakum, pastikan pelapik penutup di pasang dengan ketat.
 - Tekan butang mula/henti dan alat perkakas akan bermula. Pada pengakhiran resipi, pengisar akan berhenti secara automatik. Alat perkakas akan berbunyi beep sebanyak 3 kali.
 - Jika menggunakan fungsi pengisar, apabila program lengkap, tekan bahagian tengah pelapik penutup untuk membuka penutup.
 - Anda juga boleh menghentikan pengisaran ketika kitaran:
 - Tekan butang «Mula/henti» untuk menghentikan program buat seketika (sehingga 5 minit, selepas unit kembali pada skrin utama)
 - Tekan butang «batal» untuk menghentikan program dan kembali pada skrin utama.
 - Anda boleh menggunakan penolak untuk membantu dalam resipi (apabila tiada fungsi vakum)
 - Jangan menggunakan balang untuk penyediaan panas.
 - Jangan rendam penutup dalam air

Untuk menambah bahan ketika mengisar hanya untuk penyediaan sejuk sahaja, buka pelapik penutup (A) daripada penutup (B) dan tambah bahan melalui lubang feeder. Berhati-hati dengan risiko percikan.

AWAS: Jangan buka lapik penutup (B1) daripada penutup ketika vakum

Program sejuk: Ais kisar, Smoothie hijau, Susu kocak, aiskrim, mentega kacang



Program sejuk:	Resipi	Langkah demi langkah	Masa
 Smoothie hijau	240g epal Granny Smith dibuang kulit (2 biji epal hijau), 60g batang seleri (tanpa daun), 200g timun, 20g daun kale, 80g jus limau, 400g air, 60g sirap Agave, 20g daun kangkung	Pilih program smoothie hijau Tekan butang Mula/Henti.	1Min 10s
 Aiskrim	450g strawberi beku + 240ml susu + 130g gula	Pilih program aiskrim Tekan butang Mula/Henti.	1Min 10s
 Mentega kacang	400G kacang tanpa garam + 75g badam dipotong + 125g kacang pecan	Pilih program mentega kacang Tekan butang Mula/Henti.	2min 15s
 Ais kisar	8 x kiub ais 30x30x40 mm	Pilih program ais kisar Tekan butang mula/henti.	1min
 Susu kocak	150g aiskrim vanila + 1 biji pisang (100g) + 250ml susu	Pilih program susu kocak Tekan butang mula/henti.	1min

Fungsi manual

Fungsi manual boleh digunakan sebagai tambahan pada mod program.

-  **Bersih** : membolehkan anda membersihkan alat perkakas anda dengan 150 ml air dan 1 titis cecair pembersih. Tekan butang Bersih. Masa adalah 30 saat.

Masa beroperasi paling lama tidak melebihi 3 minit.

-  **Mengisar** : Membolehkan anda untuk mengawal dengan bebas cara mengisar. Tekan butang kisar, skrin menunjukkan « P » merujuk pada fungsi nadi tetapi anda boleh pilih kelajuan mengisar dari 1 hingga 9 dengan menekan butang tetapan +/- (L). «H» adalah kelajuan maksimum. Tekan butang mula/henti. Anda boleh menetapkan masa beroperasi dengan menekan butang tetapan +/- (L) antara 5 saat dan 3 minit. Baki masa dipaparkan pada skrin. Tunggu sehingga pemanasa mula berhenti secara automatik. Alat perkakas akan berbunyi beep sebanyak 3 kali.
-  **Vakum**: Sebelum menggunakan fungsi vakum, kunci pelapik penutup dengan memutarinya agar anak panah pada pelapik

penutup selari dengan piktogram «udara keluar» . Mula proses vakum. Selepas 1min10s, anda boleh memilih program automatik (sesuai dengan program susu kocak dan smoothie). Pada pengakhiran program, tekan butang vakum di bahagian tengah tepi penutup dan keluarkan tepi untuk mengeluarkan penutup dan tuang persediaan anda.

FUNGSI-FUNGSI LAIN

- Tekan butang «Mula/Henti» untuk menghentikan program buat seketika. Anda boleh menghentikan alat perkakas anda buat seketika sehingga 5 minit, selepas itu alat perkakas akan kembali pada skrin utama.
- Jika anda terus menekan butang «Mula/Henti» selama 3 saat, alat perkakas akan berbunyi beep sebanyak 3 kali sebelum masuk mod «Standby» Tiada lampu butang menyala kecuali butang «Mula/Berhenti»

Perlindungan berlebihan

- Alat perkakas dilengkapi dengan perlindungan berlebihan. Ini mencegah motor daripada rosak atau terlebih panas.
- Jika alat perkakas ditutup ketika operasi, lakukan yang berikut:
 - Tutup alat perkakas menggunakan butang mula/henti, cabut plug dan biar sejuk selama 15-20 minit.
 - Sambung alat perkakas sekali lagi pada sumber kuasa dan teruskan mengisar.
- **Batal:** Anda boleh berhenti mengisar ketika kitaran dengan menekan logo «cancel». Alat perkakas berhenti dan kembali pada skrin utama.

MEMBERSIH

- Bersihkan jag dengan segera selepas digunakan.
- Untuk memudahkan pembersihan, anda boleh menggunakan program Bersih:
 - Letak 150ml air dan 1 titis cecair membasuh dalam jag. Tekan butang Bersih.
- Lebihan cecair membasuh akan menghasilkan lebih banyak buih dan boleh menyebabkan limpahan. Habiskan membersihkan jag dengan menggunakan span.
- Bilas bahagian dalam jag dan juga penutup bawah air yang mengalir.
- Jika alat perkakas anda memerlukan pembersihan mendalam, anda

boleh menggunakan gabungan air suam dan serbuk penaik. Rendam selama beberapa jam untuk membantu dalam pembersihan.

- Guna kain lembap untuk membersihkan unit motor (D). Keringkan dengan berhati-hati.
- Bahagian yang boleh dicabut (penutup, pelapik penutup, cawan sukat) boleh dibersihkan dengan span dan air bersabun yang panas. Anda juga boleh menggunakan berus untuk membersihkan bahagian dalam jag.

Awas:

- Pastikan tidak terdapat makanan atau cecair yang tertinggal dalam jag; jag bukan untuk menyimpan makanan dalam peti ais atau peti sejuk.
- Untuk membersihkan bahagian luar unit motor dan juga bahagian dinding jag, guna kain yang lembap.
- Jangan rendam alat perkakas dalam air (unit motor atau asas jag). Jangan letak unit motor (D) pada air yang mengalir.
- Jag, pelapik penutup tidak boleh dimasukkan dalam mesin pembasuh pinggan.

APA PERLU DILAKUKAN JIKA ALAT PERKAKAS ROSAK?

Masalah	Punca	Penyelesaian
Jika alat perkakas tidak berfungsi	Plag tidak disambungkan.	Sambungkan alat perkakas pada soket dengan voltan yang sama seperti ditunjukkan pada plat penarafan di alat perkakas.
	Jag pengisar tidak diletakkan dengan betul pada unit motor atau jag dan penutup tidak diletakkan dengan betul dan tidak berkunci pada unit motor.	Periksa jika jag pengisar dan juga penutup diletakkan dengan betul pada unit motor seperti yang dijelaskan dalam arahan.
	Alat perkakas, kekunci atau program tidak berfungsi	Cabut plag perkakas, tunggu sehingga 1 minit dan plag semula.
	Jika terlebih panas	Tutup alat perkakas menggunakan butang mula/henti, cabut plag dan biar sejuk selama 15-20 minit.
	Melimpah	Kurangkan kuantiti bahan yang diproses.
Alat perkakas berhenti apabila digunakan	Terlebih bahan atau terlebih panas	Tutup alat perkakas menggunakan butang mula/henti, cabut plag dan biar sejuk selama 15-20 minit. Sambung alat perkakas sekali lagi pada sumber kuasa dan teruskan mengisar.
Getaran yang berlebihan	Produk tidak diletakkan pada permukaan yang rata	Letak alat perkakas pada permukaan yang rata.
	Jumlah bahan terlalu tinggi.	Kurangkan kuantiti bahan yang diproses.

Masalah	Punca	Penyelesaian
Bocor atau melimpah daripada penutup.	Jumlah bahan terlalu tinggi.	Kurangkan kuantiti bahan yang diproses.
	Penutup tidak diletak dengan betul.	Letak penutup dengan betul pada jag pengisar.
Bocor daripada bahagian bawah jag pengisar.	Kedap air alat perkakas lusuh.	Awas: bilah tidak boleh dicabut. Hubungi perkhidmatan pelanggan, lihat maklumat pada risalah jaminan.
Bilah tidak pusing dengan mudah	Bahagian makanan yang terlalu besar atau keras.	Kurangkan saiz atau kuantiti bahan yang diproses.
	Cecair dikisar terlalu panas dan merosakkan gasket silikon.	Hubungi perkhidmatan pelanggan, lihat maklumat pada risalah jaminan.
Masalah memasak	Makanan tidak dimasak dengan baik / makanan terlalu masak	Guna fungsi manual untuk menyesuaikan masa penggunaan dan suhu pemanasan
	Makanan melekat di bahagian bawah	Guna fungsi manual untuk menyesuaikan masa penggunaan dan suhu pemanasan Dan liha arahan membersih
Saya tidak dapat mengakses resipi yang bagus	Balang yang bersesuaian tidak digunakan	Mengesahkan balang yang bersesuaian digunakan
	Sensor limpahan yang diletak pada penutup balang panas tidak bersih	Bersihkan semua bahagian penutup balang panas

Jika alat perkakas anda masih tidak berfungsi dengan betul, sila hubungi bahagian perkhidmatan pelanggan di negara anda.

คำเตือนความปลอดภัย

ข้อควรระวัง: คู่มือความปลอดภัยถือเป็นส่วนหนึ่งของเครื่องใช้ กรุณาอ่านรายละเอียดให้ครบถ้วนก่อนการใช้งานครั้งแรก เก็บคู่มือนี้ไว้ในจุดที่สะดวกและนำมาอ่านได้ในภายหลัง

เครื่องจะเริ่มทำงานเมื่อโถปั่นอยู่ในตำแหน่งที่ถูกต้องบนชุดมอเตอร์ (D) และฝาปิดล็อกอยู่บนโถปั่นแล้วเท่านั้น

TH

คำอธิบาย

- | | |
|--|--|
| A ฝาจุกปิด
ฝาปิด
โถปั่นพลาสติกไทรทันสำหรับการเตรียมอาหารแบบเย็น | E แปรง
F หน้าจอ
G ปุ่มเริ่ม/หยุด
H จอแสดงผลการควบคุม |
| B ฝาจุกปิด
ฝาปิด
โถปั่นแก้วสำหรับการเตรียมอาหารแบบร้อน | I ปุ่มทำความสะอาด
J ปุ่มปั่น
K ปุ่มยกเลิก
L ปุ่มตั้งค่า |
| C ส่วนกด | M ถ้วยตวง |
| D ชุดมอเตอร์ | N ไฟสัญญาณโถปั่น |

ก่อนการใช้งานเครื่องครั้งแรก

- ก่อนใช้งานเครื่องเป็นครั้งแรก ล้างชิ้นส่วนที่สัมผัสกับอาหาร (โถปั่น ฝาปิด และถ้วยตวง) ด้วยน้ำผสมน้ำยาล้างจาน

ข้อควรระวัง: ห้ามแช่ตัวเครื่องในน้ำ (ไม่ว่าจะเป็นชุดมอเตอร์หรือฐานรองโถปั่น) ห้ามล้างชุดมอเตอร์ (D) ผ่านน้ำไหล ทำความสะอาดด้วยผ้าชุบน้ำหมาด ๆ แล้วทำให้แห้งด้วยความระมัดระวัง

ใบมีดคมมากและไม่สามารถถอดได้

- ตรวจสอบให้แน่ใจว่าแกะห่อบรรจุภัณฑ์ทั้งหมด ก่อนใช้งานเครื่อง

การใช้งานเครื่อง

- วางเครื่องบนพื้นผิวที่เรียบ มั่นคง และทนความร้อน โดยให้ห่างจากแหล่งความร้อนหรือน้ำกระเด็น
- วางโถปั่น (A หรือ B) บนชุดมอเตอร์ให้เข้าที่อย่างถูกต้อง ตามภาพที่ 1 และ 2
- หลังจากถอดโถออกจากฐานแล้ว รออย่างน้อย 6 วินาทีก่อนใส่โถอีกใบเข้าแทนที่



ok โถปั่นแก้วสำหรับการเตรียมอาหารแบบร้อน

- ใส่ส่วนผสมลงในโถปั่น โดยไม่ให้เกิดระดับสูงสุดที่ระบุไว้
- $\frac{5}{8}$ สูงสุด 1,400 มล. สำหรับการเตรียมอาหารแบบร้อน

ฟังก์ชันอัตโนมัติ

วิธีใช้

- ล็อกฝาปิดบนโถปั่น จากนั้นใส่ฝาจุกปิดให้เข้าตำแหน่งบนฝาปิด เครื่องจะเริ่มทำงานเฉพาะเมื่อโถปั่นและฝาปิดเข้าที่อย่างถูกต้อง
- เมื่อเสียบปลั๊กเครื่องและเปิดสวิตช์ เครื่องจะส่งเสียงเตือนหนึ่งครั้งแล้วหน้าจอจะสว่างขึ้น
- เครื่องจะเข้าสู่โหมดสแตนด์บาย ในขั้นตอนนี้ สามารถเลือกโปรแกรมหดนมโดยกดปุ่มที่สอดคล้องกัน ไฟปุ่มจะกะพริบและข้อมูลเวลาในการทำอาหารจะแสดง
- กดปุ่มเริ่ม/หยุด จากนั้นเครื่องจะเริ่มทำงานโดยอัตโนมัติ
- เมื่อทำอาหารเสร็จแล้ว เครื่องบับจะหยุดทำงานโดยอัตโนมัติ เครื่องจะส่งเสียงเตือน 3 ครั้ง
- สามารถหยุดการทำงานของเครื่องบับในระหว่างรอบการทำงานได้
- กดปุ่ม "เริ่ม/หยุด" เพื่อหยุดโปรแกรมหดนมชั่วคราว (สูงสุด 5 นาทีหลังจากเครื่องกลับสู่หน้าจอหลัก)
- กดปุ่ม "ยกเลิก" เพื่อหยุดโปรแกรมหดนมและกลับสู่หน้าจอหลัก
- สำหรับโปรแกรมหดนมหรือฟังก์ชันอุ่นอาหาร หากปิดเครื่องระหว่างการทำอาหาร แต่เปิดใหม่ภายใน 3 นาที เครื่องจะเริ่มทำงานอีกครั้งโดยอัตโนมัติ
- หากไม่ได้ใช้เครื่องเป็นเวลา 3 นาที ไฟหน้าจอลดับ และมีเฉพาะปุ่มเริ่ม/หยุดที่ยังคงสว่างอยู่

ข้อควรระวัง:

- ห้ามเขย่าชุดมอเตอร์หรือโถปั่นขณะใช้งานเครื่องบับ

ข้อควรระวัง: หลังใช้งานมาแล้วหนึ่งโปรแกรมหดนม โดยเฉพาะกระบวนการที่ใช้เวลานาน ให้พักเครื่องเป็นเวลาอย่างน้อย 5 นาทีก่อนใช้งานอีก

ครึ่ง





สำหรับโปรแกรมอาหารร้อน โปรดทราบว่าเวลาที่ระบุไว้นั้นยังไม่รวมเวลาในการอุ่นล่วงหน้าที่ต้องใช้ ซึ่งอาจแตกต่างกันออกไปตามอุณหภูมิเริ่มต้นและปริมาณของส่วนผสม (ระหว่าง 5 ถึง 15 นาที)

กดปุ่มเริ่ม/หยุด การนับถอยหลังเวลาในการทำอาหารจะเริ่ม

ในระหว่างโปรแกรม หากเปิดฝาปิดเครื่องปั่น เครื่องจะหยุดโดยอัตโนมัติด้วยระบบรักษาความปลอดภัยฝาปิด

ข้อควรระวัง: ไม่แนะนำให้เติมส่วนผสมในขณะที่กำลังปั่นอาหารแบบร้อน (ความเสี่ยงจากการกระเด็น) ห้ามถอดฝาจากปิด (B1) ออกจากฝาปิด (B2) ระหว่างการเตรียมอาหารแบบร้อน เพราะอาจมีอุณหภูมิสูงและทำให้เกิดแผลไหม้

โปรแกรมอาหารแบบร้อน: ซุป น้ำเชื่อมผลไม้ ซอสผลไม้ ซอสพริก นมธัญพืชหลายชนิด

โปรแกรมอาหารแบบร้อน	สูตรอาหาร	ขั้นตอน	เวลา
 ซุป	ผักทอง 600 ก. มันฝรั่ง 120 ก. หอมหัวใหญ่ 80 ก. น้ำ 600 มล.	เลือกโปรแกรมซุป กดปุ่มเริ่ม/หยุด	30 นาที
 ซอสพริก	นม 500 มล. เนย 45 ก. แป้งสาลี 45 ก. จันทน์เทศ (1 หยิบมือ)	เลือกโปรแกรมซอสพริก กดปุ่มเริ่ม/หยุด	15 นาที
 ซอสผลไม้	น้ำ 100 มล. นำนมขาว 60 มล. น้ำตาลทรายขาว 100 ก. บลูเบอร์รี 250 ก. สตรอว์เบอร์รี 250 ก.	เลือกโปรแกรมซอสผลไม้ กดปุ่มเริ่ม/หยุด	15 นาที
 น้ำเชื่อมผลไม้ บด	แอปเปิ้ลสีทองแสนอร่อย 700 ก. น้ำ 100 มล.	เลือกโปรแกรมน้ำเชื่อมผลไม้ กดปุ่มเริ่ม/หยุด	15 นาที
 นมธัญพืช หลายชนิด	อัลมอนด์ลอกเปิ้ลอกทั้งเมล็ด 100 ก. น้ำ 1 ล.	เลือกโปรแกรมนมธัญพืช หลายชนิด กดปุ่มเริ่ม/หยุด	25 นาที



ฟังก์ชันแบบปรับเอง:

ฟังก์ชันแบบปรับเองสามารถใช้ได้เพิ่มเติมจากโหมดโปรแกรม

-  **การทำความสะอาด:** สามารถทำความสะอาดเครื่องด้วยน้ำเปล่า 150 มล. และน้ำยาล้างจาน 1 หยด กดปุ่มทำความสะอาด ระยะเวลา

30 วินาที

ใช้เวลาในการทำงานนานสูงสุดไม่เกิน 3 นาที

-  **การป้อน:** สามารถควบคุมวิธีการป้อนได้อย่างอิสระตามต้องการ กดปุ่มป้อน หน้าจอจะแสดง "P" ที่สอดคล้องกับฟังก์ชันหยุดเป็นจังหวะ แต่สามารถเลือกความเร็วในการป้อนจาก 1 ถึง 9 โดยกดปุ่มตั้งค่า +/- (L) "H" คือความเร็วสูงสุด จากนั้นกดปุ่มเริ่ม/หยุด สามารถตั้งเวลาการทำงานโดยกดปุ่มตั้งค่า +/- (L) ระหว่าง 5 วินาทีถึง 3 นาที เวลาที่เหลือจะปรากฏในหน้าจอ รอให้เครื่องป้อนหยุดโดยอัตโนมัติ เครื่องจะส่งเสียงเตือน 3 ครั้ง
-  **การทำความร้อน:** สามารถควบคุมวิธีการทำความร้อนได้อย่างอิสระตามต้องการ กดปุ่มทำความร้อน หน้าจอจะแสดง "75" แต่เลือกอุณหภูมิการทำความร้อนได้จาก 40 ถึง 100 องศาโดยกดปุ่มตั้งค่า +/- (L) สามารถตั้งเวลาการทำงานโดยกดปุ่มตั้งค่า +/- (L) ระหว่าง 5 นาทีถึง 90 นาที กดปุ่มเริ่ม/หยุด เวลาที่เหลือจะปรากฏในหน้าจอ รอให้การทำความร้อนหยุดโดยอัตโนมัติ เครื่องจะส่งเสียงเตือน 3 ครั้งเมื่อโปรแกรมสิ้นสุดการทำงาน นอกจากนี้ สามารถหยุดการทำความร้อนในระหว่างรอบการทำงาน โดยกดปุ่มเริ่ม/หยุดหรือปุ่มยกเลิก

 **ok โถปั่นพลาสติกไทรทันสำหรับการเตรียมอาหารแบบเย็น**

- ใส่ส่วนผสมลงในโถปั่น โดยไม่ให้เกินระดับสูงสุดที่ระบุไว้
-  สูงสุด 1,750 มล. สำหรับการเตรียมอาหารแบบเย็น

ฟังก์ชันอัตโนมัติ

วิธีใช้





- ล็อกฝาปิดบนโถปั่น จากนั้นใส่ฝาจุกปิดให้เข้าตำแหน่งบนฝาปิด เครื่องจะเริ่มทำงานเฉพาะเมื่อโถปั่นและฝาปิดเข้าที่อย่างถูกต้อง
- เมื่อเสียบปลั๊กเครื่องและเปิดสวิตช์ เครื่องจะส่งเสียงเตือนหนึ่งครั้งแล้วหน้าจอจะสว่างขึ้น
- เครื่องจะเข้าสู่โหมดสแตนด์บาย ในขั้นตอนนี้ สามารถเลือกโปรแกรมโดยกดปุ่มที่สอดคล้องกัน ไฟปุ่มจะกะพริบและข้อมูลเวลาในการทำอาหารจะปรากฏ
- ก่อนโปรแกรมอัตโนมัติแต่ละครั้ง สามารถใช้ฟังก์ชันสัญญาณภาคโดยกด "ปุ่มสัญญาณภาค" ระยะเวลา 1 นาที 10 วินาที
- เมื่อใช้ฟังก์ชันสัญญาณภาค ตรวจสอบให้แน่ใจว่าหมุนฝาจุกปิดจนแน่น
- กดปุ่มเริ่ม/หยุดและเครื่องจะเริ่มทำงาน เมื่อทำอาหารเสร็จ เครื่องป้อนจะหยุดทำงานโดยอัตโนมัติ เครื่องจะส่งเสียงเตือน 3 ครั้ง

- หากใช้ฟังก์ชันเครื่องปั่น เมื่อโปรแกรมทำงานเสร็จสิ้น กดตรงกลางของฝา จุกปิดเพื่อเปิดฝาจุกปิด
- สามารถหยุดการทำงานของเครื่องปั่นในระหว่างรอบการทำงานได้
- กดปุ่ม "เริ่ม/หยุด" เพื่อหยุดโปรแกรมชั่วคราว (สูงสุด 5 นาทีหลังจากเครื่อง กลับสู่หน้าจอหลัก)
- กดปุ่ม "ยกเลิก" เพื่อหยุดโปรแกรมและกลับสู่หน้าหลัก
- สามารถใช้ส่วนกดเพื่อช่วยในการทำอาหาร (เมื่อไม่มีฟังก์ชันสัญญาณภาค)
- ห้ามใช้โถปั่นนี้สำหรับการเตรียมอาหารแบบร้อน
- ห้ามแช่ฝาจุกปิดในน้ำ

ในการเติมส่วนผสมขณะที่ปั่นอาหารแบบเย็นเท่านั้น ให้ถอด ฝาจุกปิด (A) ออกจากฝาจุกปิด (B) และเติมส่วนผสมผ่านช่องป้อน โปรดระวัง ความเสี่ยงจากการกระเด็น

ข้อควรระวัง: ห้ามถอดฝาจุกปิด (A) ออกจากฝาจุกปิดระหว่างการทำ สัญญาณภาค

โปรแกรมอาหารแบบเย็น: บดน้ำแข็ง สมูทตี้สีเขียว มิลค์เชค ไอศกรีม เนย ถั่ว

โปรแกรมอาหารแบบเย็น	สูตรอาหาร	ขั้นตอน	เวลา
 สมูทตี้สีเขียว	แอปเปิ้ลเขียวแกรนนิสมีรปอก เปลือก (2 ลูก) 240 ก. ก้าน ขึ้นฉ่ายฝรั่ง 60 ก. (ไม่ใช้ใบ) แต่งกว่า 200 ก ใบคะน้า 20 ก. น้ามะนาว 80 ก. น้ำ 400 ก. น้ำเชื่อมอะกาเว 60 ก. ใบผักโขม 20 ก.	เลือกโปรแกรมสมูทตี้สีเขียว กดปุ่มเริ่ม/หยุด	1 นาที 10 วินาที
 ไอศกรีม	สตอร์วเบอร์รี่แช่แข็ง 450 ก. + นม 240 มล. + น้ำตาลทรายขาว 130 ก.	เลือกโปรแกรมไอศกรีม กดปุ่มเริ่ม/หยุด	1 นาที 10 วินาที
 เนยถั่ว	ถั่วลิสงที่ยังไม่โรยเกลือ 400 ก. + อัลมอนต์ที่ปอกเปลือกแล้ว 75 ก. + ถั่วพีแคน 125 ก.	เลือกโปรแกรมเนยถั่ว กดปุ่มเริ่ม/หยุด	2 นาที 15 วินาที
 น้ำแข็งบด	น้ำแข็งขนาด 30x30x40 มม. 8 ก้อน	เลือกโปรแกรมบดน้ำแข็ง กดปุ่มเริ่ม/หยุด	1 นาที
 มิลค์เชค	ไอศกรีมวานิลลา 250 ก. + กล้วย 1 ลูก (100 ก.) + นม 250 มล.	เลือกโปรแกรมมิลค์เชค กดปุ่มเริ่ม/หยุด	1 นาที



ฟังก์ชันแบบปรับเอง

ฟังก์ชันแบบปรับเองสามารถใช้ได้เพิ่มเติมจากโหมดโปรแกรม

-  **การทำความสะอาด:** สามารถทำความสะอาดเครื่องด้วยน้ำเปล่า 150 มล. และน้ำยาล้างจาน 1 หยด กดปุ่มทำความสะอาด ระยะเวลา 30 วินาที

ใช้เวลาในการทำงานนานสูงสุดไม่เกิน 3 นาที

-  **การปั่น:** สามารถควบคุมวิธีการปั่นได้อย่างอิสระตามต้องการ กดปุ่มปั่น หน้าจอจะแสดง "P" ที่สอดคล้องกับฟังก์ชันหยุดเป็นจังหวะ แต่สามารถเลือกความเร็วในการปั่นจาก 1 ถึง 9 โดยกดปุ่มตั้งค่า +/- (L) "H" คือความเร็วสูงสุด จากนั้นกดปุ่มเริ่ม/หยุด สามารถตั้งเวลาการทำงานโดยกดปุ่มตั้งค่า +/- (L) ระหว่าง 5 วินาทีถึง 3 นาที เวลาที่เหลือจะปรากฏในหน้าจอ รอให้เครื่องปั่นหยุดโดยอัตโนมัติ เครื่องจะส่งเสียงเตือน 3 ครั้ง

-  **การทำสัญญาภาค:** ก่อนใช้ฟังก์ชันสัญญาภาค ล็อกฝาจากปิดโดยหมุนลูกศรบนฝาจากปิดให้อยู่ในทิศทางแนวเดียวกับรูปภาพ "ใส่อากาศ"  เริ่มกระบวนการทำสัญญาภาค หลังจาก 1 นาที 10 วินาที จะสามารถเลือกโปรแกรมอัตโนมัติ (สามารถใช้กับโปรแกรมสมูทตี้และมิลค์เชค) เมื่อโปรแกรมสิ้นสุดการทำงาน กดปุ่มสัญญาภาคตรงกลางฝาจากปิด และถอดฝาเพื่อนำจากปิดออก แล้วเทอาหาร

ฟังก์ชันอื่น ๆ

- กดปุ่ม "เริ่ม/หยุด" เพื่อหยุดโปรแกรมชั่วคราว สามารถหยุดเครื่องชั่วคราวสูงสุด 5 นาที หลังจากที่เครื่องกลับสู่หน้าจอหลัก
- หากกดปุ่ม "เริ่ม/หยุด" ค้างเป็นเวลา 3 วินาที เครื่องจะส่งเสียงเตือน 3 ครั้ง ก่อนเข้าสู่โหมด "สแตนด์บาย" ไม่มีไฟปุ่มใดปรากฏยกเว้นปุ่ม "เริ่ม/หยุด"

ระบบป้องกันปริมาณเกินจำกัด

- เครื่องใช้นี้มีระบบป้องกันปริมาณเกินจำกัด ซึ่งจะป้องกันมอเตอร์ไม่ให้เกิดความเสียหายจากปริมาณเกินจำกัด
- หากเครื่องปิดระหว่างการใช้งาน ปฏิบัติตามขั้นตอนต่อไปนี้
 - ปิดเครื่องโดยใช้ปุ่มเริ่ม/หยุด ถอดปลั๊กแล้วปล่อยให้เย็นลงเป็นเวลาประมาณ 15-20 นาที
 - เชื่อมต่อเครื่องกับแหล่งจ่ายไฟอีกครั้ง แล้วจึงปั่นต่อ
- **การยกเลิก:** สามารถหยุดการปั่นในระหว่างรอบการทำงานโดยกดสัญลักษณ์ "ยกเลิก" เครื่องจะหยุดและกลับสู่หน้าจอหลัก

การทำความสะอาด

- ทำความสะอาดโถปั่นทันทีหลังการใช้งาน
- สำหรับการทำความสะอาดแบบง่าย สามารถใช้โปรแกรมทำความสะอาด –ใส่น้ำเปล่า 150 มล. และนํายาล้างจาน 1 หยดในโถปั่น กดปุ่มทำความสะอาดสะอาด
- การใช้นํายาล้างจานในปริมาณที่มากเกินไปจะทำให้เกิดฟองมาก และอาจไหลล้น หลังจากนั้นจึงใช้ฟองน้ำเช็ดโถปั่น
- ล้างโถปั่นด้านในและฝาปิดผ่านน้ำไหล
- หากต้องทำความสะอาดเครื่องมากเป็นพิเศษ สามารถใช้ส่วนผสมของน้ำอุ่นและเบกกิ้งโซดา แช่ทิ้งไว้เป็นเวลาสองถึงสามชั่วโมงเพื่อช่วยให้สะอาด
- ใช้ผ้าบิดหมาดเช็ดทำความสะอาดชุดมอเตอร์ (D) ทำให้แห้งด้วยความระมัดระวัง
- สามารถทำความสะอาดชิ้นส่วนที่ถอดได้ (ฝาปิด ฝาจุกปิด ถ้วยตวง) โดยใช้ฟองน้ำและนําร้อนผสมนํายาล้างจาน นอกจากนี้ ใช้แปรงเพื่อทำความสะอาดด้านในของโถปั่นได้เช่นกัน

ข้อควรระวัง:

- ตรวจสอบให้แน่ใจว่าไม่มีอาหารหรือของเหลวหลงเหลือในโถปั่น โถปั่นไม่ได้ออกแบบมาเพื่อเก็บอาหารในตู้เย็นหรือช่องแช่แข็ง
- ในการทำความสะอาดด้านนอกของชุดมอเตอร์และตัวโถปั่น ให้ใช้ผ้าชุบน้ำหมาด ๆ
- ห้ามแช่ตัวเครื่องในน้ำ (ไม่ว่าจะเป็นชุดมอเตอร์หรือฐานรองโถปั่น) ห้ามล้างชุดมอเตอร์ (D) ผ่านน้ำไหล
- ห้ามล้างโถปั่น ฝาจุกปิดในเครื่องล้างจาน

ต้องทำอะไรหากเครื่องไม่ทำงาน?

ปัญหา	สาเหตุ	วิธีแก้ไข
เครื่องไม่ทำงาน	ไม่ได้เสียบปลั๊ก	เชื่อมต่อเครื่องกับเต้าเสียบที่มีแรงดันไฟฟ้าเท่ากันตามที่ระบุไว้ในป้ายแสดงของเครื่อง
	โถบั่นวางอยู่ในตำแหน่งที่ไม่ถูกต้องบนชุดมอเตอร์ หรือ โถบั่นและฝาปิดเข้าที่อย่างถูกต้อง แต่ไม่ล็อกเข้ากับชุดมอเตอร์	ตรวจสอบว่าโถบั่นและฝาปิดวางอยู่บนชุดมอเตอร์อย่างเหมาะสมตามที่อธิบายไว้ในคำแนะนำ
	เครื่อง ผงปุม หรือโปรแกรมไม่ตอบสนอง	ถอดปลั๊กเครื่อง รอ 1 นาที แล้วเสียบปลั๊กอีกครั้ง
	ในกรณีที่ความร้อนสูงเกินไป	ปิดเครื่องโดยใช้ปุ่มเริ่ม/หยุด ถอดปลั๊กแล้วปล่อยให้เย็นลงเป็นเวลาประมาณ 15-20 นาที
	การล้น	ลดปริมาณของส่วนผสมที่ใช้
เครื่องหยุดขณะใช้งาน	ปริมาณเกินจำกัดหรือความร้อนสูงเกินไป	ปิดเครื่องโดยใช้ปุ่มเริ่ม/หยุด ถอดปลั๊กแล้วปล่อยให้เย็นลงเป็นเวลาประมาณ 15-20 นาที เชื่อมต่อเครื่องกับแหล่งจ่ายไฟอีกครั้ง แล้วจึงบั่นต่อ
การสันสะท้อนมากเกินไป	วางผลิตภัณฑ์อยู่บนพื้นผิวที่ไม่ราบเรียบ	วางผลิตภัณฑ์บนพื้นผิวที่ราบเรียบ
	ปริมาณของส่วนผสมสูงเกินไป	ลดปริมาณของส่วนผสมที่ใช้
การรั่วไหลหรือการล้นจากฝาปิด	ปริมาณของส่วนผสมสูงเกินไป	ลดปริมาณของส่วนผสมที่ใช้
	วางฝาปิดไม่ถูกต้อง	วางฝาปิดให้ถูกต้องบนโถบั่น
การรั่วไหลจากด้านล่างของโถบั่น	การเสื่อมสภาพของการกันน้ำของเครื่อง	ข้อควรระวัง: ชุดใบมีดไม่สามารถถอดออกได้ กรุณาติดต่อฝ่ายบริการลูกค้าดูข้อมูลติดต่อได้ในใบรับประกัน

ปัญหา	สาเหตุ	วิธีแก้ไข
ใบมีดหมุนได้ยาก	อาหารชิ้นใหญ่หรือแข็งเกินไป	ลดขนาดหรือปริมาณของส่วนผสมที่ใช้
	ของเหลวที่ปั่นแล้วร้อนเกินไป และทำให้ปะเก็นซิลิโคนผิดรูป	กรุณาติดต่อฝ่ายบริการลูกค้า ดูข้อมูลติดต่อได้ในใบรับประกัน
ปัญหาในการทำอาหาร	อาหารสุกไม่พอหรือ/อาหารสุกเกินไป	ใช้ฟังก์ชันแบบปรับเองเพื่อปรับเวลาการใช้งานและอุณหภูมิการทำความร้อน
	อาหารติดกันเครื่อง	ใช้ฟังก์ชันแบบปรับเองเพื่อปรับเวลาการใช้งานและอุณหภูมิการทำความร้อน และดูคำแนะนำในการทำอาหารทำความสะอาด
ทำอาหารออกมาได้ไม่ดี	ใช้โถปั่นที่ไม่เหมาะสม	ตรวจสอบว่าใช้โถปั่นอย่างเหมาะสม
	เซ็นเซอร์เตือนการล้นที่อยู่ใฝ่ามีดโถปั่นแบบร้อนไม่สะอาด	ทำความสะอาดชิ้นส่วนฝาปิดโถปั่นแบบร้อนทั้งหมด

หากเครื่องยังคงทำงานไม่เหมาะสม กรุณาติดต่อฝ่ายบริการลูกค้าในประเทศของคุณ

안전 경고

주의: 안전상 주의사항에 따라 제품을 사용하십시오. 새로운 제품을 처음 사용하기 전에 설명서를 주의 깊게 읽어 보시기 바랍니다. 또한 나중에 참조할 수 있도록 찾기 쉬운 곳에 잘 보관하십시오.

본 제품은 용기가 본체(D)에 올바르게 장착되고 용기의 뚜껑이 닫혀 있을 경우에만 작동합니다.

각부 명칭

- | | | | |
|---|---|---|-------------|
| A | 뚜껑 캡
뚜껑
찬 음식 조리를 위한 플라스틱
트라이탄 용기 | E | 세척용 솔 |
| B | 뚜껑 캡
뚜껑
따뜻한 음식 조리를 위한 유리
용기 | F | 화면 |
| C | 누름봉 | G | 시작/정지 버튼 |
| D | 본체 | H | 자동 프로그램 |
| | | I | 세척 버튼 |
| | | J | 분쇄 버튼 |
| | | K | 취소 버튼 |
| | | L | 속도/시간 설정 버튼 |
| | | M | 계량컵 |
| | | N | 용기 표시기 |

제품을 처음 사용하기 전에

- 제품을 처음 사용하기 전에 음식물과 접촉하는 부품(용기, 뚜껑, 계량 컵)을 비눗물로 세척합니다.

주의: 본체와 용기 하단부를 포함하여 제품을 물속에 담그지 마십시오. 본체(D)가 흐르는 물에 절대 닿지 않도록 하십시오. 젖은 천으로 닦은 후 잘 건조합니다.

칼날은 매우 날카로우며 탈부착할 수 없습니다.

- 제품을 작동시키기 전에 모든 포장재를 제거합니다.

제품 사용

- 제품은 열원으로부터 떨어져 있으며 물이 튀지 않는 흔들림 없는 평평한 내열 바닥 위에 올려놓고 사용합니다.
- 용도에 맞는 용기(A 또는 B)를 본체에 올바르게 장착합니다. 그림 1 및 2.
- 용기를 받침에서 빼고 최소 6초 후 다른 용기를 놓습니다.



ok 따뜻한 음식 조리를 위한 유리 용기:

- 다음과 같이 표기된 최대 용량을 초과하지 않도록 재료를 추가:
 - 뜨거운 음식 조리 시 최대 1400ml

자동 기능:

사용법:

- 용기의 뚜껑을 닫은 후 뚜껑에 뚜껑 캡을 고정합니다. 제품은 용기와 뚜껑이 제대로 장착되어 있을 경우에만 작동합니다.
- 제품에 플러그를 꼽고 스위치를 켜면 경고음이 울리고 화면이 켜집니다.
- 제품은 대기 상태가 됩니다. 이 단계에서 화면에 표시되는 프로그램을 선택할 수 있습니다. 버튼이 깜박이고 조리 시간 정보가 표시됩니다.
- 시작/정지 버튼을 누릅니다. 그러면 제품이 자동으로 작동하기 시작합니다.
- 조리가 끝나면 블렌더는 자동으로 작동을 멈춥니다. 종료 알림음이 3번 울립니다.
- 프로그램이 진행되는 동안 블렌더 작동을 멈출 수 있습니다:
 - <<시작/정지>> 버튼을 눌러 프로그램을 일시 중지합니다(최대 5분 후 장치가 홈 화면으로 돌아갑니다)
 - <<최소>> 버튼을 눌러 프로그램을 중지하고 홈 화면으로 돌아갑니다.
- 고온 프로그램 및 쿠키 기능의 경우, 작동 중에 전원이 꺼진 경우, 3분 이내에 전원이 다시 켜지면, 자동으로 다시 시작 됩니다.
- 제품을 3분 동안 사용하지 않으면 화면 표시등이 꺼지고 시작/정지 버튼만 켜집니다.

주의:

- 블렌더가 작동 중일 때 본체 또는 용기를 흔들지 마십시오.

주의: 특히 조리 시간이 긴 프로그램을 한 번 실행한 후에는 최소 5분간 기다렸다가 블렌더를 다시 사용하시기 바랍니다.

고온 프로그램의 경우, 표시된 시간은 재료의 초기 온도와 양에 따라 달라질 수 있는 예열 시간을 고려하지 않습니다(5분에서 15분 사이). 시작/정지 버튼을 누릅니다. 조리 잔여 시간이 표시 됩니다.

프로그램 진행 동안 블렌더의 뚜껑을 열면 제품 안전성으로 인해 제품이 자동으로 멈춥니다.



주의: 뜨거운 음식을 조리할 때는 도중에 재료를 추가로 넣지 않을 것을 권장합니다. (음식물이 될 수 있습니다). 뜨거운 음식을 조리하는 동안에는 뚜껑(B2)에서 뚜껑 캡(B1)을 빼지 마십시오. 매우 뜨거워 화상을 입을 수 있습니다.

따뜻한 음식 조리 프로그램: 수프, 따뜻한 소스, 소스, 잼, 곡물라떼.

뜨거운 음식 조리 프로그램	조리법	단계별	시간
 수프	호박 600g, 감자 120g, 양파 80g, 물 600g.	수프 프로그램 선택 시작/정지 버튼 누름	30분
 따뜻한 소스	우유 500ml, 버터 45g, 일반 밀가루 45g, 넛맥 (1꼬집)	핫 소스 프로그램 선택 시작/정지 버튼 누름	15분
 소스	물 100ml, 레몬 주스 60ml, 설탕 100g, 블루베리 250g, 딸기 250g.	쿨리스 프로그램 선택 시작/정지 버튼 누름	15분
 잼	맛있는 사과 700g, 물 100ml.	콤포트 프로그램 선택 시작/정지 버튼 누름	15분
 곡물라떼	통 아몬드 100g, 물 1L	잡곡 우유 프로그램 선택 시작/정지 버튼 누름	25분

수동 기능:

수동 기능은 자동 프로그램 모드 외에도 사용할 수 있습니다.

- 
세척: 150ml의 물과 1방울의 세제로 기기를 청소할 수 있습니다. 세척 버튼을 누릅니다. 지속 시간은 30초입니다. 기기를 3분이상 연속 사용 하지 마십시오.
- 
분쇄: 분쇄 방식을 자유롭게 설정할 수 있는 기능입니다. 분쇄 버튼을 누르면 화면에 펄스(순간작동) 기능에 해당하는 <<P>>가 표시되지만 설정 +/- 버튼(L)을 눌러 분쇄 속도를 1에서 9까지 선택할 수 있습니다. <<H>>는 최고 속도입니다. 이후 시작/정지 버튼을 누릅니다. +/- 버튼(L)을 5초에서 3분 사이에서 눌러 작업 시간을 설정할 수 있습니다. 잔여 시간은 화면에 표시됩니다. 블렌더가 자동으로 작동을 멈출 때까지 기다립니다. 분쇄가 완료 되면 종료음이 3번 울립니다.



가열: 가열 방식을 자유롭게 설정할 수 있는 기능입니다. 가열 버튼을 누르면 화면에 《75》가 표시되지만 프로그램 +/- 설정 버튼(L)을 눌러 40°부터 100°까지 가열 온도를 선택할 수 있습니다. +/- 버튼(L)을 5분에서 90분 사이에서 눌러 작업 시간을 설정할 수 있습니다. 시작/정지 버튼을 누릅니다. 잔여 시간은 화면에 표시됩니다. 가열이 자동으로 작동을 멈출 때까지 기다립니다. 프로그램이 끝나면 제품은 3번 삐 소리를 냅니다. 시작/정지 버튼 또는 취소 버튼을 눌러서 진행되는 동안 가열을 중지시킬 수도 있습니다.



ok 시원한 음식 조리를 위한 플라스틱 트라이탄 용기

- 다음과 같이 표기된 최대 용량을 초과하지 않도록 재료를 추가:
-  시원한 음식 조리 시 최대 1750ml

자동 기능

사용법:

- 용기의 뚜껑을 닫은 후 뚜껑에 뚜껑 캡을 고정합니다. 제품은 용기와 뚜껑이 제대로 장착되어 있을 경우에만 작동합니다.
- 제품에 플러그를 꼽고 용기를 본체에 장착하면 준비 알림음이 울리고 화면이 켜집니다.
- 제품은 대기 상태가 됩니다. 이 단계에서 화면에 표시 되는 프로그램을 선택할 수 있습니다. 버튼이 깜박이고 레시피 시간 정보가 표시됩니다.
- 각 자동 프로그램을 시작하기 전에 '진공 버튼'을 눌러 진공 기능을 사용할 수 있습니다: 1분 10초
- 진공 기능을 사용할 때는 뚜껑 캡이 단단히 조여 있는지 확인하십시오.
- 시작/정지 버튼을 누르면 기기가 시작됩니다. 조리가 끝나면 블렌더가 자동으로 멈춥니다. 제품은 3번 삐 소리를 냅니다.
- 블렌더 기능을 사용하는 경우, 프로그램이 완료되면 뚜껑 캡의 중간을 눌러 뚜껑을 엽니다.
- 프로그램이 진행되는 동안에도 블렌더 작동을 멈출 수 있습니다:
- 《시작/정지》 버튼을 눌러 프로그램을 일시 중지합니다(최대 5분 후 장치가 홈 화면으로 돌아갑니다)
- 《취소》 버튼을 눌러 프로그램을 중지하고 홈 화면으로 돌아갑니다
- 조리를 돕기 위해 누름봉을 사용할 수 있습니다(진공 기능이 없는 경우)
- 고온 음식 재료에는 이 용기를 사용하지 마십시오.
- 뚜껑을 물에 담그지 마십시오.

찬 음식 조리에 한하여 블렌딩하는 도중에 재료를 추가하려면 뚜껑(B)에서 뚜껑 캡(A)을 빼고 그 투입구를 통해 재료를 넣습니다. 음식물이 튀

수 있으니 조심하시기 바랍니다.



주의: 진공 동안에는 뚜껑에서 뚜껑 캡(A)을 빼지 마십시오



시원한 음식 조리 프로그램: 스무디(주스), 아이스크림, 땅콩버터, 얼음 분쇄, шей크

찬 음식 조리 프로그램	조리법	단계별	시간
 스무디 (주스)	껍질 벗긴 그레니 스미스 (사과 2개) 240g, 셀러리 줄기 60g(잎 없음), 오이 200g, 케일 잎 20g, 라임 주스 80g, 물 400g, 아가베 시럽 60g, 시금치 잎 20g.	삭제 스무디(주스) 프로그램 선택 시작/정지 버튼 누름	1분 10초
 아이스크림	냉동 딸기 450g + 우유 240ml + 설탕 130g	아이스크림 프로그램 선택 시작/정지 버튼 누름	1분 10초
 땅콩 버터	무염 땅콩 400g + 슬라이스 아몬드 75g + 피칸 너트 125g	땅콩 버터 프로그램 선택 시작/정지 버튼 누름	2분 15초
 얼음 분쇄	8개의 얼음 조각 30x30x40mm	얼음 분쇄 프로그램 선택 시작/정지 버튼 누름	1분
 шей크	바닐라 아이스크림 250g + 바나나 1개(100g) + 우유 250ml	셰이크 프로그램 선택 시작/정지 버튼 누름	1분

수동 기능

수동 기능은 프로그램 모드 외에도 사용할 수 있습니다.

-  **세척:** 150ml의 물과 1방울의 세제로 기기를 청소할 수 있습니다. 세척 버튼을 누릅니다. 지속 시간은 30초입니다. 가장 긴 작업 시간은 3분을 초과할 수 없습니다.
-  **분쇄:** 분쇄 방식을 자유롭게 설정할 수 있는 기능입니다. 분쇄 버튼을 누르면 화면에 순간 작동 기능에 해당하는 <P>가 표시되지만 설정 +/- 버튼(L)을 눌러 분쇄 속도를 1에서 9까지 선택할 수 있습니다. <H>는 최고 속도입니다. 이후 시작/정지 버튼을 누릅니다. +/- 버튼(L)을 5초에서 3분 사이에서 눌러 작업 시간을 설정할 수 있습니다. 잔여 시간은 화면에 표시됩니다. 블렌더가 자동으로 작동을 멈출 때까지 기다립니다. 종료음이 3번 울립니다.

- 
진공: 진공 기능을 사용하기 전에 뚜껑 캡의 화살표가 "공기 배출" 그림 문자와 일치하도록 뚜껑 캡을 돌려서 잠급니다.  진공 과정을 시작합니다. 1분 10초 후, 자동 프로그램 (스무디 및 셰이크 프로그램과 호환 가능)을 선택할 수 있습니다. 프로그램 종료 시, 뚜껑 캡 중앙에 있는 진공 버튼을 누르고 캡을 제거하여 뚜껑을 열고 내용물을 붓습니다.

기타 기능

- 《시작/정지》버튼을 눌러 프로그램을 정지시킬 수 있습니다. 제품은 최대 5분간 일시 중지할 수 있으며 그 후 제품은 홈 화면으로 돌아갑니다.
- 《시작/정지》 버튼을 3초 동안 계속 누르고 있으면 기기는 《대기》 모드로 들어가기 전에 3 번 삐 소리를 울립니다. 다른 기능의 버튼은 보이지 않고 <<시작/정지>>버튼만 확인 됩니다.

KO

과부하 방지

- 본 제품에는 과부하 방지 시스템이 장착되어 있습니다. 이 기능은 모터가 과부하로 손상되는 것을 방지해 줍니다.
- 작동 중 제품의 전원이 꺼진 경우에는 다음과 같이 조치하시기 바랍니다:
 - 시작/정지 버튼을 눌러 제품의 전원을 끄고 플러그를 뽑은 다음 약 15-20분 동안 제품의 열기를 식힙니다.
 - 이후에 다시 전원을 연결하고 블렌더를 재작동시킵니다.
- **취소:** 작동 중 블렌딩을 중지하려면 《취소》 버튼을 누릅니다. 기기가 작동을 멈추고 홈 화면으로 돌아갑니다.

청소

- 사용 후 즉시 용기를 세척합니다.
- 세척 프로그램을 사용하여 간편하게 제품을 세척할 수 있습니다:
 - 물 150ml와 액체 주방세제 1방울을 용기에 넣습니다. 세척 버튼을 누릅니다.
- 세제를 너무 많이 넣으면 거품이 과도하게 생성되어 용기 밖으로 넘쳐 흐를 수 있습니다. 스펀지로 용기를 닦고 세척을 마무리합니다.
- 흐르는 물에 용기 안쪽과 뚜껑을 행궤 줍니다.
- 용기를 꼼꼼하게 청소해야 하는 경우 온수와 베이킹 소다를 혼합하여 사용할 수 있습니다. 용기에 베이킹 소다와 온수가 혼합된 물을 몇 시간 동안 담가 두면 쉽게 세척이 더 쉬워 집니다.
- 젖은 천으로 본체(D)를 닦아줍니다. 잘 건조시킵니다.
- 분리 가능한 부품(뚜껑, 뚜껑 캡, 계량 컵)은 스펀지와 뜨거운 비눗물로

세척할 수 있습니다. 세척솔을 사용하여 용기 내부를 청소할 수도 있습니다.

주의:

- 용기 안의 음식물이나 액체를 모두 비웁니다. 용기에 음식물을 넣어 냉장고 또는 냉동고에 보관하지 마십시오.
- 본체 외부와 용기 벽을 청소하려면, 젖은 천을 사용하십시오.
- 본체와 용기 하단부를 포함하여 제품을 물속에 담그지 마십시오. 본체 (D)를 흐르는 물에 절대 닿지 세척하지 마십시오.
- 용기, 뚜껑 캡은 절대 식기 세척기에 넣지 마십시오.

제품이 정상적으로 작동하지 않을 경우

문제	원인	해결 방법
제품이 작동하지 않는 경우	플러그가 연결되지 않았습니다.	제품에 표기 된 경격 전압과 일치하는 콘센트에 플러그를 연결 합니다.
	블렌더 용기가 본체에 제대로 장착되어 있지 않거나 용기 및 뚜껑이 제 위치에 있지 않아 제품이 작동 되지 않습니다.	블렌더 뚜껑이 용기에 제대로 닫혀있는지 확인 한 다음, 본체에 정확히 장착 시켜 줍니다.
	제품, 버튼 또는 프로그램이 반응하지 않음	제품의 플러그를 뽑고 1 분간 기다린 다음 다시 플러그를 연결합니다.
	제품 과열	시작/정지 버튼을 눌러 제품의 전원을 끄고 플러그를 뽑은 다음 약 15-20분 동안 제품의 열기를 식힙니다.
	넘침	조리할 재료의 양을 줄입니다.
제품 사용 중 작동이 멈춤	과부하 또는 과열	시작/정지 버튼을 눌러 제품의 전원을 끄고 플러그를 뽑은 다음 약 15-20분 동안 제품의 열기를 식힙니다. 이후에 다시 전원을 연결하고 블렌더를 재작동시킵니다.
과도한 진동	제품이 평평한 곳에 놓여 있지 않습니다.	평평한 바닥에 제품을 놓고 사용하십시오.
	재료의 양이 너무 많습니다.	조리할 재료의 양을 줄입니다.
뚜껑으로 음식이 새거나 넘쳐 흐르는 경우	재료의 양이 너무 많습니다.	조리할 재료의 양을 줄입니다.

문제	원인	해결 방법
블렌더 용기 하단에서 음식이 새어 나오는 경우	제품의 방수 기능이 손상되었습니다.	주의: 칼날은 탈부착할 수 없습니다. 고객 서비스 센터에 문의하십시오. 연락처 정보는 보증서에서 찾을 수 있습니다.
칼날이 제대로 회전하지 않는 경우	음식이 너무 크거나 단단합니다.	조리할 재료의 양이나 크기를 줄입니다.
	블렌딩한 액체가 너무 뜨겁거나 본체의 실리콘 패키징이 손상되었습니다.	고객 서비스 센터에 문의하십시오. 연락처 정보는 보증서에서 찾을 수 있습니다.
가열 기능 관련	음식이 충분히 조리되지 않거나 음식이 과도하게 조리됩니다.	+, -속도/시간 설정 버튼을 눌러 조리 시간과 가열 온도를 적절히 조절하십시오.
	음식이 바닥에 늘어붙습니다.	+, -속도/시간 설정 버튼을 눌러 조리 시간과 가열 온도를 적절히 조절하십시오. 또한 세척 관련 설명을 참고하십시오.
조리 결과가 만족스럽지 않습니다.	적절한 용기가 사용되지 않습니다	가열 음식 조리 시 유리 용기를 사용 하셔야 하고 찬 음식 조리 시 트라이탄 용기를 사용하셔야 합니다.
	뜨거운 용기 뚜껑에 놓인 넘침 센서가 깨끗하지 않습니다.	뜨거운 용기 뚜껑의 모든 부분을 청소하십시오.

제품이 여전히 제대로 작동하지 않는다면 거주하시는 국가의 고객 서비스 센터에 문의하십시오.

EN p. 5 – 13

ZH p. 14 – 21

VI p. 22 – 30

MS p. 31 – 40

TH p. 41 – 49

KO p. 50 – 58