

# Tefal®

## OptiGrill 4in1

EN  
DE  
NL  
FR  
IT



Instructions for use - Bedienungsanleitung  
Instructies voor gebruik - Mode d'emploi  
Istruzioni d'uso

Please read the “Use & Safety instructions” booklet carefully before first use.

Bitte lesen Sie die Broschüre „Gebrauchs- und Sicherheitshinweise“ vor dem ersten Gebrauch sorgfältig durch.

Neem vóór het eerste gebruik het boekje met de veiligheids- en gebruiksinstructies aandachtig door.

Veillez lire attentivement le livret “Consignes de sécurité et d’utilisation“ avant la première utilisation.

Leggere con attenzione il libretto “Norme di sicurezza e d’uso” prima del primo utilizzo.

## TABLE OF CONTENTS

• Product description	4
• Positions and interfaces	5
• Change position	6
• Cooking level indicator	7
• Before first use	8
• 1. Grill position	9
a) Using an automatic program	9
b) Using the manual mode	12
c) Cooking guide	13
• 2. Oven position	14
• 3. Barbecue position	16
• 4. Complete meal position	17
• End of use	18
• Cleaning	19
• Troubleshooting guide	20

## PRODUCT DESCRIPTION

- A. Control panel
- A1. On/Off button
- A2. Frozen food function
- A3. 9 automatic cooking programs
- A4. Manual mode with 4 temperatures
- A5. Confirm selection and start preheating
- A6. Cooking level indicator
- B. Release latch for barbecue and complete meal positions
- C. Side thermostat for barbecue and complete meal positions
- D. Indicator light for barbecue and complete meal positions
- E. Front drip tray
- F. Back drip tray
- G. Baking tray
- H. Bottom plate
- I. Top plate
- J. Power cord

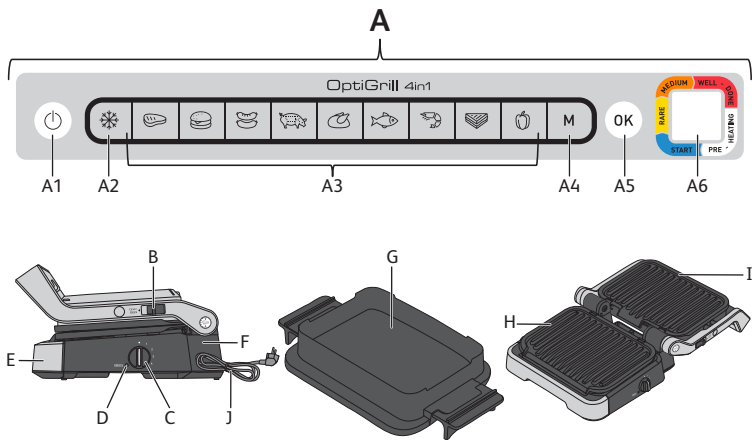

## POSITIONS AND INTERFACE

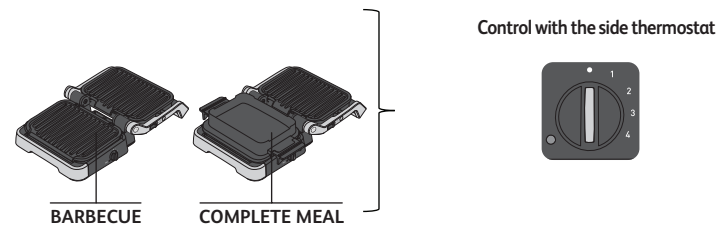
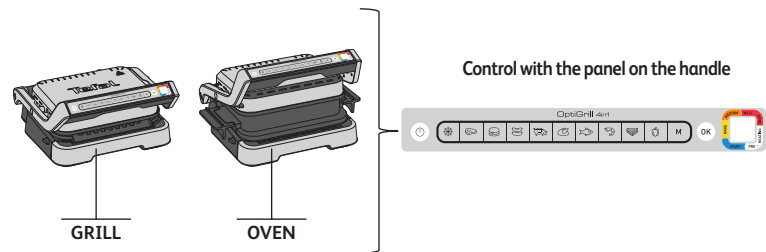

## CHANGE POSITION

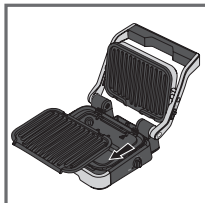
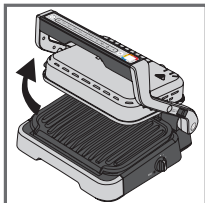

### Change to oven position:

Open the grill, remove the lower grill plate and replace with the baking tray.

**Caution:** The baking tray is placed on the grill without being locked into place.

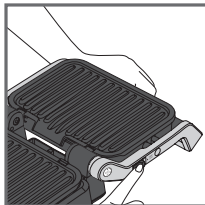
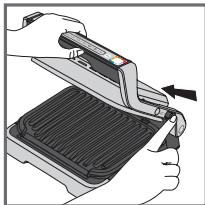

### Change to barbecue position:

When opening the grill, hold the latch up and bring the handle to the 180° open barbecue position.

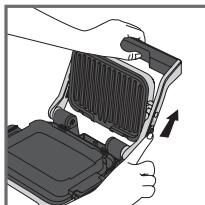
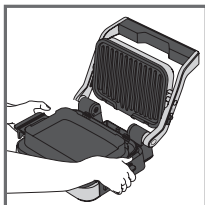

### Change to complete meal position:

Plug the baking tray in place of the lower plate, then open the grill to the 180° position following the steps above.

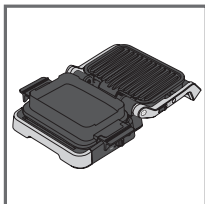

**Caution:** Check that the thermostat on the side is on **•** before opening the grill in barbecue or complete meal position. If the thermostat is not on **•**, the grill will start heating up and will notify you of this with a beep.

## COOKING LEVEL INDICATOR

### Preheating



Flashing white coloured light: preheating in progress

>



Steady white coloured light and beeping: ready to cook

### Cooking



First cooking level in progress



First cooking level reached



Rare level in progress



Rare level reached



Medium level in progress



Medium level reached



Well-done level in progress



Well-done level reached

For each automatic program, Optigrill lets you know when your food has reached the desired cooking level. When a cooking level is reached, the grill beeps to notify you.

## BEFORE FIRST USE

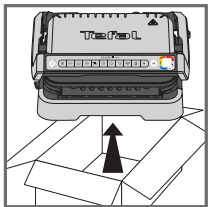

1

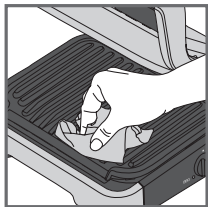

2

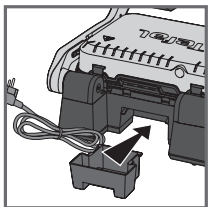

3

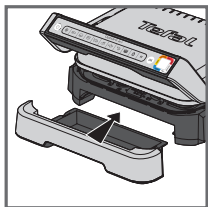

4

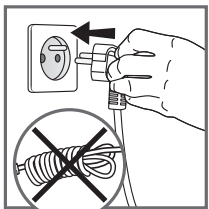

4

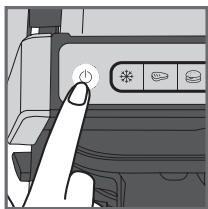

5

1. Remove all packaging materials, stickers and accessories from the inside and the outside of the appliance. Additional colour ring stickers are provided. You can stick your preferred language on the original colour ring.
2. Before using for the first time, thoroughly clean the plates with warm water and a little dishwashing liquid, rinse and dry thoroughly.
3. Position the removable drip trays at the front and at the back of the appliance.
4. Make sure that the upper and lower plates are correctly positioned in the product. Do not activate preheating without the plates. Connect the appliance to the mains supply (the cable must be completely unwound).
5. Press the on/off button.

**Caution :** Make sure there is no food between the plates

## 1. GRILL POSITION

### A) USING AN AUTOMATIC PROGRAM

9 automatic programs:  
red meat, burger, sausage, pork, chicken, fish,  
seafood, sandwich, pepper

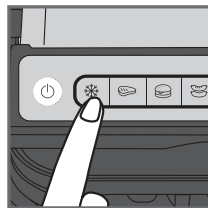

1

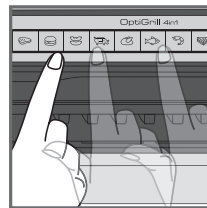

2

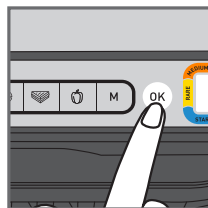

3

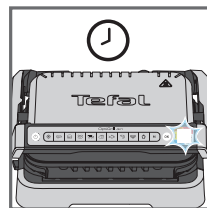

4

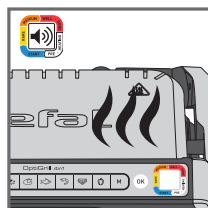

5

1. If the food you wish to cook is frozen, press the corresponding button. This function is only available when cooking with the automatic programs, not in manual mode.
2. Select the appropriate cooking program according to the type of food you wish to cook.

**Tip, especially for meat:** The cooking results on the automatic programs may vary depending on origin, cut and quality of the food being cooked, the programs have been set and tested for good quality food.

Similarly, the thickness of the meat must be taken into account during cooking; you should not cook foods with a thickness greater than 4 cm.

If you are uncertain about which cooking program to use, please refer to the cooking guide page 13.

3. Press the "OK" button: the appliance starts preheating and the cooking level indicator flashes white.

**NB:** If you have selected the wrong program, turn off the appliance and repeat the steps.

4. Wait for preheating to be complete.
5. When the level indicator stops flashing white and the grill beeps, the preheating is complete, the grill is ready to cook.

**Comments:** At the end of preheating, if the appliance remains closed, the safety system will turn off the appliance after a while.

## 1. GRILL POSITION

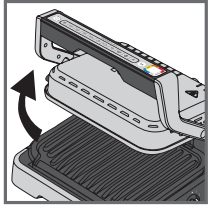

6

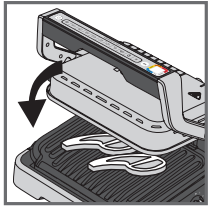
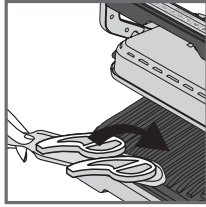

7

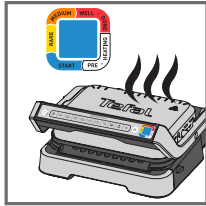

8

6. Open the grill and place the food on the cooking plate.

**Comments:** If the appliance remains open for too long, the safety system will turn off the appliance automatically after a while.

7. Close the appliance to start the cooking cycle. The cooking level indicator turns blue to indicate the cooking is in progress (for the best results, do not open or move your food during the cooking process). The appliance automatically adjusts the cooking cycle (time and temperature) according to the food thickness and quantity.

**Note for very thin pieces of food:** Close the appliance, the button **OK** will flash and the indicator will stay steady white until you press **OK**. Press **OK** to ensure the appliance recognizes the food and that the cooking cycle starts.

8. According to the level of cooking, the indicator light changes color. While cooking is in progress, a beep alerts you each time a cooking level is reached. When the indicator light is yellow with a beep, food is rare, orange with a beep, food is medium and red with a beep, food is well done.

**N.B.:** If you like your meat very rare, remove the meat when the cooking level indicator reaches steady blue.

Please note, especially on meat, it is normal that cooking results vary depending on type, quality and origin of food.

## 1. GRILL POSITION

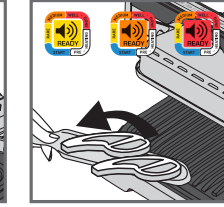
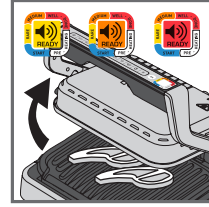

9

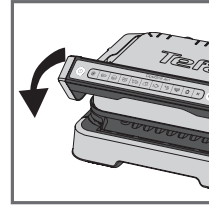

10

9. When the color corresponding to your desired cooking level becomes steady and the beep sounds, open the appliance and remove your food.

**Note:** If you want to cook food to different personal tastes, open the grill and remove the food when it has reached the desired level and then close the grill and continue cooking the other food. The program will continue its cooking cycle until it reaches the final level.

10. When finished cooking, remove food and close the appliance. The control panel will light up and set itself to 'choice of program' mode.

**Comment:** The security system will turn off automatically after a while if no program selection is made

### Keep warm function

Once the red level is reached, the cooking is finished, the appliance automatically activates the keep warm function, the indicator light is red, and the device begins to beep every 20 seconds. If food is left on the grill, it will continue to cook while the cooking plates cool. You may deactivate the beep by pressing the button **OK**.

**Note:** The security system will power off the appliance automatically after a while.

### Cooking a second batch straight away:

Once your first batch of food has finished cooking:

- Make sure that the appliance is closed, and that no food is remaining inside.
- Select the cooking program (this step is necessary even if the program is the same as for the foods you have just finished cooking).
- Press the button **OK** to begin preheating. While preheating, the color level indicator will flash white.
- Once preheating is complete, the appliance will beep, and the indicator light will be steady white.
- The appliance is ready to be used once preheating is complete. Open the grill and place the food inside the appliance.

### Important:

- Please note that preheating is required for each new batch. Before preheating, make sure that the appliance is closed, and that no food is remaining inside. Wait for preheating to finish before opening the grill and placing food inside.
- If the new preheating cycle is activated immediately after the end of the previous cycle, the preheating time will be reduced.

# 1. GRILL POSITION

## B) USING THE MANUAL MODE

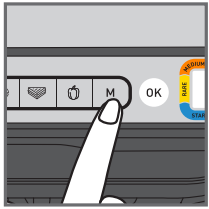

1

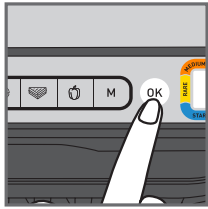

2

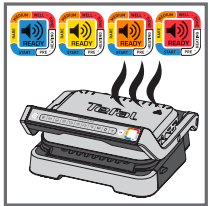

3

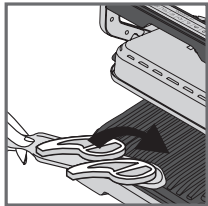

4

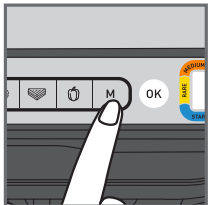

5

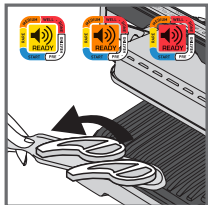

6

1. Select the manual mode and the cooking temperature by clicking on M several times until the colour matches your desired temperature:

	110-125°C
	180-195°C
	220-235°C
	255-275°C

2. Press OK to start preheating. The cooking level indicator flashes with the selected colour : preheating in progress. Wait until preheating is finished.
3. When the desired temperature is reached, the light stops flashing and the grill beeps: the grill is ready to cook.
4. Add the food on the grill, the cooking process begins.
5. You can adjust the temperature during cooking.
6. Watch the food cook and remove it when you consider it cooked as desired.

# 1. GRILL POSITION

## C) COOKING GUIDE

### 9 AUTOMATIC COOKING PROGRAMS

	COOKING LEVEL INDICATOR			
BEEF	Very rare (Blue)	Rare	Medium	Well-done
BURGER	-	Rare	Medium	Well-done
SAUSAGE	-	-	-	Well-done
PORK	-	-	-	Well-done
CHICKEN	-	-	-	Well-done
FISH	-	Medium	Medium well	Well-done
SEAFOOD	-	Medium	Medium well	Well-done
SANDWICH	-	Lightly cooked	Grilled	Crispy
PEPPER	-	-	Lightly grilled	Grilled

### MANUAL MODE IN GRILL POSITION

	from 180°C to 195°C	from 220°C to 235°C	from 255°C to 275°C
POTATOES			
ZUCCHINI / SQUASH			
EGGPLANT			
TOMATOES			
ASPARAGUS			
MUSHROOMS			
ONIONS			
BROCOLI			
BABY CARROTS			
FENNEL			
SWEET POTATOES			
APPLE SLICES			
PINEAPPLE			
PEACH			

## 2. OVEN POSITION

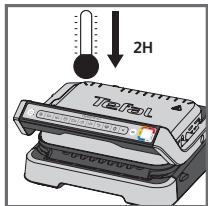

1



2



3

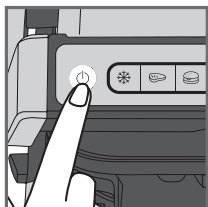
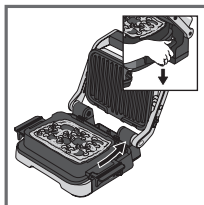

4

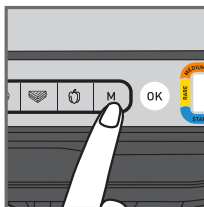

5

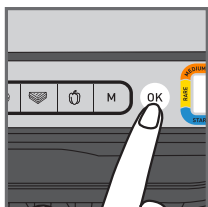



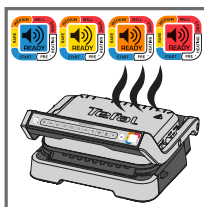

6



7

1. If your OptiGrill is already on and you want to use the baking tray, unplug the grill and let it cool down for at least 2 hours.
2. Put the ingredients in the baking tray.
3. Open the grill, remove the lower grill plate and replace with your baking tray.
4. Close the grill and press the On/Off button.
5. Select the manual mode and the cooking temperature by clicking on M several times until the colour matches your desired temperature:

	85-110°C
	150-165°C
	190-205°C
	240-255°C

6. Begin preheating by pressing the OK button.
7. When the desired temperature is reached, the grill will beep, and the cooking process will begin.

## 2. OVEN POSITION

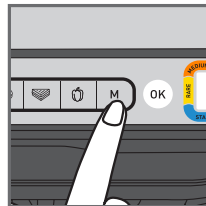

8

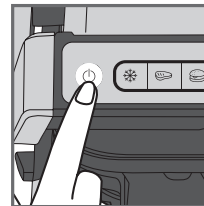

9

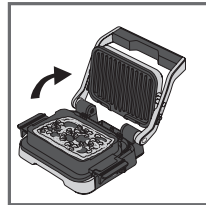

10

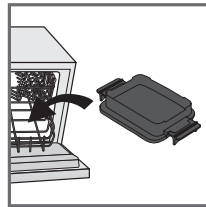

11

8. You can adjust the temperature during the cooking progress.
  9. Watch the food cook. When you consider it cooked as desired, end the cooking by pressing the ON/OFF button. All buttons switch off, the grill stops heating/cooking.
  10. Open the grill and remove the baking tray from the grill using its handles.
  11. The baking tray can go in the dishwasher.
- CAUTION:** Hot surfaces, the use of gloves is recommended. The baking tray is hot, make sure to place it on an adapted surface.



### 3. BARBECUE POSITION

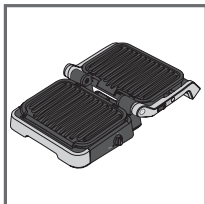

1

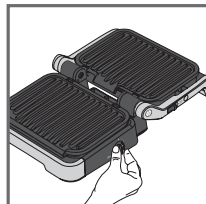

2

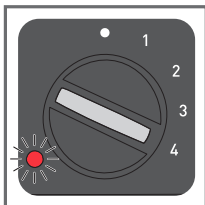

3

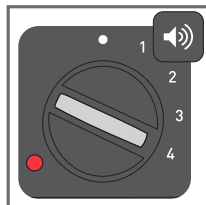

4

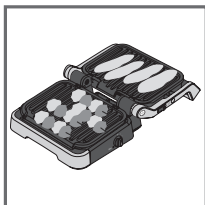

5

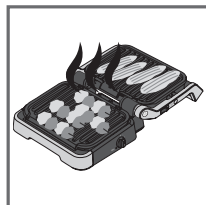

6

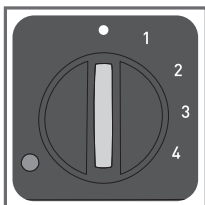

7

1. Open the grill in barbecue position. The cooking is managed with the side thermostat.
2. Select the desired temperature setting. The thermostat sets the same cooking temperature for both plates:

• thermostat off
1: 80-100°C
2: 130-160°C
3: 160-190°C
4: 180-220°C

3. The side light indicator flashes red during preheating.
4. When the light indicator becomes steady red and the grill beeps, the grill is ready to use.
5. Add food on the grill.
6. Watch the food cook and remove it once it is done.
7. Turn off the appliance by setting the thermostat to •.

#### Comments:

- You can change the temperature during cooking. If it is changed during cooking, the grill will adjust the temperature to the new setting.
- If you cook food on one plate only, use the top one.

### 4. COMPLETE MEAL POSITION

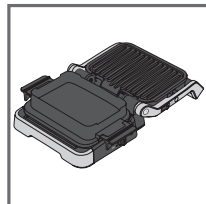

1

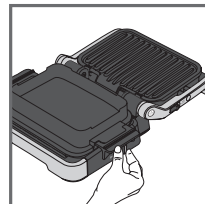

2

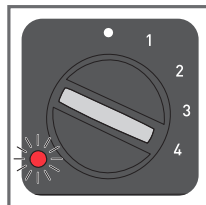

3

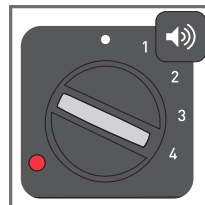

4

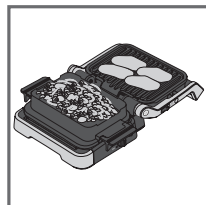

5

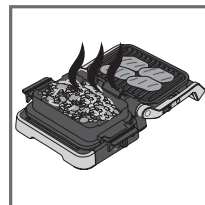

6

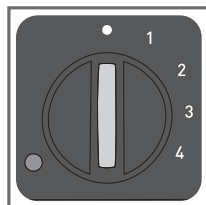

7

1. Put the grill in complete meal position. The cooking is managed with the side thermostat.
2. Select the desired temperature setting. The thermostat controls the cooking temperature for both plates.

• thermostat off
1: 80-100°C
2: 130-160°C
3: 160-190°C
4: 180-220°C

3. The side light indicator flashes red during preheating.
4. When the light indicator becomes steady red and the grill beeps, the grill is ready to use.
5. Add food on the grill and in the baking tray.
6. Watch the food cook and remove it once it is done.
7. Turn off the appliance by setting the thermostat to •.

#### Comment:

- You can change the temperature during cooking. If it is changed during cooking, the grill will adjust the temperature to the new setting.

#### Tips:

If your side dish takes longer to cook than what you're grilling, you can also start cooking in oven position. If you are doing this, please refer to page 14 and follow steps 1 to 7. When the food is cooked as desired, open your grill in barbecue position. The grill automatically switches to the thermostat on the side. Choose the desired temperature setting using the thermostat. When the grill plate has preheated, put the food on it.

## END OF USE

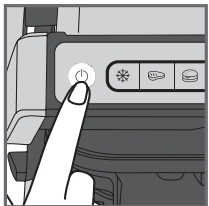

1

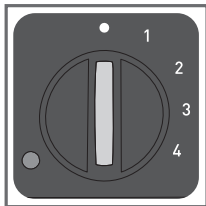

1. Turn off the appliance:
  - Press the on/off button on the handle in grill/oven positions.
  - Set the side thermostat to • in barbecue/ complete meal positions.
2. Unplug the appliance from outlet.
3. Allow to cool for at least 2 hours. To avoid accidental burns, allow grill to cool thoroughly before cleaning.

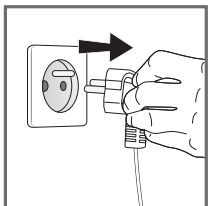

2

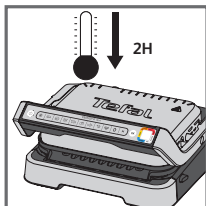

3

## CLEANING

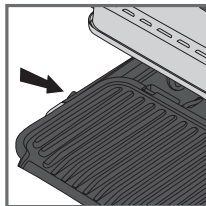

1

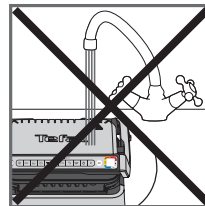

2

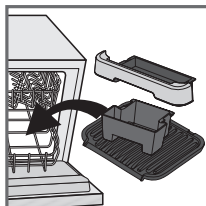

3

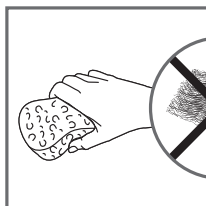

4

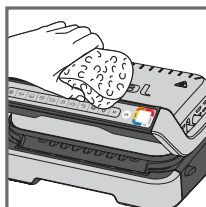
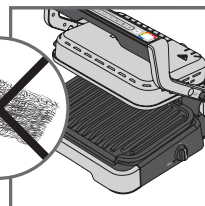

5

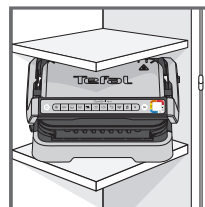









6

1. Before cleaning, unlock and remove the plates, drip trays, and baking tray to prevent damage to the cooking surface. Drain the juice drip trays and wash them in mild soapy water, then dry thoroughly with a paper towel.
2. Do not immerse the body of grill in water or any other liquid.
3. The appliance and its cord cannot be placed in the dishwasher. The heating elements, visible and accessible parts, should not be cleaned after removing the plates. If they are very dirty, wait until the appliance has completely cooled down and clean them with a dry cloth.
4. If you do not wish to wash the cooking plates, drip trays, and baking tray in the dishwasher, use hot water and a little washing up liquid to clean, then rinse thoroughly to remove any residue. Wipe them carefully with a paper towel.  
Do not use metal scouring pads, steel wool or abrasive cleaners to clean any part of the grill, use only nylon or non-metallic cleaning pads.
5. To clean the grill cover, wipe with a warm, wet sponge and dry with a soft, dry cloth.
6. Always make sure the grill is clean and dry before storing.

Any repairs must be carried out by an approved service representative.

# Troubleshooting guide

Problem	Cause	Solution
Button <b>M</b> <b>blinking</b> +  Indicator light <b>solid blue</b> + Button <b>OK</b> <b>blinking</b>	<ul style="list-style-type: none"> <li>Switching on the appliance or starting an automatic cooking cycle with food and without plates preheating (manual mode is automatically activated).</li> </ul>	<ul style="list-style-type: none"> <li>2 possible options:               <ul style="list-style-type: none"> <li>Choose the temperature setting by pressing the <b>M</b> button and then press <b>OK</b>. Allow to cook, but you must monitor the cooking (manual mode).</li> <li>stop the appliance, remove the food, close the appliance properly, re-program the appliance and wait until end of preheating.</li> </ul> </li> </ul>
The appliance stops during the cycle of pre-heating or cooking.	<ul style="list-style-type: none"> <li>The appliance has been kept open for too long while cooking.</li> <li>The appliance has been idle too long after the end of warm up or keep warm.</li> </ul>	<ul style="list-style-type: none"> <li>Disconnect the appliance from the outlet and leave for 2-3 mins., restart the process. The next time you use the appliance, make sure you open and close it quick for best cooking results. If the problem occurs again contact your local Tefal customer service.</li> </ul>
 The indicator light <b>will blink purple</b> + Button  /  /  <b>blinking</b> + Intermittent beeping The device does not beep.	<ul style="list-style-type: none"> <li>Appliance failure.</li> <li>Appliance stored or used in a room that is too cold.</li> </ul>	<ul style="list-style-type: none"> <li>Disconnect and reconnect your appliance and immediately restart a preheat cycle. If the problem persists, contact your Customer Service.</li> </ul>
 The indicator light <b>will blink purple</b> + Button  <b>blinking</b> + Continuous beeping	<ul style="list-style-type: none"> <li>Appliance failure.</li> </ul>	<ul style="list-style-type: none"> <li>Unplug the appliance and contact customer service.</li> </ul>
After preheating, I placed the food inside and closed the appliance.  but the indicator light stays white and cooking does not begin.	<ul style="list-style-type: none"> <li>The quantity of food inside the appliance is <b>greater than 4 cm.</b></li> <li>The grill was not opened completely when placing the food inside.</li> <li>The appliance does not detect food inside <b>The quantity of food is insufficient, "OK" is blinking.</b></li> </ul>	<ul style="list-style-type: none"> <li>The quantity of food should not exceed 4 cm.</li> <li>Open the grill completely and close it again.</li> <li>Confirm cooking activation by pressing the button <b>OK</b>.</li> </ul>
The appliance will activate in manual mode +  The indicator light <b>will blink red.</b> + button <b>M</b> temp control and <b>OK</b> light fixed	<ul style="list-style-type: none"> <li>Preheating time was cut short.</li> </ul>	<ul style="list-style-type: none"> <li>Monitor the cooking periodically (for use in manual mode). Or</li> <li>Stop the grill, remove food, close the grill, select the new cooking program you wish to use and wait for the preheating cycle to finish.</li> </ul>

## INHALTSVERZEICHNIS

• Produktbeschreibung	22
• Positionen und Schnittstellen	23
• Positionsänderung	24
• Garstufen-Anzeige	25
• Vor dem ersten Gebrauch	26
• 1. Grillposition	27
a) Mit einem automatischen Programm	27
b) Im manuellen Modus	30
c) Garanleitung	31
• 2. Ofen-Position	33
• 3. Barbecue-Position	34
• 4. Position für komplette Mahlzeit	35
• Nach der Verwendung	36
• Reinigung	37
• Anleitung zur Fehlerbehebung	38

## PRODUKTBESCHREIBUNG

- A. Bedienfeld
- A1. Ein-/Aus-Taste
- A2. Funktion für tiefgekühlte Lebensmittel
- A3. 9 Automatische Garprogramme
- A4. Manueller Modus mit 4 Temperaturen
- A5. Auswahl bestätigen und Vorheizen starten
- A6. Garstufen-Anzeige
- B. Entriegelungshebel für Positionen für Barbecue und komplette Mahlzeiten
- C. Seitlicher Thermostat für Positionen für Barbecue und komplette Mahlzeiten
- D. Leuchtanzeige für Positionen für Barbecue und komplette Mahlzeiten
- E. Vordere Abtropfschale
- F. Hintere Abtropfschale
- G. Backschale
- H. Untere Platte
- I. Obere Platte
- J. Netzkabel

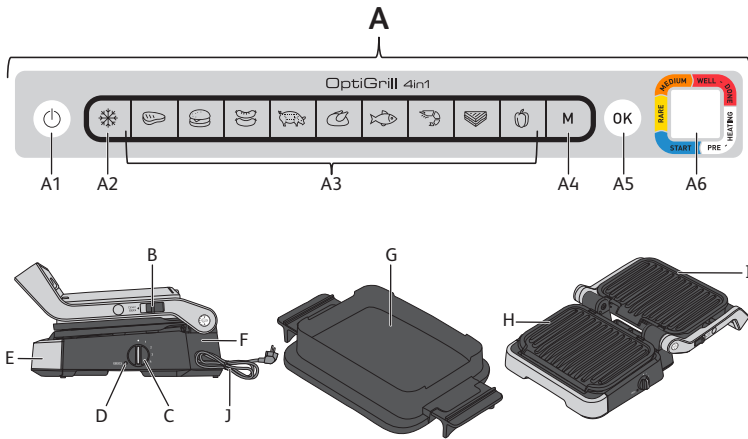

## POSITIONEN UND SCHNITTSTELLEN

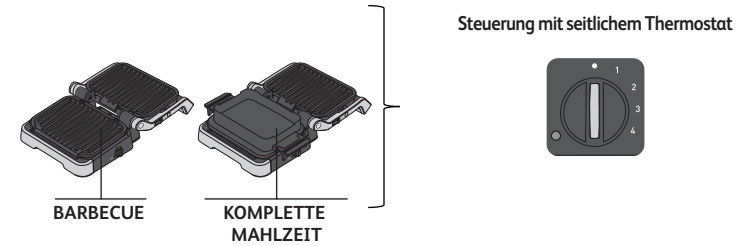
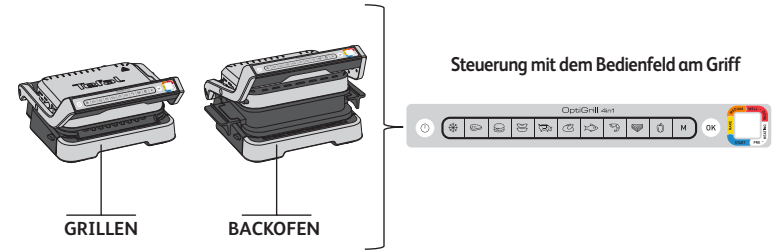

## POSITIONSÄNDERUNG

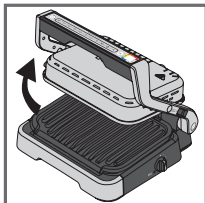

### Wechsel zur Ofen-Position:

Öffnen Sie den Grill, entfernen Sie die untere Grillplatte und ersetzen Sie sie durch die Backschale.

**Achtung:** Die Backschale wird ohne Einrasten auf den Grill gelegt.

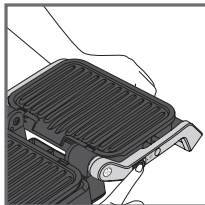
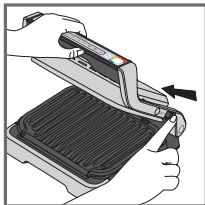

### Wechseln Sie in die Barbecue-Position:

Halten Sie beim Öffnen des Grills die Verriegelung nach oben und bringen Sie den Griff in die 180°-Barbecue-Position.

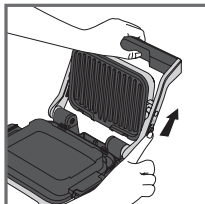
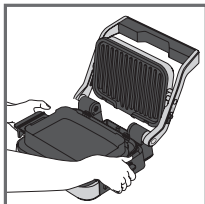

### Wechseln Sie in die Position für komplette Mahlzeit:

Setzen Sie die Backschale anstelle der unteren Platte ein und öffnen Sie dann den Grill in die 180°-Position. Befolgen Sie dabei die oben beschriebenen Schritte.

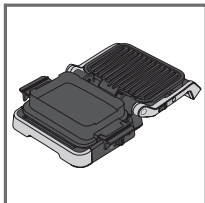

**Achtung:** Stellen Sie sicher, dass der seitliche Thermostat auf **•** steht, bevor Sie den Grill in der Barbecue-Position oder der Position für komplette Mahlzeit öffnen. Wenn der Thermostat nicht auf **•** steht, beginnt der Grill mit dem Aufheizen und benachrichtigt Sie durch einen Signalton.

## GARSTUFEN-ANZEIGE

### Vorheizen



Blinkende weiße Farbanzeige:  
Vorheizen läuft



Konstante weiße Farbanzeige und Signalton:  
bereit zum Kochen

### Kochen



Erste Garstufe läuft



Erste Garstufe erreicht



Stufe „Blutig“ läuft



Stufe „Blutig“ erreicht



Stufe „Medium“ läuft



Stufe „Medium“ erreicht



Stufe „Durchgebraten“ läuft



Stufe „Durchgebraten“ erreicht

OptiGrill informiert Sie bei jedem automatischen Programm, sobald die Speisen die gewünschte Garstufe erreicht haben. Wenn die Garstufe erreicht ist, leuchtet die Farbanzeige dauerhaft, und der Grill gibt einen Signalton aus.

## VOR DEM ERSTEN GEBRAUCH

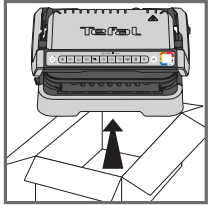

1

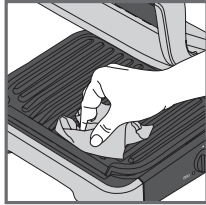

2

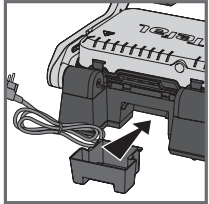

3

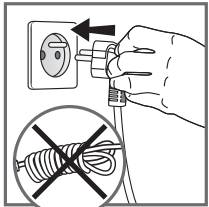
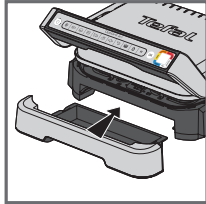

4

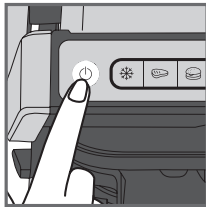

5

- Entfernen Sie sämtliches Verpackungsmaterial, Aufkleber und Zubehörteile von der Innenseite und von der Außenseite des Geräts. Zusätzliche farbige Ringaufkleber sind im Lieferumfang enthalten. Sie können Ihre bevorzugte Sprache auf den ursprünglichen Farbiring kleben.
- Reinigen Sie die Platten vor der ersten Verwendung gründlich mit warmem Wasser und etwas Spülmittel, spülen Sie die Teile ab und trocknen Sie sie gründlich ab.
- Positionieren Sie die abnehmbaren Abtropfschalen an der Vorderseite und an der Rückseite des Geräts.
- Stellen Sie sicher, dass die obere und untere Platte korrekt im Gerät positioniert sind. Aktivieren Sie die Vorheizfunktion nicht ohne die Platten. Schließen Sie das Gerät an das Stromnetz an (das Kabel muss vollständig abgewickelt sein).
- Drücken Sie die Ein-/Aus-Taste.  
**Achtung:** Stellen Sie sicher, dass sich keine Speisen zwischen den Platten befinden

## 1. GRILLPOSITION

### A) MIT EINEM AUTOMATISCHEN PROGRAMM

9 automatische Programme: Rotes Fleisch, Burger, Wurst, Schweinefleisch, Huhn, Fisch, Meeresfrüchte, Sandwich, Paprika

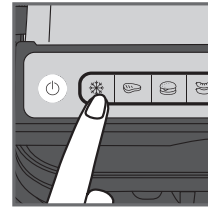

1

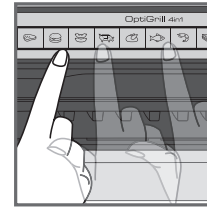

2

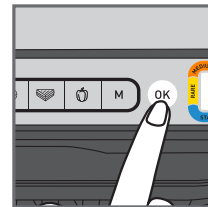

3

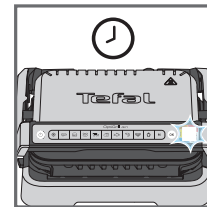

4



5

- Wenn die Lebensmittel, die Sie zubereiten möchten, gefroren sind, drücken Sie die entsprechende Taste. Diese Funktion ist nur beim Kochen mit den automatischen Programmen verfügbar, nicht im manuellen Modus.
- Wählen Sie das passende Garprogramm entsprechend der Art der Lebensmittel aus, die Sie zubereiten möchten.  
**Tipp, besonders für Fleisch:** Die Garergebnisse der Automatikprogramme können je nach Art, Teilstück und Qualität der zuzugarenden Lebensmittel variieren; die Programme wurden für Lebensmittel guter Qualität eingestellt und getestet. Auch die Dicke des Fleisches muss beim Garen berücksichtigt werden. Wir empfehlen, keine Lebensmittel mit einer Dicke von mehr als 4 cm zuzubereiten. Wenn Sie sich nicht sicher sind, welches Garprogramm Sie verwenden sollten, lesen Sie bitte die Anleitung auf Seite 31.
- Drücken Sie die Taste „OK“: Das Gerät beginnt mit dem Vorheizen, und die Garstufen-Anzeige blinkt weiß.  
**HINWEIS:** Wenn Sie das falsche Programm ausgewählt haben, schalten Sie das Gerät aus und wiederholen Sie die Schritte.
- Warten Sie, bis das Vorheizen abgeschlossen ist.
- Wenn die Garstufen-Anzeige nicht mehr weiß blinkt und der Grill Signaltöne ausgibt, ist das Vorheizen abgeschlossen, und der Grill ist bereit zum Kochen.  
**Anmerkungen:** Wenn das Gerät nach dem Vorheizen geschlossen bleibt, schaltet das Sicherheitssystem das Gerät nach einer Weile aus.

# 1. GRILLPOSITION

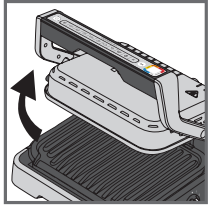

6

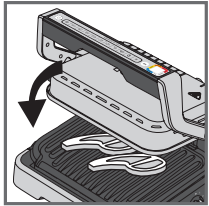
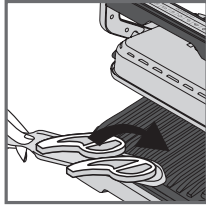

7

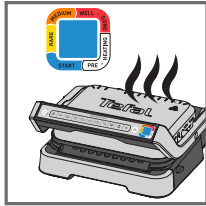

8

6. Öffnen Sie den Grill und legen Sie die Speisen auf die Grillplatte.

**Anmerkungen:** Wenn das Gerät zu lange geöffnet bleibt, schaltet das Sicherheitssystem das Gerät nach einer Weile automatisch aus.

7. Schließen Sie das Gerät, um den Garvorgang zu starten. Die Garstufen-Anzeige wird blau, um anzuzeigen, dass der Garvorgang läuft (öffnen oder bewegen Sie die Speisen während des Garvorgangs nicht, um die besten Ergebnisse zu erzielen). Das Gerät passt den Garvorgang (Zeit und Temperatur) automatisch an die Dicke und Menge der jeweiligen Lebensmittel an.

**Hinweis für sehr dünne Lebensmittel:** Schließen Sie das Gerät. Die Taste „OK“ blinkt, und die Anzeige leuchtet dauerhaft weiß, bis Sie „OK“ drücken. Drücken Sie „OK“, um sicherzustellen, dass das Gerät die Speisen erkennt und der Garvorgang beginnt.

8. Je nach Garstufe ändert die Anzeige ihre Farbe. Während des Garvorgangs wird ein Signalton ausgegeben, der Sie jedes Mal warnt, wenn eine Garstufe erreicht ist. Wenn die Anzeige zu Gelb wechselt und ein Signalton ausgegeben wird, ist das Fleisch blutig (rare), wenn sie orange leuchtet, ist es medium und wenn sie rot leuchtet, ist es durchgebraten.

**Hinweis:** Wenn Sie Ihr Fleisch noch blutiger mögen, entfernen Sie es, wenn die Anzeige für die Garstufe konstant blau leuchtet. Bitte beachten Sie, dass es normal ist, dass die Garergebnisse je nach Art, Qualität und Herkunft der Lebensmittel variieren.

# 1. GRILLPOSITION

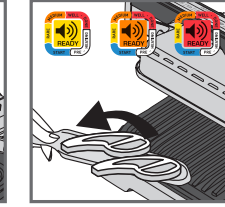

9

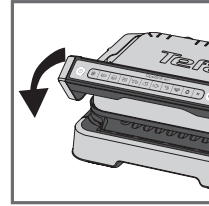

10

9. Wenn die Farbe, die der gewünschten Garstufe entspricht, konstant leuchtet und der Signalton ertönt, öffnen Sie das Gerät und entnehmen Sie Ihr Gargut.

**Hinweis:** Wenn Sie Speisen nach eigenem Geschmack zubereiten möchten, öffnen Sie den Grill, und entnehmen Sie die Speisen, wenn sie die gewünschte Garstufe erreicht haben. Schließen Sie dann den Grill und setzen Sie den Garvorgang für die anderen Speisen fort. Das Programm setzt den Garvorgang fort, bis die letzte Stufe erreicht ist.

10. Entfernen Sie nach dem Garen die Speisen und schließen Sie das Gerät. Das Bedienfeld leuchtet auf und stellt sich in den Modus „Programmwahl“.

**Kommentar:** Das Sicherheitssystem schaltet sich nach einer Weile automatisch ab, wenn kein Programm ausgewählt wird.

## Warmhaltefunktion

Wenn die rote Stufe erreicht ist, ist der Garvorgang abgeschlossen. Das Gerät aktiviert automatisch die Warmhaltefunktion, die Anzeige leuchtet rot, und das Gerät gibt alle 20 Sekunden Signalöne aus. Wenn noch Speisen auf dem Grill liegen, wird der Garvorgang fortgesetzt, während die Grillplatten abkühlen. Sie können den Signalton durch Drücken der Taste „OK“ deaktivieren.

**Hinweis:** Das Sicherheitssystem schaltet das Gerät nach einer Weile automatisch aus.

## Sofort eine zweite Portion zubereiten:

Sobald die erste Portion der Speisen fertig ist:

- Stellen Sie sicher, dass das Gerät geschlossen ist und dass sich keine Speisen mehr im Gerät befinden.
- Wählen Sie das Garprogramm aus (dieser Schritt ist auch dann erforderlich, wenn es sich um das gleiche Programm handelt wie bei den Speisen, die Sie gerade zubereitet haben).
- Drücken Sie die Taste „OK“, um mit dem Vorheizen zu beginnen. Während des Vorheizens blinkt die Farbstufenanzeige weiß.
- Sobald das Vorheizen abgeschlossen ist, gibt das Gerät einen Signalton aus, und die Anzeige leuchtet dauerhaft weiß.
- Das Gerät ist einsatzbereit, sobald das Vorheizen abgeschlossen ist. Öffnen Sie den Grill und legen Sie die Speisen in das Gerät.

## Wichtig:

- Bitte beachten Sie, dass für jede neue Portion ein Vorheizen erforderlich ist. Vergewissern Sie sich vor dem Vorheizen, dass das Gerät geschlossen ist und sich keine Speisen mehr im Gerät befinden. Warten Sie dann, bis das Vorheizen abgeschlossen ist, bevor Sie den Grill öffnen und die Speisen in den Grill legen.
- Wenn der neue Vorheizzyklus unmittelbar nach dem Ende des vorherigen Zyklus aktiviert wird, wird die Vorheizzeit verringert.

# 1. GRILLPOSITION

## B) IM MANUELLEN MODUS



1

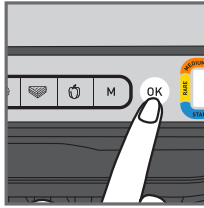

2

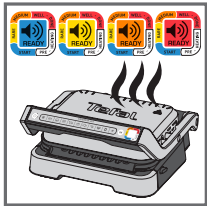

3

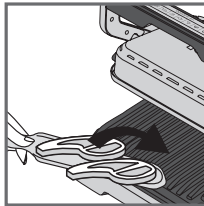

4

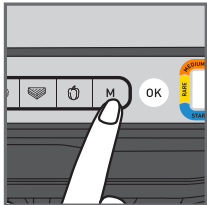

5

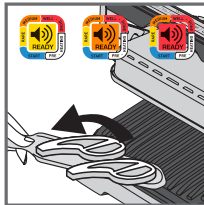

6

1. Wählen Sie den manuellen Modus und die Gartemperatur aus, indem Sie mehrmals auf „M“ klicken, bis die Farbe der gewünschten Temperatur entspricht:

	110-125°C
	180-195°C
	220-235°C
	255-275°C

2. Drücken Sie „OK“, um mit dem Vorheizen zu beginnen. Die Garstufen-Anzeige blinkt mit der ausgewählten Farbe: Vorheizen läuft. Warten Sie bis zum Ende des Vorheizvorgangs.
3. Wenn die gewünschte Temperatur erreicht ist, hört die Anzeige auf zu blinken, und der Grill gibt einen Signalton aus: Der Grill ist nun bereit zum Garen.
4. Geben Sie die Speisen auf den Grill, und der Garvorgang beginnt.
5. Sie können die Temperatur während des Garvorgangs anpassen.
6. Beobachten Sie die Speisen beim Garen, und entfernen Sie sie, sobald sie fertig sind.

# 1. GRILLPOSITION

## C) GARANLEITUNG

### 9 AUTOMATISCHE GARPROGRAMME

	GARSTUFEN-ANZEIGE			
RINDFLEISCH	Sehr blutig (Blau)	Blutig	Medium	Durchgebraten
BURGER (Frikadelle):		Blutig	Medium	Durchgebraten
WÜRSTE	-	-	-	Durchgebraten
SCHWEINEFLEISCH	-	-	-	Durchgebraten
HÄHNCHEN	-	-	-	Durchgebraten
FISCH	-	Medium	Halb durch	Durchgebraten
MEERESFRÜCHTE	-	Medium	Halb durch	Durchgebraten
SANDWICH	-	Leicht gegart	Gegrillt	Knusprig
PAPRIKA	-	-	Weich gegrillt	Gegrillt

### MANUELLER MODUS IN GRILLPOSITION

	 Von 180°C bis 195°C	 Von 220°C bis 235°C	 Von 255°C bis 275°C
KARTOFFELN			
ZUCCHINI/KÜRBIS			
AUBERGINE			
TOMATEN			
SPARGEL			
PILZE			
ZWIEBELN			
BROKKOLI			
BABYKARTOTTEN			
FENCHEL			
SÜSSKARTOFFELN			
APFELSCHNEIBEN			
ANANAS			
PFIRSICH			



## 2. OFEN-POSITION

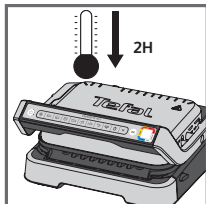

1

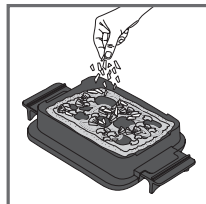

2



3

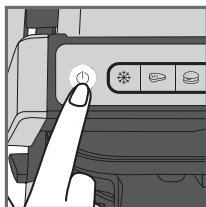
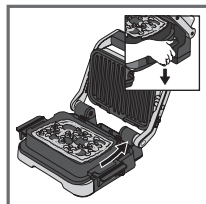

4

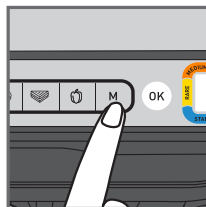

5

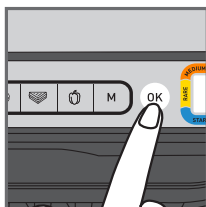

6

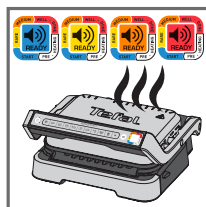

7

1. Wenn der OptiGrill bereits eingeschaltet ist und Sie die Backschale verwenden möchten, ziehen Sie den Netzstecker aus der Steckdose und lassen Sie den Grill mindestens zwei Stunden abkühlen.
2. Geben Sie die Zutaten in die Backschale.
3. Öffnen Sie den Grill, entfernen Sie die untere Grillplatte und ersetzen Sie sie durch die Backschale.  
**ACHTUNG:** Achten Sie darauf, dass die obere Grillplatte ordnungsgemäß im Gerät eingesetzt ist.
4. Schließen Sie den Grill und drücken Sie die Ein-/Aus-Taste.
5. Wählen Sie den manuellen Modus und die Gartemperatur aus, indem Sie mehrmals auf „M“ klicken, bis die Farbe der gewünschten Temperatur entspricht:

	85-110°C
	150-165°C
	190-205°C
	240-255°C

6. Beginnen Sie mit dem Vorheizen, indem Sie die Taste „OK“ drücken.
7. Wenn die gewünschte Temperatur erreicht ist, gibt der Grill einen Signalton aus, und der Garvorgang beginnt.

## 2. OFEN-POSITION

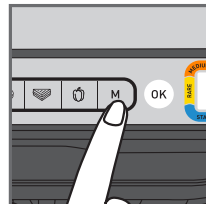

8

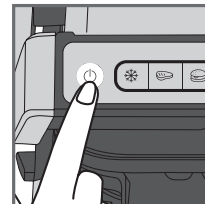

9

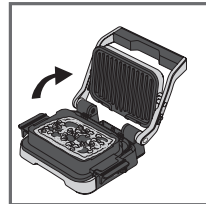

10



11

8. Sie können die Temperatur während des Garvorgangs anpassen.
9. Sehen Sie zu, wie das Essen gegart wird. Wenn Sie Ihrer Meinung nach fertig gegart ist, beenden Sie den Garvorgang, indem Sie die EIN-/AUS-Taste drücken. Alle Tasten schalten sich aus, und der Grill stoppt das Heizen/Garen.
10. Öffnen Sie den Grill und nehmen Sie die Backschale an den Griffen aus dem Grill.  
**ACHTUNG:** Bei heißen Oberflächen wird empfohlen, Handschuhe zu tragen. Die Backschale ist heiß, stellen Sie sie auf eine entsprechende Oberfläche.
11. Die Backschale ist spülmaschinengeeignet.

### 3. BARBECUE-POSITION

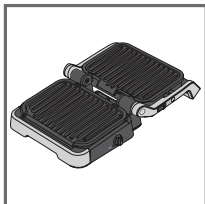

1

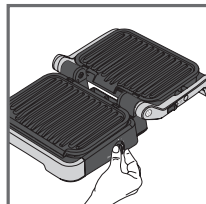

2

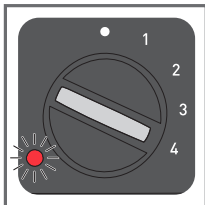

3

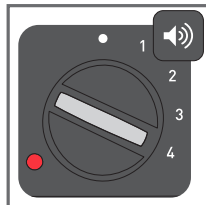

4

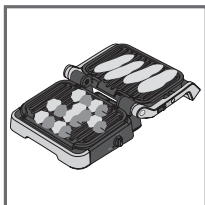

5

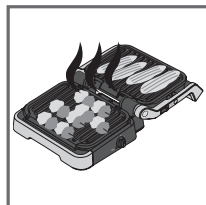

6

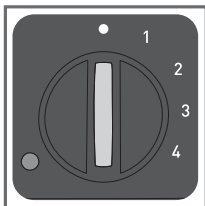

7

- Öffnen Sie den Grill in der Barbecue-Position. Der Garvorgang wird über den seitlichen Thermostat gesteuert.
- Wählen Sie die gewünschte Temperatureinstellung. Der Thermostat stellt dieselbe Gartemperatur für beide Platten ein:

• Thermostat aus
1: 80-100°C
2: 130-160°C
3: 160-190°C
4: 180-220°C

- Die seitliche Leuchtanzeige blinkt während des Vorheizens rot.
- Wenn die Leuchtanzeige dauerhaft rot leuchtet und der Grill Signaltöne ausgibt, ist der Grill einsatzbereit.
- Geben Sie Speisen auf den Grill.
- Sehen Sie zu, wie das Essen gegart wird, und entfernen Sie es, sobald es fertig ist.
- Schalten Sie das Gerät aus, indem Sie den Thermostat auf • stellen.

#### Anmerkungen:

- Sie können die Temperatur während des Garvorgangs ändern. Wird die Temperatur während des Garvorgangs geändert, stellt der Grill die Temperatur auf die neue Einstellung ein.
- Wenn Sie Speisen nur auf einer Platte zubereiten, verwenden Sie die obere Platte.

### 4. POSITION FÜR KOMPLETTE MAHLZEIT

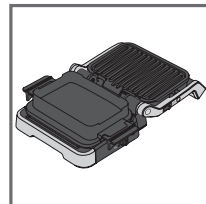

1

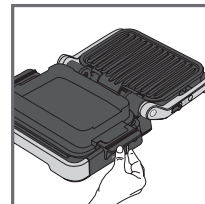

2

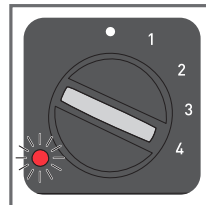

3

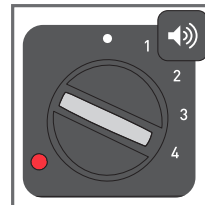

4

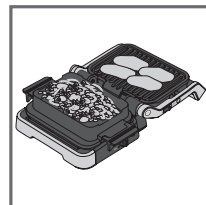

5

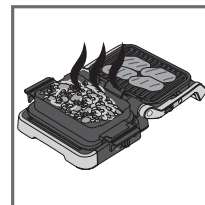

6

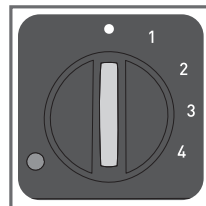

7

- Stellen Sie den Grill in die Position für komplette Mahlzeiten. Der Garvorgang wird über den seitlichen Thermostat gesteuert.
- Wählen Sie die gewünschte Temperatureinstellung. Der Thermostat steuert die Gartemperatur für beide Platten.

• Thermostat aus
1: 80-100°C
2: 130-160°C
3: 160-190°C
4: 180-220°C

- Die seitliche Leuchtanzeige blinkt während des Vorheizens rot.
- Wenn die Leuchtanzeige dauerhaft rot leuchtet und der Grill Signaltöne ausgibt, ist der Grill einsatzbereit.
- Legen Sie die Speisen auf den Grill und in die Backschale.
- Sehen Sie zu, wie das Essen gegart wird, und entfernen Sie es, sobald es fertig ist.
- Schalten Sie das Gerät aus, indem Sie den Thermostat auf • stellen.

#### Kommentar:

- Sie können die Temperatur während des Garvorgangs ändern. Wird die Temperatur während des Garvorgangs geändert, stellt der Grill die Temperatur auf die neue Einstellung ein.

#### Tips:

Wenn Sie Beilage länger zum Kochen braucht als das Grillgut, können Sie auch in der Ofen-Position mit dem Kochen beginnen. Lesen Sie hierzu bitte Seite xx und befolgen Sie die Schritte 1 bis 7. Wenn die Speisen gar sind, öffnen Sie den Grill in der Position für komplette Mahlzeit. Der Grill schaltet automatisch auf den seitlichen Thermostat. Wählen Sie mit dem Thermostat die gewünschte Temperatureinstellung aus. Wenn die Grillplatte vorgeheizt ist, legen Sie die Speisen darauf.

## NACH DER VERWENDUNG

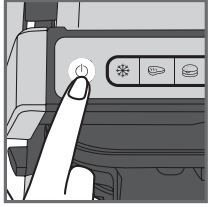

1

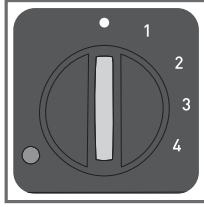

1. Schalten Sie das Gerät aus:
  - Drücken Sie die Ein-/Aus-Taste am Griff in der Grill-/Ofen-Position.
  - Stellen Sie den Seitenthermostat in der Grillpositionen/Position für komplette Mahlzeit auf •.
2. Ziehen Sie den Netzstecker des Geräts aus der Steckdose.
3. Lassen Sie das Gerät mindestens 2 Stundenlang abkühlen. Um versehentliche Verbrennungen zu vermeiden, lassen Sie den Grill vor dem Reinigen vollständig abkühlen.

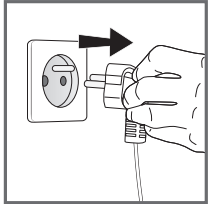

2

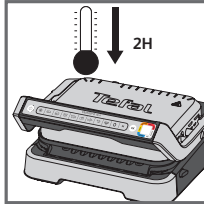

3

## REINIGUNG

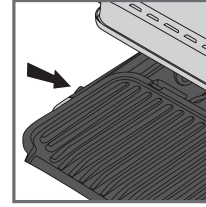

1

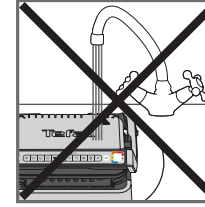

2

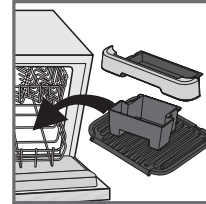

3

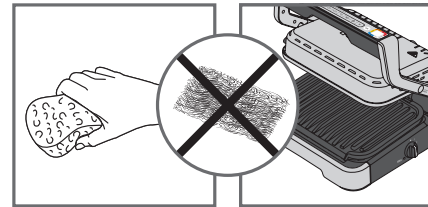

4

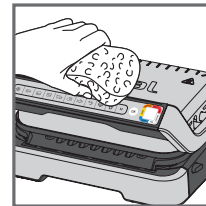

5

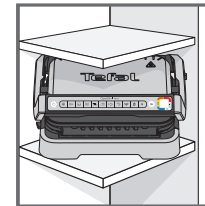





6

1. Entriegeln und entfernen Sie vor dem Reinigen die Platten, Abtropfschalen und die Backschale, um Schäden an der Kochoberfläche zu vermeiden. Leeren Sie die Abtropfschalen, waschen Sie sie mit Wasser und mildem Spülmittel, und trocknen Sie sie anschließend gründlich mit einem Papiertuch ab.
2. Tauchen Sie das Grillteil nicht in Wasser oder eine andere Flüssigkeit.
3. Das Gerät und das Kabel können nicht in die Spülmaschine gegeben werden. Die Heizelemente, sichtbare und zugängliche Teile, sollten nach dem Entfernen der Platten nicht gereinigt werden. Wenn sie sehr verschmutzt sind, warten Sie, bis das Gerät vollständig abgekühlt ist, und reinigen Sie die Heizelemente mit einem trockenen Tuch.
4. Wenn Sie die Kochplatten, Abtropfschalen und die Backschale nicht in der Spülmaschine reinigen möchten, reinigen Sie sie mit heißem Wasser und Spülmittel. Spülen Sie sie anschließend gründlich ab, um alle Rückstände zu entfernen. Wischen Sie sie vorsichtig mit einem Papiertuch ab. Verwenden Sie keine Metallscheuerschwämme, Stahlwolle oder aggressive Reinigungsmittel, um Teile des Grills zu reinigen; verwenden Sie nur Reinigungsschwämme aus Nylon oder einem anderen nichtmetallischen Material.
5. Um die Grillabdeckung zu reinigen, wischen Sie sie mit einem warmen, feuchten Schwamm ab und trocknen Sie sie mit einem weichen, trockenen Tuch ab.
6. Stellen Sie vor der Aufbewahrung sicher, dass der Grill sauber und trocken ist.

Alle Reparaturen müssen von einem zugelassenen Kundendienstvertreter durchgeführt werden.

# Anleitung zur Fehlerbehebung

Problem	Cause	Solution
Taste <b>M</b> blinkt + Anzeige leuchtet permanent blau + Taste <b>OK</b> blinkend	<ul style="list-style-type: none"> <li>Einschalten des Gerätes oder Starten eines automatischen Garvorgangs mit Grillgut ohne Aufheizen der Platten (manueller Modus wird automatisch aktiviert.)</li> </ul>	<ul style="list-style-type: none"> <li>2 Möglichkeiten:                             <ul style="list-style-type: none"> <li>Wählen Sie die Temperatur, indem Sie zuerst die Taste <b>M</b> und dann „<b>OK</b>“ drücken. Garen lassen und dabei Garvorgang überwachen (da das Gerät im manuellen Modus betrieben wird).</li> <li>Schalten Sie das Gerät aus, nehmen Sie das Grillgut aus dem Gerät, schließen Sie das Gerät ordnungsgemäß, stellen Sie das Programm neu ein und warten Sie das Ende des Aufheizvorgangs ab.</li> </ul> </li> </ul>
Das Gerät schaltet sich während des Aufheiz- oder Garvorgangs von alleine aus.	<ul style="list-style-type: none"> <li>Das Gerät war während des Garens zu lange geöffnet.</li> <li>Das Gerät war nach dem Aufheizvorgang oder dem Warmhaltevorgang zu lange nicht in Betrieb.</li> </ul>	<ul style="list-style-type: none"> <li>Ziehen Sie den Netzstecker, warten Sie 2 bis 3 Minuten und starten Sie den Vorgang neu. Bei der nächsten Nutzung darauf achten, dass Sie das Gerät schnell öffnen und schließen, um bestmögliche Gar-Resultate zu erhalten. Wenn das Problem erneut auftritt, kontaktieren Sie ihren Tefal-Kundendienst vor Ort.</li> </ul>
Anzeige lila blinkend + Taste  /  /  /  blinkend + Aussetzender Piepton	<ul style="list-style-type: none"> <li>Ausfall des Geräts.</li> <li>Produkt blockiert oder in zu kalter Umgebung verwendet.</li> </ul>	<ul style="list-style-type: none"> <li>Ziehen Sie den Netzstecker, schließen Sie das Gerät direkt wieder an und starten Sie im Aufheizvorgang. Wenn sich das Problem nicht beheben lässt, wenden Sie sich an einen autorisierten Kundendienst.</li> </ul>
Das Gerät gibt keine akustischen Signale mehr aus.		
Anzeige lila blinkend + Taste  blinkend + Anhaltender Signalton	<ul style="list-style-type: none"> <li>Gerätefehler</li> </ul>	<ul style="list-style-type: none"> <li>Ziehen Sie den Stecker des Geräts und wenden Sie sich an den Kundendienst.</li> </ul>
Nach dem Aufheizen habe ich das Grillgut hineingelegt und das Gerät geschlossen, die Anzeige bleibt weiß und der Garvorgang startet nicht.	<ul style="list-style-type: none"> <li>Ihr Grillgut ist dicker als 4 cm.</li> <li>Sie haben den Grill nicht vollständig geöffnet, um das Grillgut hineinzulegen.</li> <li>Grillgut nicht erkannt</li> </ul>	<ul style="list-style-type: none"> <li>Die Dicke des Grillguts darf 4 cm nicht übersteigen.</li> <li>Öffnen Sie den Grill vollständig und schließen Sie ihn anschließend wieder.</li> <li>Bestätigen Sie den Start des Garvorgangs, indem Sie die Taste <b>OK</b> drücken.</li> </ul>
Das Gerät wechselt in den manuellen Modus + Anzeige Rot blinkend + Taste <b>M</b> Temperaturkontrolle und leuchtet permanent.	<ul style="list-style-type: none"> <li>Die Aufheizzeit ist noch nicht abgelaufen.</li> </ul>	<ul style="list-style-type: none"> <li>Garen lassen und dabei Garvorgang überwachen (da das Gerät im manuellen Modus betrieben wird) oder</li> <li>Grill ausschalten, Grillgut aus dem Gerät nehmen, Grill schließen, das gewünschte Programm erneut wählen und Ende des Aufheizvorgangs abwarten.</li> </ul>

## INHOUDSOPGAVE

• Productbeschrijving	40
• Standen en interfaces	41
• Wijziging van stand	42
• Indicator voor garingsniveau	43
• Voor het eerste gebruik	44
• 1. De stand Grillen	45
a) Een automatisch programma gebruiken	45
b) De handmatige modus gebruiken	48
c) Kookgids	49
• 2. De ovenstand	50
• 3. De stand Barbecueën	52
• 4. De stand Volledige maaltijd	53
• Aan het eind van het gebruik	54
• Reiniging	55
• Probleemoplossingsgids	56

## PRODUCTBESCHRIJVING

- A. Bedieningspaneel
- A1. Aan/Uit-knop
- A2. Functie voor bevroren voedsel
- A3. 9 Automatische kookprogramma's
- A4. Handmatige modus met 4 temperaturen
- A5. Bevestig de selectie en start het voorverwarmen
- A6. Indicator voor garingsniveau
- B. Ontgrendeling voor de standen Barbecueën en Volledige maaltijd
- C. Thermostaat aan de zijkant van de standen Barbecueën en Volledige maaltijd
- D. Indicatielampje voor de standen Barbecueën en Volledige maaltijd
- E. Lekbak aan voorzijde
- F. Lekbak aan achterzijde
- G. Bakplaat
- H. Onderplaat
- I. Bovenplaat
- J. Netsnoer

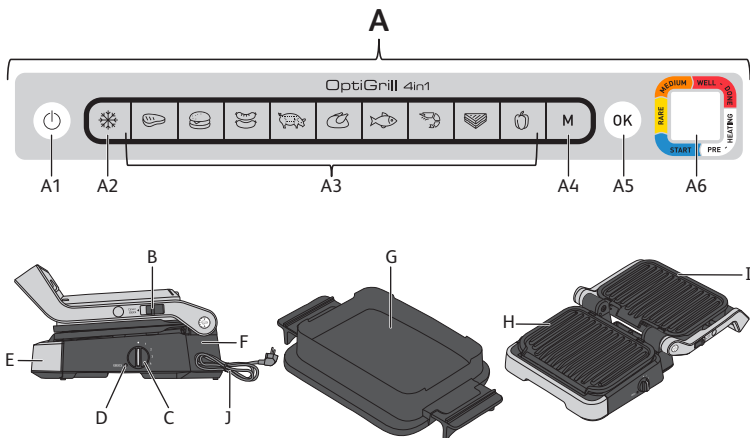

## STANDEN EN INTERFACES

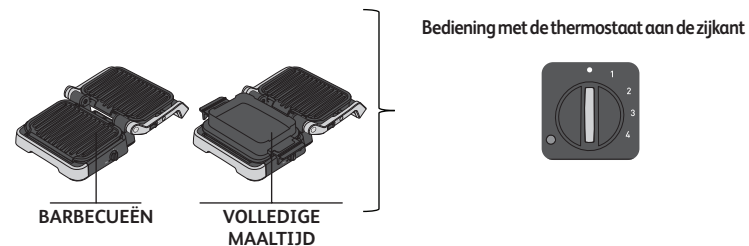
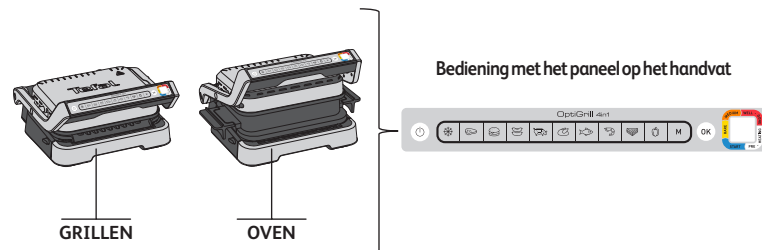

## WIJZIGING VAN STAND

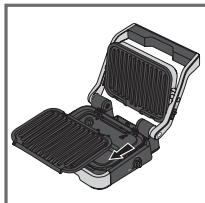
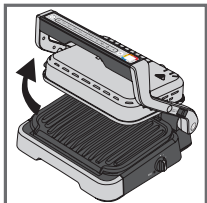

### Overschakelen naar de ovenstand:

Open de grill, verwijder de onderste grillplaat en vervang deze door de bakplaat.

**Let op:** De bakplaat kan boven op de grill worden geplaatst zonder die vast te zetten.

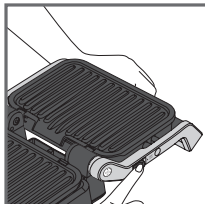
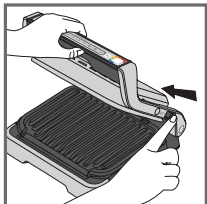

### Overschakelen naar de stand Barbecueën:

Houd bij het openen van de grill de vergrendeling omhoog en zet de hendel in de stand Barbecueën 180° geopend.

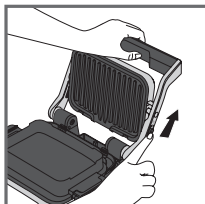
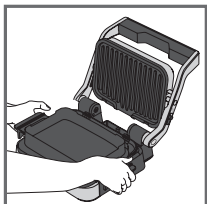

### Overschakelen naar de stand Volledige maaltijd:

Schuif de bakplaat op de plaats van de onderste plaat en open de grill vervolgens in de 180°-stand volgens bovenstaande stappen.

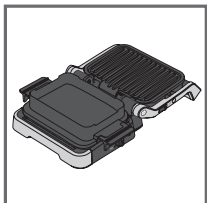

**Let op:** Controleer of de thermostaat aan de zijkant is ingesteld op • voordat u de grill in de stand Barbecueën of Volledige maaltijd opent. Als de thermostaat niet is ingesteld op •, begint de grill op te warmen en hoort u een piepgeluid.

## INDICATOR VOOR GARINGSNIVEAU

### Voorverwarmen



>



Knipperend witgekleurd lampje: bezig met voorverwarmen

Continu witgekleurd lampje en piepgeluid: klaar om te worden bereid

### Bereiden



Eerste garingsniveau in uitvoering

Eerste garingsniveau bereikt

Niveau "Rare" in uitvoering

Niveau "Rare" bereikt

Niveau "Medium rare" in uitvoering

Niveau "Medium rare" bereikt

Niveau "Well done" in uitvoering

Niveau "Well done" bereikt

Voor elk automatisch programma laat OptiGrill u weten wanneer uw voedsel het gewenste garingsniveau heeft bereikt. Wanneer een garingsniveau is bereikt, blijft de kleurindicator branden en piept de grill om u te waarschuwen.

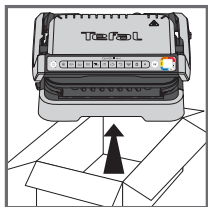

1

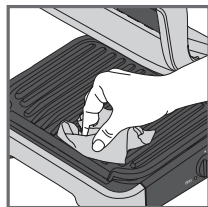

2

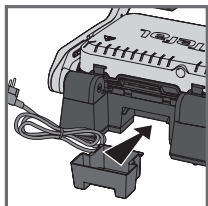

3

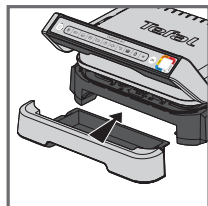

4

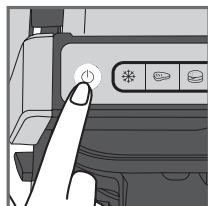

5

1. Verwijder al het verpakkingsmateriaal, stickers en accessoires aan de binnen- en buitenkant van het apparaat. Er worden extra gekleurde ringstickers meegeleverd. U kunt de taal van uw voorkeur op de ring met de oorspronkelijke kleur plakken.
2. Maak de platen grondig schoon met warm water en een beetje afwasmiddel voordat u ze voor de eerste keer gebruikt. Spoel de platen schoon en droog ze grondig af.
3. Plaats de verwijderbare lekbakken aan de voor- en achterzijde van het apparaat.
4. Zorg ervoor dat de bovenste en onderste platen correct in het product zijn geplaatst. Schakel het voorverwarmen niet in zonder de platen. Sluit het apparaat aan op het stopcontact (het snoer moet volledig worden afgewikkeld).
5. Druk op de aan/uit-knop.  
**Let op:** Zorg ervoor dat er geen voedsel tussen de platen zit

### A) EEN AUTOMATISCH PROGRAMMA GEBRUIKEN

9 automatische programma's: rood vlees, hamburger, worst, varkensvlees, kip, vis, zeevruchten, sandwich, pepers

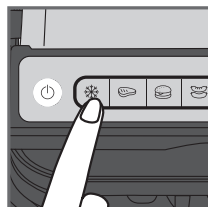

1

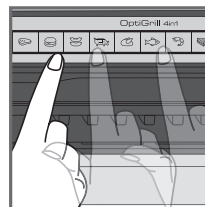

2

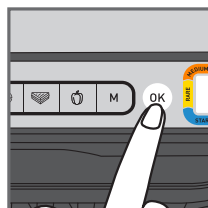

3

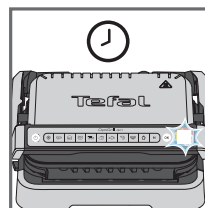

4

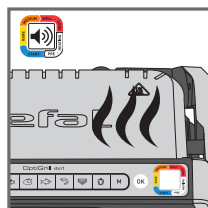

5

1. Als het voedsel dat u wilt bereiden bevroren is, drukt u op de bijbehorende knop. Deze functie is alleen beschikbaar wanneer u met de automatische programma's kookt, niet in de handmatige modus.
2. Selecteer het juiste kookprogramma op basis van het soort voedsel dat u wilt bereiden.

**Tip, met name voor vlees:** De bereidingsresultaten van de automatische programma's kunnen variëren, afhankelijk van de herkomst, het snijden en de kwaliteit van het voedsel dat wordt bereid. De programma's zijn ingesteld en getest op voedsel van goede kwaliteit. Houd ook rekening met de dikte van het vlees tijdens het bereiden; bereid geen voedsel met een dikte van meer dan 4 cm. Als u niet zeker weet welk kookprogramma u moet gebruiken, raadpleegt u de kookgids op pagina 49.

3. Druk op de knop **OK**; het apparaat begint met voorverwarmen en de indicator voor garingsniveau knippert wit.
- NB:** Als u het verkeerde programma hebt gekozen, schakelt u het apparaat uit en herhaalt u de stappen.
4. Wacht tot het voorverwarmen is voltooid.
5. Wanneer de niveau-indicator stopt met wit knipperen en de grill piept, is het voorverwarmen voltooid en is de grill klaar om te worden gebruikt.

**Opmerkingen:** Als het apparaat na het voorverwarmen gesloten blijft, schakelt het veiligheidssysteem het apparaat na enige tijd uit.

## 1. DE STAND GRILLEN

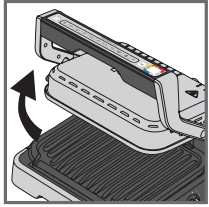

6

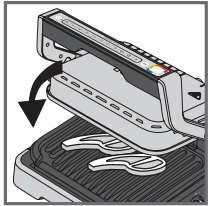
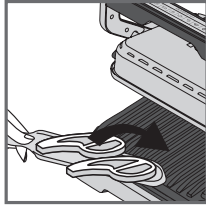

7

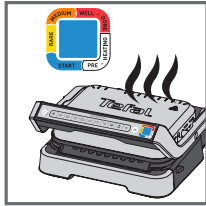

8

6. Open de grill en plaats de etenswaren op de bakplaat.

**Opmerkingen:** Als het apparaat te lang open blijft, zal het beveiligingssysteem het apparaat automatisch na enige tijd uitschakelen.

7. Sluit het apparaat om de bakcyclus te starten. De indicator voor garingsniveau wordt blauw om aan te geven dat de bereiding wordt uitgevoerd (open of verplaat uw voedsel niet tijdens het bakproces voor het beste resultaat).

Het apparaat past de bakcyclus (tijd en temperatuur) automatisch aan afhankelijk van de dikte en hoeveelheid van het voedsel.

**Opmerking voor zeer dunne stukken voedsel:** Sluit het apparaat. De knop **OK** knippert en de indicator blijft wit branden totdat u op **OK** drukt. Druk op **OK** om ervoor te zorgen dat het apparaat het voedsel herkent en de bakcyclus start.

8. Afhankelijk van het garingsniveau verandert het indicatielampje van kleur. Tijdens het bakken hoort u een pieptoon telkens wanneer een garingsniveau wordt bereikt. Wanneer het indicatielampje geel met een pieptoon is, is het voedsel rare, wanneer het oranje met een pieptoon is, is het voedsel medium en wanneer het rood met een pieptoon is, is het voedsel well-done.

**Opmerking:** Als u van very rare vlees houdt, verwijder dan het vlees wanneer de indicator voor garingsniveau onafgebroken blauw brandt.

Let op: vooral bij vlees is het normaal dat de garingsresultaten variëren afhankelijk van het type, de kwaliteit en de herkomst van het voedsel.

## 1. DE STAND GRILLEN



9

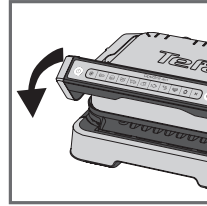
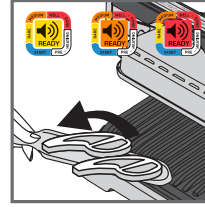

10

9. Wanneer de kleur die overeenkomt met het gewenste garingsniveau constant wordt en u een pieptoon hoort, opent u het apparaat en haalt u het voedsel eruit.

**Opmerking:** Als u voedsel voor verschillende persoonlijke smaken wilt bereiden, opent u de grill en verwijdert u het voedsel wanneer het gewenste niveau is bereikt. Sluit vervolgens de grill en ga verder met het bereiden van het andere eten. Het programma gaat door met de bakcyclus tot het uiteindelijke niveau is bereikt.

10. Als u klaar bent met bakken, verwijdert u het voedsel en sluit u het apparaat. Het bedieningspaneel licht op en stelt zichzelf in op de modus 'programma kiezen'.

**Opmerkingen:** Het beveiligingssysteem wordt na enige tijd automatisch uitgeschakeld als er geen programma wordt geselecteerd.

### Warmhoudfunctie

Zodra het rode niveau is bereikt, is het bereiden voltooid, activeert het apparaat automatisch de warmhoudfunctie, brandt het indicatielampje rood en begint het apparaat elke 20 seconden te piepen. Als er voedsel op de grill achterblijft, blijft het bakken terwijl de bakplaten afkoelen. U kunt de pieptoon deactiveren door op de knop **OK** te drukken.

**Opmerking:** Het beveiligingssysteem schakelt het apparaat na een tijdje automatisch uit.

### Direct een tweede portie bereiden:

Zodra uw eerste portie voedsel klaar is met bakken:

- Zorg ervoor dat het apparaat gesloten is en dat er geen voedsel in zit.
- Selecteer het bakprogramma (deze stap is nodig, zelfs als het programma hetzelfde is als voor het voedsel dat u zojuist hebt bereid)
- Druk op de knop **OK** om het voorverwarmen te starten. Tijdens het voorverwarmen knippert de indicator voor garingsniveau wit.
- Zodra het voorverwarmen is voltooid, piept het apparaat en brandt het indicatielampje wit.
- Het apparaat is klaar voor gebruik zodra het voorverwarmen is voltooid. Open de grill en plaats de etenswaren in het apparaat.

### Belangrijk:

- Houd er rekening mee dat voor elke nieuwe portie voorverwarmen nodig is. Zorg ervoor dat het apparaat is gesloten en dat er geen voedsel in zit voordat u het apparaat voorverwarmt. Wacht tot het voorverwarmen is voltooid voordat u de grill opent en er etenswaren in doet.
- Als de nieuwe voorverwarmingscyclus onmiddellijk na het einde van de vorige cyclus wordt geactiveerd, wordt de voorverwarmingstijd verkort.



# 1. DE STAND GRILLEN

## B) DE HANDMATIGE MODUS GEBRUIKEN

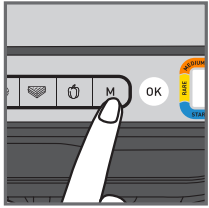

1

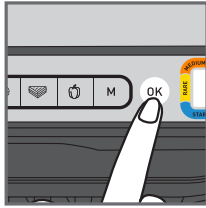

2

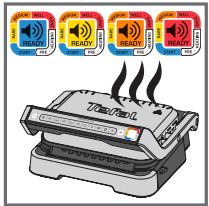

3

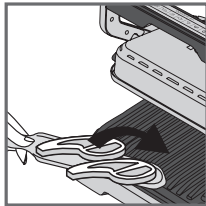

4

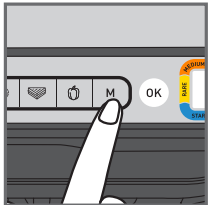

5

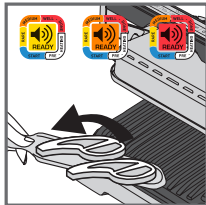

6

1. Selecteer de handmatige modus en de bereidingstemperatuur door meerdere keren op M te klikken totdat de kleur overeenkomt met de gewenste temperatuur:

	110-125°C
	180-195°C
	220-235°C
	255-275°C

2. Druk op OK om te beginnen met voorverwarmen. De indicator voor garingsniveau knippert met de gekozen kleur: het apparaat wordt voorverwarmd. Wacht tot het voorverwarmen is voltooid.
3. Wanneer de gewenste temperatuur is bereikt, stopt het lampje met knipperen en piept de grill: de grill is klaar om te worden gebruikt.
4. Doe de etenswaren in de grill. Het bakproces begint.
5. U kunt de temperatuur tijdens het bakken aanpassen.
6. Kijk hoe het voedsel bakt en verwijder het wanneer u het naar wens is.

# 1. DE STAND GRILLEN

## C) KOOKGIDS

### 9 AUTOMATISCHE KOOKPROGRAMMA'S

	INDICATEUR DU NIVEAU DE CUISSON			
RUNDVLEES:	Erg rauw van binnen (blauw)	Rauw van binnen	Medium	Doorbakken
HAMBURGER	-	Rauw	Medium	Doorbakken
WORSTJES	-	-	-	Doorbakken
VARKENSVLEES:	-	-	-	Doorbakken
KIP	-	-	-	Doorbakken
VIS	-	Medium	Medium/Doorbakken	Doorbakken
ZEEVRUCHTEN	-	Medium	Medium/Doorbakken	Doorbakken
SANDWICH	-	Licht gaar	Gegrild	Knapperig
PEPERS	-	-	Licht gegrild	Gegrild

### HANDMATIGE MODUS IN DE STAND GRILLEN

	Van 180°C tot 195°C	Van 220°C tot 235°C	Van 255°C tot 275°C
AARDAPPELEN			
COURGETTE/POMPOEN			
AUBERGINE			
TOMAAT			
ASPERGES			
PADDENSTOELEN			
UI			
BROCCOLI			
MINI-WORTELEN			
VENKEL			
ZOETE AARDAPPELEN			
APPEL (SCHIJFJES)			
ANANAS			
PERZIK			

## 2. DE OVENSTAND

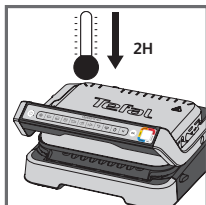

1



2



3

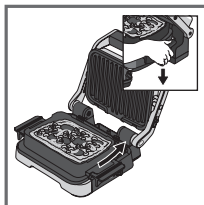

4

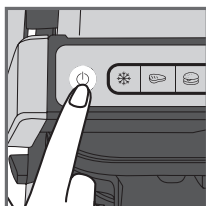

5

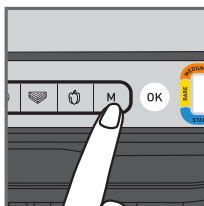

6

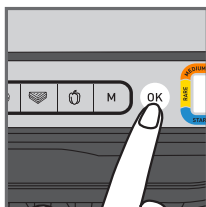



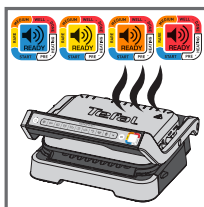

7



8

- Als uw OptiGrill al is ingeschakeld en u de bakplaat wilt gebruiken, haal dan de stekker uit het stopcontact en laat de grill ten minste 2 uur afkoelen.
  - Leg de ingrediënten op de bakplaat.
  - Open de grill, verwijder de onderste grillplaat en vervang deze door de bakplaat.
- LET OP:** Zorg ervoor dat de bovenste grillplaat goed in het apparaat is geplaatst.
- Sluit de grill en druk op de aan/uit-knop.
  - Selecteer de handmatige modus en de bereidingstemperatuur door meerdere keren op M te klikken totdat de kleur overeenkomt met de gewenste temperatuur:

	85-110°C
	150-165°C
	190-205°C
	240-255°C

- Begin met voorverwarmen door op de knop OK te drukken.
- Wanneer de gewenste temperatuur is bereikt, piept de grill en begint het bakproces.

## 2. DE OVENSTAND

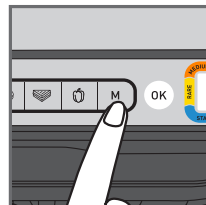

8

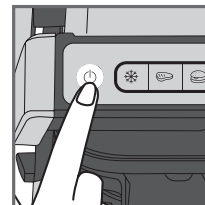

9

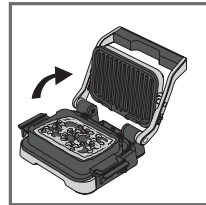

10



11

- U kunt de temperatuur tijdens het bakken aanpassen.
  - Kijk hoe het voedsel wordt gebakken. Als u het gerecht naar wens wilt koken, kunt u het koken beëindigen door op de aan/uit-knop te drukken. Alle knoppen worden uitgeschakeld, de grill stopt met verwarmen/bakken.
  - Open de grill en verwijder de bakplaat van de grill met de handvaten.
- LET OP:** Hete oppervlakken, het gebruik van handschoenen wordt aanbevolen. De bakplaat is heet. Plaats deze op een geschikt oppervlak.
- De bakplaat kan in de vaatwasmachine.

### 3. DE STAND BARBECUEËN

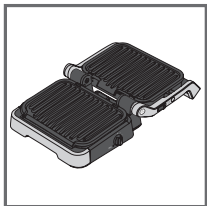

1

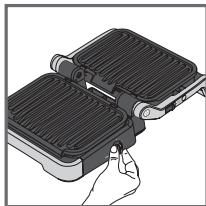

2

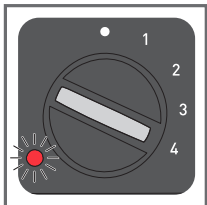

3

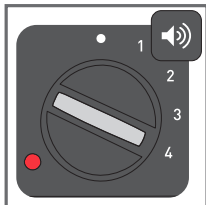

4

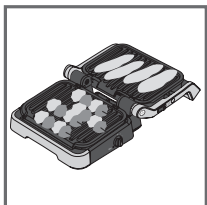

5

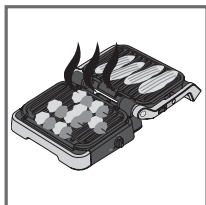

6

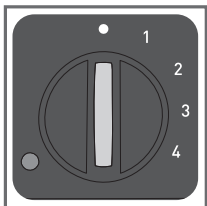

7

1. Open de grill in de stand Barbecueën. Het bakken wordt geregeld met de thermostaat aan de zijkant.
2. Selecteer de gewenste temperatuurinstelling. De thermostaat stelt voor beide platen dezelfde bereidingstemperatuur in:

• **thermostaat uitgeschakeld**

1: 80-100°C

2: 130-160°C

3: 160-190°C

4: 180-220°C

3. Het zij-indicatielampje knippert rood tijdens het voorverwarmen.
4. Wanneer het indicatielampje rood blijft branden en de grill piept, is de grill klaar voor gebruik.
5. Doe de etenswaren in de grill.
6. Kijk hoe het voedsel wordt bereid en verwijder het zodra het gaar is.
7. Schakel het apparaat uit door de thermostaat in te stellen op •.

**Opmerkingen:**

- U kunt de temperatuur tijdens het bereiden wijzigen. Als deze tijdens de bereiding wordt gewijzigd, stelt de grill de temperatuur in op de nieuwe stand.
- Als u voedsel alleen op één plaat bereidt, gebruik dan de bovenste.

### 4. DE STAND VOLLEDIGE MAALTIJD

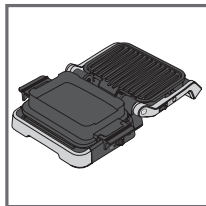

1

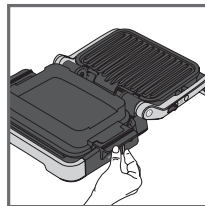

2

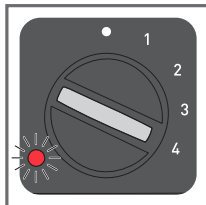

3

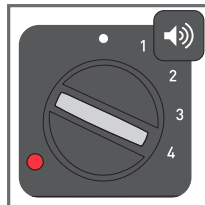

4

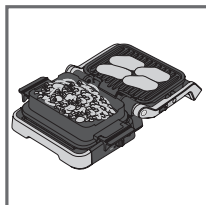

5



6

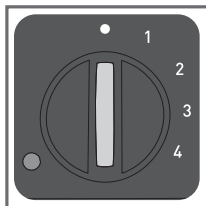

7

1. Zet de grill in de stand Volledige maaltijd. Het bakken wordt geregeld met de thermostaat aan de zijkant.
2. Selecteer de gewenste temperatuurinstelling. De thermostaat regelt de bereidingstemperatuur voor beide platen.

• **thermostaat uitgeschakeld**

1: 80-100°C

2: 130-160°C

3: 160-190°C

4: 180-220°C

3. Het zij-indicatielampje knippert rood tijdens het voorverwarmen.
4. Wanneer het indicatielampje rood blijft branden en de grill piept, is de grill klaar voor gebruik.
5. Leg de etenswaren op de grill en op de bakplaat.
6. Kijk hoe het voedsel wordt bereid en verwijder het zodra het gaar is.
7. Schakel het apparaat uit door de thermostaat in te stellen op •.

**Opmerkingen:**

- U kunt de temperatuur tijdens het bereiden wijzigen. Als deze tijdens de bereiding wordt gewijzigd, stelt de grill de temperatuur in op de nieuwe stand.

**Tips:**

Als het langer duurt om uw bijgerecht te bereiden dan de etenswaren die u aan het grillen bent, kunt u ook in de ovenstand beginnen. Als u dit doet, raadpleegt u pagina xx en volgt u de stappen 1 t/m 7. Open de grill in de stand Volledige maaltijd wanneer het voedsel naar wens is bereid. De grill schakelt automatisch over naar de thermostaat aan de zijkant. Kies de gewenste temperatuurinstelling met behulp van de thermostaat. Wanneer de grillplaat is voorverwarmd, legt u de etenswaren erop.

## AAN HET EIND VAN HET GEBRUIK

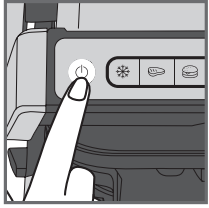

1

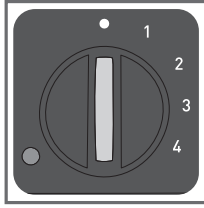

- Het apparaat uitschakelen:
  - Druk in de grill-/ovenstand op de aan/uit-knop op het handvat.
  - Stel de thermostaat aan de zijkant in op de stand Barbecueën/Volledige maaltijd.
- Haal de stekker van het apparaat uit het stopcontact.
- Laat het apparaat ten minste 2 uur afkoelen. Laat de grill goed afkoelen voordat u deze schoonmaakt om brandwonden te voorkomen.

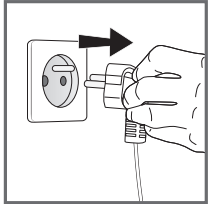

2

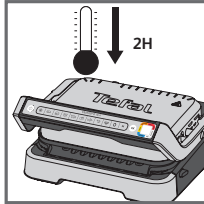

3

## REINIGING

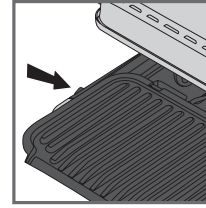

1

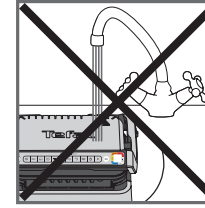

2

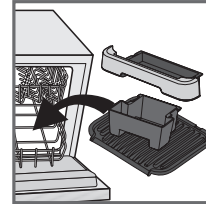

3

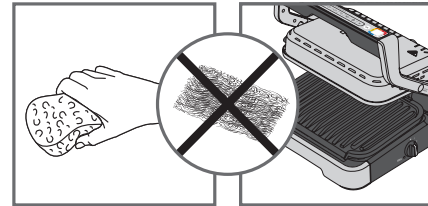

4

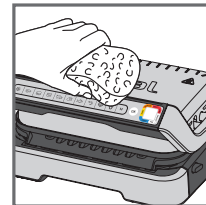

5

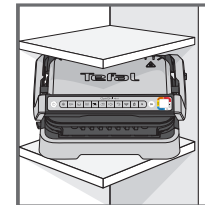

6

- Ontgrendel en verwijder de platen, lekbakken en bakplaat voordat u ze schoonmaakt om schade aan het bakoppervlak te voorkomen. Laat de lekbakken leeglopen, was ze in water met een mild sopje en droog ze grondig met keukenpapier.
- Dompel de behuizing van de grill nooit onder in water of een andere vloeistof.
- Het apparaat en het snoer kunnen niet in de vaatwasmachine. De verwarmingselementen, zichtbare en toegankelijke onderdelen, mogen niet worden gereinigd nadat de platen zijn verwijderd. Als deze erg vuil zijn, wacht dan tot het apparaat volledig is afgekoeld en maak ze schoon met een droge doek.
- Als u de kookplaten, lekbakken en bakschaal niet in de vaatwasmachine wilt wassen, gebruik dan warm water en een beetje afwasmiddel om deze schoon te maken. Spoel ze vervolgens grondig af om eventuele resten te verwijderen. Veeg ze voorzichtig droog met keukenpapier. Maak geen enkel onderdeel van de grill schoon met een metalen schuursponsje, staalwol of een agressief schoonmaakmiddel. Gebruik alleen een nylon of niet-metalen schoonmaakspons.
- Maak de grillhoes schoon door deze af te vegen met een warme, natte spons en te drogen met een zachte, droge doek.
- Zorg er altijd voor dat de grill schoon en droog is voordat u deze opbergt.

Alle reparaties moeten worden uitgevoerd door een erkende servicevertegenwoordiger.

# Probleemoplossingsgids

Probleem	Oorzaak	Oplossing
Knop  knippert + Gaarheidsindicator is continu blauw + Knipperende  toets	<ul style="list-style-type: none"> <li>Het apparaat inschakelen of een automatisch kookprogramma starten met eten en zonder het voorverwarmen van de platen (manuele modus is automatisch geactiveerd).</li> </ul>	<ul style="list-style-type: none"> <li>2 mogelijkheden:                             <ul style="list-style-type: none"> <li>Kies de temperatuur door op  te drukken en vervolgens op 'OK'. Laat alles garen en houd toezicht op de bereiding (want handmatige stand).</li> <li>Schakel het apparaat uit, verwijder het voedsel, sluit het apparaat op de correcte manier, herprogrammeer het apparaat en wacht tot het klaar is met voorverwarmen.</li> </ul> </li> </ul>
Het apparaat stopt vanzelf tijdens het voorverwarmen of bakken.	<ul style="list-style-type: none"> <li>Het apparaat is tijdens het bakken te lang open blijven staan.</li> <li>Het apparaat bleef te lang inactief na het einde van de voorverwarming of het warmhoud proces.</li> </ul>	<ul style="list-style-type: none"> <li>Trek de stekker uit het stopcontact, wacht 2 tot 3 minuten en start het proces opnieuw op. Let er de volgende keer dat u het apparaat gebruikt op dat u het snel opent en sluit, om zó de beste bakresultaten te verkrijgen. Neem contact op met de klantenservice van Tefal als het probleem zich nog eens voordoet.</li> </ul>
Knipperend paars lichtje + knipperende  /  /  /  toets + onderbroken piep	<ul style="list-style-type: none"> <li>Defect van het apparaat</li> <li>Product bewaard of gebruikt in een te koude ruimte.</li> </ul>	<ul style="list-style-type: none"> <li>Trek de stekker uit het stopcontact, steek de stekker er meteen weer in en start een voorverwarmingscyclus op. Contacteer de klantenservice als het probleem aanhoudt.</li> </ul>
Het apparaat laat geen geluidssignaal meer horen.		
Knipperend paars lampje + Knipperende  toets + permanent geluidssignaal	<ul style="list-style-type: none"> <li>Defect van het apparaat</li> </ul>	<ul style="list-style-type: none"> <li>Trek de stekker uit het stopcontact en contacteer de klantenservice.</li> </ul>
Na het voorverwarmen heb ik het voedsel tussen de platen gelegd en het apparaat gesloten,  maar het lampje blijft wit en de bereiding start niet.	<ul style="list-style-type: none"> <li>Uw voedsel is dikker dan 4 cm.</li> <li>U hebt de grill niet helemaal geopend om de voeding te plaatsen.</li> <li>Voedsel niet gedetecteerd <b>Het voedsel is te dun, OK-toets knippert.</b></li> </ul>	<ul style="list-style-type: none"> <li>Het voedsel mag niet dikker zijn dan 4 cm.</li> <li>Open de grill volledig en sluit dan weer.</li> <li>Bevestig het begin van de bereiding met een druk op de toets .</li> </ul>
Het apparaat gaat over op handmatige stand. +  Knipperend rood lampje + knop  temperatuurcontrole en  lampje is continu aan	<ul style="list-style-type: none"> <li>De voorverwarmingstijd is nog niet afgelopen.</li> </ul>	<ul style="list-style-type: none"> <li>Laat alles garen en houd toezicht op de bereiding (want handmatige stand). Of</li> <li>Schakel de grill uit, verwijder het voedsel, sluit de grill, kies opnieuw het gewenste programma en wacht tot het klaar is met voorverwarmen.</li> </ul>

## TABLE DES MATIÈRES

• Description du produit	58
• Positions et interfaces	59
• Changement de position	60
• Indicateur du niveau de cuisson	61
• Avant la première utilisation	62
• 1. Position grill	63
a) Utilisation d'un programme automatique	63
b) Utilisation du mode manuel	66
c) Guide de cuisson	67
• 2. Position four	68
• 3. Position barbecue	70
• 4. Position repas complet	71
• Fin de cuisson	72
• Nettoyage	73
• Guide de dépannage	74

## DESCRIPTION DU PRODUIT

- A. Tableau de commande
- A1. Marche/Arrêt
- A2. Fonction aliment congelé
- A3. 9 programmes automatiques
- A4. Mode manuel 4 températures
- A5. Validation du choix et démarrage du préchauffage
- A6. Indicateur du niveau de cuisson
- B. Loquet de déverrouillage pour positions barbecue & repas complet
- C. Thermostat latéral pour positions barbecue & repas complet
- D. Voyant de contrôle pour positions barbecue & repas complet
- E. Bac à jus avant
- F. Bac à jus arrière
- G. Accessoire four
- H. Plaque inférieure
- I. Plaque supérieure
- J. Cordon d'alimentation

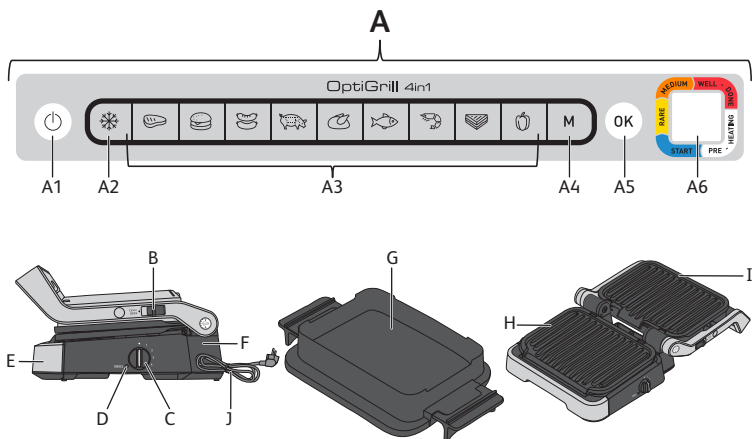

## POSITIONS ET INTERFACES

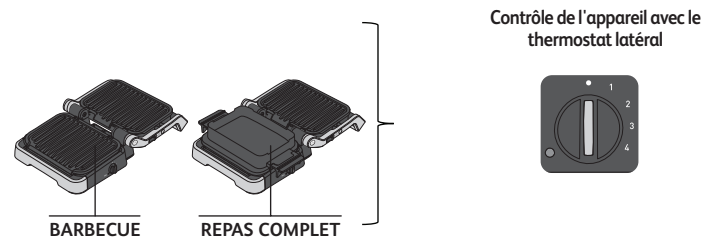
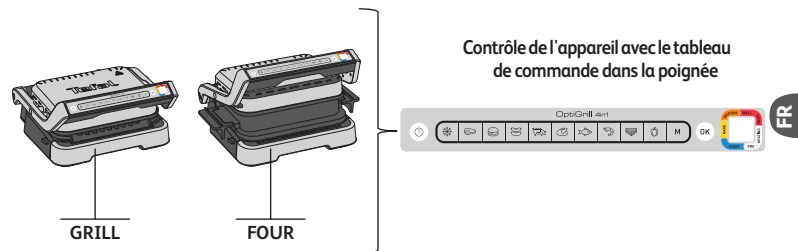

## CHANGEMENT DE POSITION

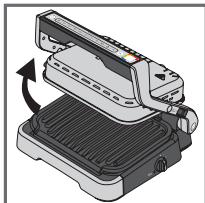

### Pour mettre en position four :

Ouvrez le grill, retirez la plaque inférieure et remplacez-la par l'accessoire four.

**Attention :** l'accessoire four se pose sur le grill sans verrouillage.

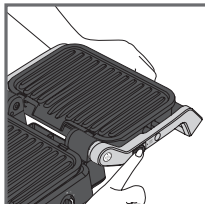
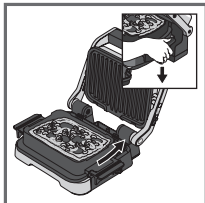

### Pour mettre en position barbecue :

En ouvrant le grill, maintenez le loquet soulevé et accompagnez la poignée jusqu'à la position barbecue.

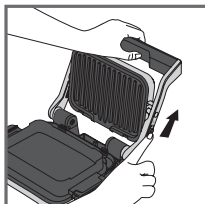
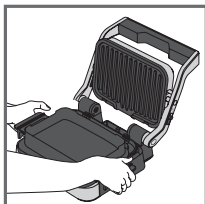

### Pour mettre en position repas complet :

Placez l'accessoire four à la place de la plaque inférieure et ouvrez à 180° en suivant les étapes ci-dessus.

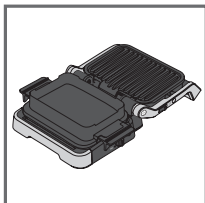

**Attention :** Vérifiez que le thermostat latéral est sur • avant d'ouvrir en barbecue ou position repas complet. Si le thermostat n'est pas sur •, le grill commencera à chauffer et vous avertira avec un signal sonore.

## INDICATEUR DU NIVEAU DE CUISSON

### Préchauffage



Couleur blanche clignotante : préchauffage en cours



Couleur blanche fixe avec signal sonore : prêt à cuire

### Cuisson



Premier niveau de cuisson en cours



Premier niveau de cuisson atteint



Niveau "saignant" en cours



Niveau "saignant" atteint



Niveau « à point » en cours



Niveau « à point » atteint



Niveau « bien cuit » en cours



Niveau « bien cuit » atteint

Pour les différents programmes automatiques, Optigrill vous informe lorsque le niveau de cuisson désiré est atteint. Lorsqu'un niveau de cuisson est atteint, l'indicateur de cuisson devient fixe et le grill émet un signal sonore pour vous avertir.

## AVANT LA PREMIÈRE UTILISATION

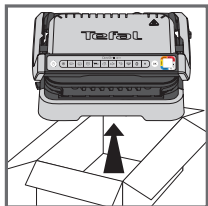

1

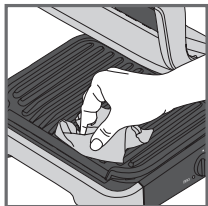

2

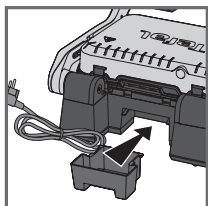

3

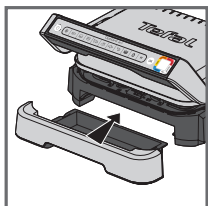

4

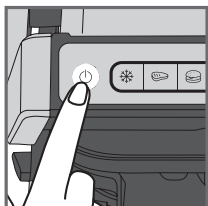

5

1. Enlevez tous les emballages, autocollants ou accessoires divers à l'intérieur comme à l'extérieur de l'appareil. Des anneaux coloriels additionnels sont fournis pour l'indicateur de cuisson. Vous pouvez coller l'anneau avec la langue que vous souhaitez sur l'anneau de cuisson d'origine.
  2. Avant la première utilisation, nettoyez soigneusement les plaques avec de l'eau chaude et du liquide vaisselle, rincez et séchez soigneusement.
  3. Installez les bacs à jus à l'avant et à l'arrière de l'appareil.
  4. Assurez-vous que les plaques supérieure et inférieure sont correctement positionnées dans le produit. Ne démarrez pas le préchauffage sans plaques. Branchez l'appareil sur le secteur (le cordon doit être entièrement déroulé).
  5. Appuyez sur le bouton marche / arrêt.
- Attention :** Assurez vous qu'il n'y a pas d'aliments entre les plaques.

## 1. POSITION GRILL

### A) UTILISATION D'UN PROGRAMME AUTOMATIQUE

9 programmes automatiques : viande rouge, steak haché, saucisse, porc, poulet, poisson, fruits de mer, sandwich, poisson

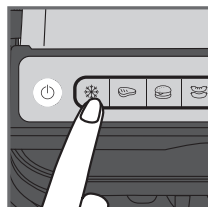

1

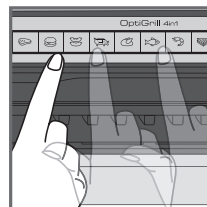

2

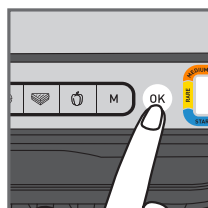

3

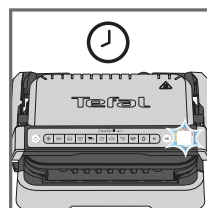

4

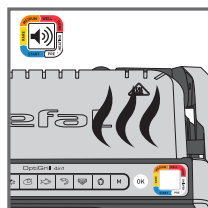

5

1. Si l'aliment à cuire est congelé, appuyez sur le bouton correspondant. Cette fonction fonctionne uniquement avec les programmes automatiques, pas en mode manuel.
2. Sélectionnez le programme de cuisson approprié en fonction du type d'aliment à cuire.

**Conseil, notamment pour la viande :** les résultats de cuisson des programmes automatiques peuvent varier selon l'origine, la découpe et la qualité de l'aliment à cuire, les programmes ayant été définis et testés avec des aliments de bonne qualité.

De même, l'épaisseur de la viande doit être prise en compte lors de la cuisson; vous ne devez pas faire cuire d'aliments de plus de 4 cm d'épaisseur.

En cas de doute sur le programme de cuisson à utiliser, reportez-vous au guide de cuisson.

3. Appuyez sur le bouton « OK » : l'appareil commence le préchauffage et l'indicateur de niveau de cuisson clignote blanc.
- Remarque :** si vous sélectionnez un programme par erreur, éteignez l'appareil et recommencez les étapes précédentes.
4. Attendez que le préchauffage soit fini.
5. Un signal sonore retentit et l'indicateur du degré de cuisson cesse de clignoter blanc pour signaler que le préchauffage est terminé.

**Commentaire :** si l'appareil demeure fermé trop longtemps une fois le préchauffage terminé, le système de sécurité mettra l'appareil hors tension après un certain temps.



## 1. POSITION GRILL

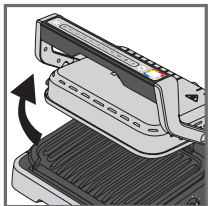

6

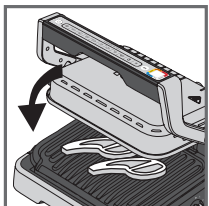
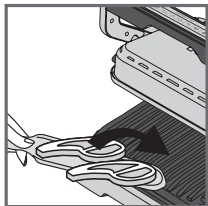

7

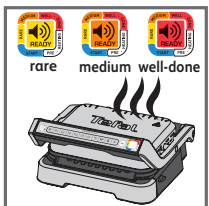
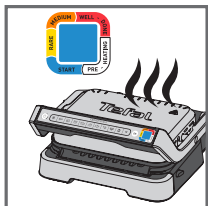

8

6. Ouvrez le grill et mettez la nourriture sur la plaque de cuisson.

**Commentaire :** si l'appareil demeure ouvert trop longtemps, le système de sécurité mettra l'appareil hors tension automatiquement après un certain temps

7. Fermez l'appareil pour débiter le cycle de cuisson. L'indicateur du degré de cuisson devient bleu pour indiquer que la cuisson est en cours (pour obtenir de meilleurs résultats, évitez d'ouvrir l'appareil ou de déplacer vos aliments pendant la cuisson). L'appareil sélectionne automatiquement le cycle de cuisson (temps et température) selon la quantité et l'épaisseur des aliments.

**Remarque pour les aliments très fins :** Le bouton "OK" clignote et l'indicateur reste blanc fixe. Appuyez alors sur "OK" pour s'assurer que l'appareil reconnaisse bien l'aliment et que le cycle de cuisson démarre.

8. Selon le niveau de cuisson, l'indicateur change de couleur. Pendant que la cuisson est en cours, un signal sonore vous indique lorsqu'un nouveau niveau est atteint. Lorsque l'indicateur est jaune fixe et accompagné d'un signal sonore, votre aliment est saignant, orange fixe avec signal sonore, l'aliment est à point, rouge fixe avec signal sonore l'aliment est bien cuit.

**Remarque :** pour obtenir un degré de cuisson « bleu », retirez la viande quand l'indicateur de degré de cuisson devient bleu fixe. Notez, notamment pour la viande, qu'il est normal que les résultats de cuisson varient selon le type, la qualité et l'origine de la nourriture.

## 1. POSITION GRILL

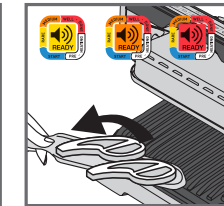
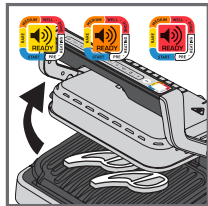

9

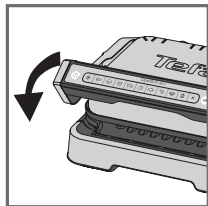

10

9. Lorsque la couleur correspondant à votre degré de cuisson désiré apparaît fixe et que le signal sonore retentit, ouvrez l'appareil et retirez vos aliments.

En fonction des préférences personnelles ouvrez le grill et retirez les aliments ayant atteint le degré de cuisson souhaité, puis refermez le grill pour poursuivre la cuisson des autres aliments. Le programme poursuivra le cycle de cuisson jusqu'au degré final.

10. Lorsque la cuisson est terminée, retirez les aliments et fermez l'appareil. Le tableau de commande s'allume et se met en mode « Sélection de programme ».

**Commentaire :** le système de sécurité mettra l'appareil hors tension automatiquement après un certain temps si aucun programme n'est sélectionné.

### Fonction de maintien au chaud

Lorsque le niveau rouge est atteint, la cuisson est terminée, l'appareil active automatiquement la fonction de maintien au chaud, l'indicateur devient rouge et un signal sonore retentit toutes les 20 secondes. Si l'aliment est laissé sur le grill, il continuera de cuire pendant le refroidissement des plaques de cuisson. Vous pouvez arrêter le signal sonore en appuyant sur le bouton « OK ».

**Commentaire :** le système de sécurité mettra l'appareil hors tension automatiquement après un certain temps.

### Enchaîner sur une deuxième cuisson :

Une fois que la cuisson de votre première quantité d'aliments est terminée :

- Assurez-vous que l'appareil est fermé et qu'il n'y a pas d'aliments à l'intérieur.
- Sélectionnez le programme de cuisson approprié (cette étape est nécessaire même si le programme est le même que pour les aliments précédents).
- Appuyez sur le bouton « OK » pour commencer le préchauffage. Pendant le préchauffage, l'indicateur du degré de cuisson clignote blanc.
- Une fois le préchauffage terminé, un signal sonore retentit et l'indicateur du degré de cuisson devient blanc fixe.
- L'appareil est prêt à être utilisé une fois le préchauffage terminé. Ouvrez le grill et mettez les aliments sur la plaque.

### Important :

- Veillez noter que le préchauffage est obligatoire pour chaque nouvelle cuisson. Avant de lancer le préchauffage, assurez-vous que l'appareil est fermé et qu'il n'y a pas d'aliments à l'intérieur. Attendez que le préchauffage soit terminé avant d'ouvrir le grill et de mettre des aliments à l'intérieur.
- Si le nouveau cycle de préchauffage est lancé immédiatement après la fin du cycle précédent, le temps de préchauffage sera plus court.

# 1. POSITION GRILL

## B) UTILISATION DU MODE MANUEL

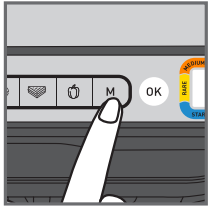

1

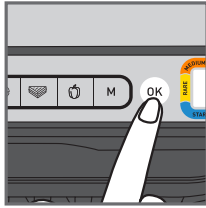

2

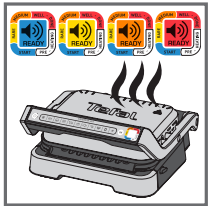

3

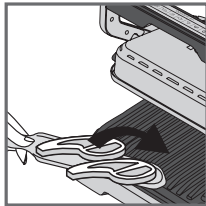

4



5

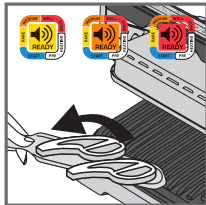

6

- Sélectionnez le mode manuel et la température de cuisson en cliquant sur **M** à plusieurs reprises jusqu'à ce que la couleur désirée s'affiche :

	110-125°C
	180-195°C
	220-235°C
	255-275°C

- Appuyez sur **OK** pour démarrer le préchauffage. L'indicateur de niveau de cuisson clignote de la couleur choisie : préchauffage en cours. Attendez la fin du préchauffage.
- Quand la température choisie est atteinte, l'indicateur arrête de clignoter et un signal sonore retentit : le grill est prêt à cuire
- Placez la nourriture sur le grill, la cuisson démarre.
- Vous pouvez ajuster la température pendant la cuisson.
- Surveillez la nourriture et retirez-la du grill lorsque la cuisson vous convient.

# 1. POSITION GRILL

## C) GUIDE DE CUISSON

### 9 PROGRAMMES AUTOMATIQUES

	INDICATEUR DU NIVEAU DE CUISSON			
BOEUF	Bleu	Saignant	A point	Bien cuit
STEAK HACHÉ	-	Saignant	A point	Bien cuit
SAUCISSE	-	-	-	Bien cuit
PORC	-	-	-	Bien cuit
POULET	-	-	-	Bien cuit
POISSON	-	A point	A point plus	Bien cuit
FRUITS DE MER	-	A point	A point plus	Bien cuit
SANDWICH	-	Légèrement cuit	Toasté	Croustillant
POIVRON	-	-	Croquant	Fondant

### MODE MANUEL EN POSITION GRILL

	 De 180°C à 195°C	 de 220°C à 235°C	 de 255°C à 275°C
POMME DE TERRE			
COURGETTES			
AUBERGINES			
TOMATES			
ASPERGES			
CHAMPIGNONS			
ONIONS			
BROCOLI			
CAROTTES			
FENOUIL			
PATATES DOUCES			
POMMES EN RONDELLES			
ANANAS			
PÊCHE			

## 2. POSITION FOUR

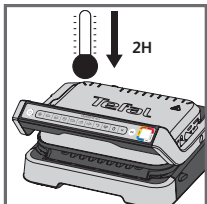

1

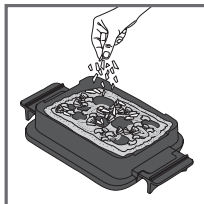

2



3

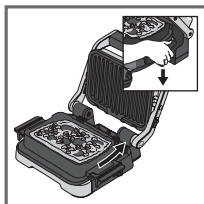

4

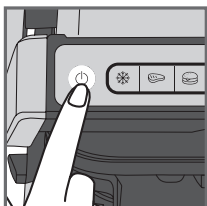

5

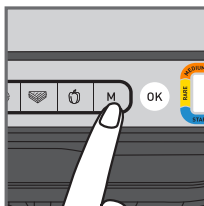

6

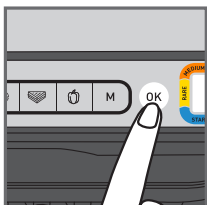



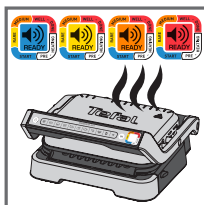

7



8

1. Si votre Optigrill est déjà en marche et que vous voulez utiliser votre accessoire four, débranchez le grill et laissez-le refroidir pendant au moins 2 heures.
2. Mettez les ingrédients dans l'accessoire four.
3. Ouvrez le grill, retirez la plaque de cuisson inférieure et remplacez la par votre accessoire four.  
**ATTENTION** : Veillez à ce que la plaque grill supérieure soit correctement positionnée dans l'appareil.
4. Fermez le grill et appuyer sur le bouton marche/arrêt.
5. Sélectionnez le mode manuel et la température de cuisson en cliquant sur M à plusieurs reprises jusqu'à ce que la couleur désirée s'affiche :

	85-110°C
	150-165°C
	190-205°C
	240-255°C

6. Démarrez le préchauffage en appuyant sur le bouton **OK**
7. Quand la température souhaitée est atteinte, le grill émet un signal sonore. Le processus de cuisson commence.

## 2. POSITION FOUR

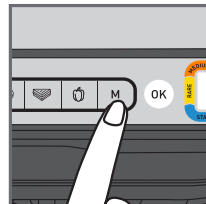

8

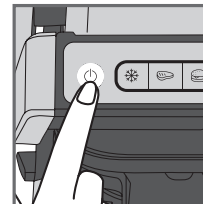

9

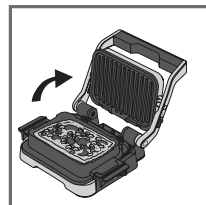

10



11

8. Vous pouvez ajuster la température pendant la cuisson.
9. Surveillez la cuisson de la nourriture et lorsque celle-ci vous convient, terminez la cuisson en appuyant sur le bouton marche/arrêt. Les boutons s'éteignent, le grill arrête de chauffer et de cuire.
10. Ouvrez le grill et retirez l'accessoire four en le prenant par ses poignées  
**ATTENTION** : Les surfaces sont chaudes, il est recommandé d'utiliser des gants. L'accessoire four est chaud, veillez à le placer sur une surface adaptée.
11. L'accessoire four passe au lave-vaisselle.

### 3. POSITION BARBECUE

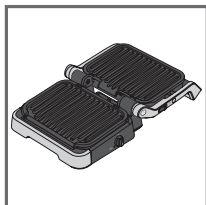

1

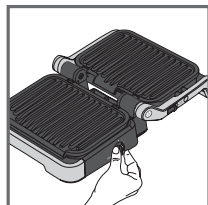

2

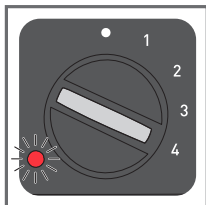

3

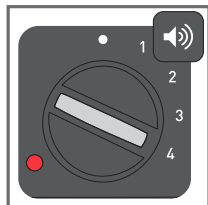

4

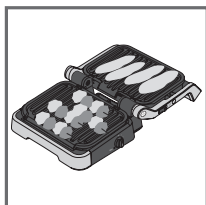

5

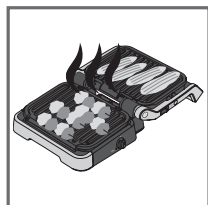

6

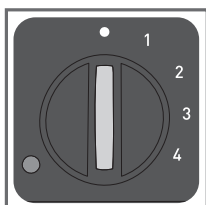

7

1. Ouvrez le grill en position barbecue. La cuisson est gérée avec le thermostat latéral.
2. Sélectionnez le réglage de température souhaité. Le thermostat définit la même température de cuisson pour les deux plaques.

• Thermostat éteint
1: 80-100°C
2: 130-160°C
3: 160-190°C
4: 180-220°C

3. La led clignote rouge pendant le préchauffage.
4. Quand la led devient rouge fixe et que le signal sonore retentit, the grill est prêt à cuire.
5. Placez la nourriture sur le grill, la cuisson démarre.
6. Surveillez les aliments et retirez-les du grill lorsque la cuisson vous convient
7. Eteignez l'appareil en positionnant le thermostat sur •.

#### Commentaires :

- Vous pouvez changer le réglage de température pendant la cuisson. Si la température est changée en cours de cuisson, le grill ajuste la température selon le nouveau réglage.
- Si vous n'utilisez qu'une des deux plaques, privilégiez la plaque supérieure.

### 4. POSITION REPAS COMPLET

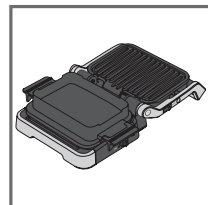

1

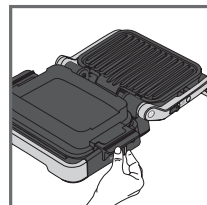

2

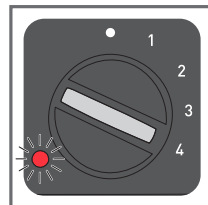

3

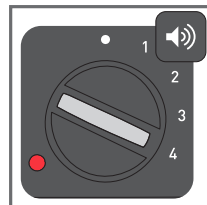

4

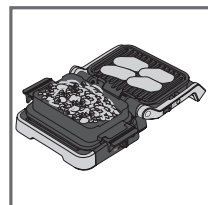

5

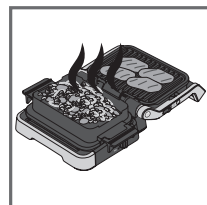

6

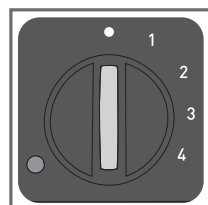

7

1. Placez le grill en position repas complet. La cuisson est gérée avec le thermostat latéral.
2. Sélectionnez le réglage de température souhaité. Le réglage du thermostat contrôle la température des deux plaques.

• Thermostat éteint
1: 80-100°C
2: 130-160°C
3: 160-190°C
4: 180-220°C

3. La led clignote rouge pendant le préchauffage.
4. Quand la led devient rouge fixe et que le signal sonore retentit, the grill est prêt à cuire.
5. Ajoutez les aliments sur le grill et dans l'accessoire four.
6. Surveillez les aliments et retirez-les du grill lorsque la cuisson vous convient
7. Eteignez l'appareil en positionnant le thermostat sur •.

#### Commentaires :

- Vous pouvez changer le réglage de température pendant la cuisson. Si la température est changée en cours de cuisson, le grill ajuste la température selon le nouveau réglage.

#### Conseils :

Si le temps de cuisson de votre accompagnement est plus long que celui de votre grillade, vous pouvez également commencer la cuisson en position four. Dans ce cas, reportez vous à la page xx et suivez les étapes de 1 à 7. Lorsque le niveau de cuisson désiré est atteint, ouvrez votre grill en position repas complet. Le grill bascule automatiquement sur le thermostat latéral. Sélectionnez le réglage désiré à l'aide du thermostat. Lorsque la plaque grill est préchauffée, ajoutez l'aliment sur la plaque grill.

## FIN DE CUISSON

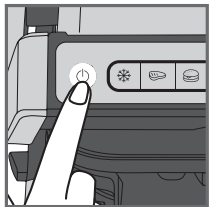

1

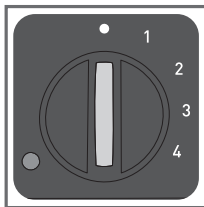

- Eteignez l'appareil :
  - Appuyez sur le bouton marche/arrêt en position grill et four.
  - Positionnez le thermostat sur • en position barbecue et repas complet
- Débranchez l'appareil.
- Laissez refroidir pendant au moins 2 heures. Pour éviter des brûlures accidentelles, laissez le grill refroidir complètement avant de procéder à son nettoyage.

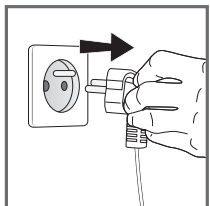

2

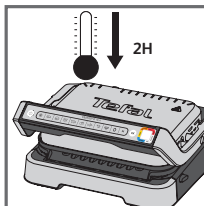

3

## NETTOYAGE

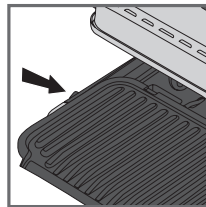

1

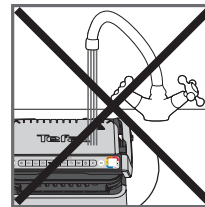

2

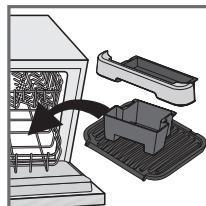

3

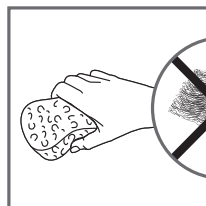

4

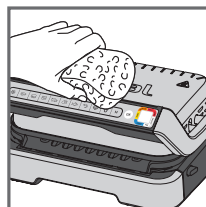
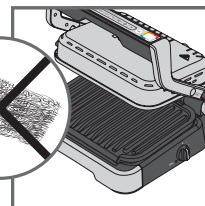

5

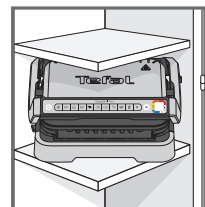

6

- Avant le nettoyage, retirez les plaques, les bacs à jus et l'accessoire four pour éviter d'endommager la surface de cuisson. Videz les bacs à jus et lavez-les dans de l'eau chaude légèrement savonneuse, puis essuyez-les soigneusement à l'aide d'un essuie-tout.
- N'immergez pas le grill dans de l'eau ou tout autre liquide.
- L'appareil et son cordon ne doivent jamais être mis au lave-vaisselle. Les éléments chauffants (les résistances) ne doivent jamais être nettoyés après que les plaques aient été enlevées. S'ils sont très sales, attendez que l'appareil ait complètement refroidi et nettoyez-les à l'aide d'un chiffon sec.
- Si vous ne voulez pas mettre les plaques, les bacs à jus et l'accessoire four au lave-vaisselle, utilisez de l'eau chaude et un peu de liquide vaisselle pour les laver, puis rincez-les abondamment pour enlever tout résidu. Essuyez-les soigneusement avec un essuie-tout. N'utilisez pas de tampon à récurer métallique, de laine d'acier ou de produits de nettoyage abrasifs pour nettoyer toute partie du grill, utilisez uniquement des tampons de nettoyage en nylon ou non métalliques.
- Pour nettoyer le capot du grill, passez une éponge imprégnée d'eau chaude et essuyez avec un chiffon doux et sec.
- Assurez-vous toujours que le grill est propre et sec avant de le ranger.

Toute réparation doit être effectuée par un représentant de service agréé.

# Guide de dépannage

Problème	Cause	Solution
<p>Boutons  clignotant</p> <p>+  Indicateur <b>bleu fixe</b></p> <p>+ Bouton  clignotant</p>	<ul style="list-style-type: none"> <li>Mise en marche de l'appareil ou démarrage d'un cycle de cuisson auto avec aliments et sans préchauffage des plaques (le mode manuel est automatiquement mis en marche).</li> </ul>	<ul style="list-style-type: none"> <li>2 options possibles :               <ul style="list-style-type: none"> <li>Sélectionnez la température en appuyant sur le bouton  puis sur « <b>OK</b> ». Laissez cuire tout en surveillant la cuisson (car utilisation en mode manuel).</li> <li>Arrêtez l'appareil, retirez la nourriture, fermez correctement l'appareil, reprogrammez l'appareil et attendez la fin du préchauffage.</li> </ul> </li> </ul>
<p>L'appareil s'arrête tout seul pendant le cycle de préchauffage ou de cuisson.</p>	<ul style="list-style-type: none"> <li>L'appareil est resté ouvert trop longtemps en cours de cuisson.</li> <li>L'appareil est demeuré au repos trop longtemps après la fin du préchauffage ou du maintien au chaud.</li> </ul>	<ul style="list-style-type: none"> <li>Débranchez l'appareil de la prise, attendez 2 à 3 minutes, recommencez le processus. La prochaine fois que vous utiliserez l'appareil, veillez à l'ouvrir et à le refermer rapidement pour obtenir de meilleurs résultats de cuisson. Si le problème persiste, contactez votre service clientèle Tefal local.</li> </ul>
<p> Indicateur <b>Violet clignotant</b></p> <p>+ bouton  /  /  /  clignotant</p> <p>+ bip intermittent</p> <p>L'appareil ne produit plus de signaux sonores.</p>	<ul style="list-style-type: none"> <li>Défaillance de l'appareil.</li> <li>Appareil rangé ou utilisé dans un local trop froid.</li> </ul>	<ul style="list-style-type: none"> <li>Débranchez, rebranchez immédiatement votre appareil et relancez un cycle de préchauffage. Si le problème persiste, contactez le service clientèle.</li> </ul>
<p> Indicateur <b>Violet clignotant</b></p> <p>+ bouton  clignotant</p> <p>+ signal sonore continu</p>	<ul style="list-style-type: none"> <li>Panne de l'appareil</li> </ul>	<ul style="list-style-type: none"> <li>Débranchez l'appareil et contactez votre service clientèle.</li> </ul>
<p>Après la préchauffe, j'ai mis en place la nourriture et fermé l'appareil,  l'indicateur reste blanc et la cuisson ne démarre pas</p>	<ul style="list-style-type: none"> <li>Vous n'avez pas entièrement ouvert le gril pour mettre en place la nourriture.</li> <li>Aliment non détecté <b>L'aliment est trop mince, « OK » clignote.</b></li> </ul>	<ul style="list-style-type: none"> <li>L'épaisseur de l'aliment ne doit pas être supérieure à 4 cm.</li> <li>Ouvrez complètement le gril, puis refermez-le.</li> <li>Confirmez le début de la cuisson en appuyant sur le bouton .</li> </ul>
<p>L'appareil se met en mode manuel</p> <p>+  Indicateur <b>rouge clignotant</b></p> <p>+ bouton  temp control et  allumés fixe</p>	<ul style="list-style-type: none"> <li>Le temps de préchauffage n'est pas complètement écoulé.</li> </ul>	<ul style="list-style-type: none"> <li>Laissez cuire tout en surveillant la cuisson (car utilisation en mode manuel) ou</li> <li>Arrêtez le gril, retirez les aliments, fermez le gril, sélectionnez à nouveau le programme souhaité et attendez la fin du préchauffage.</li> </ul>

## INDICE

- Descrizione del prodotto 76
- Posizioni e interfacce 77
- Cambio di posizione 78
- Indicatore del livello di cottura 79
- Prima del primo utilizzo 80
- 1. Posizione grill 81
  - a) Usare un programma automatico 81
  - b) Usare modalità manuale 84
  - c) Guida alla cottura 85
- 2. Posizione forno 87
- 3. Posizione barbecue 88
- 4. Posizione pasto completo 89
- A fine utilizzo 90
- Pulizia 91
- Guida alla risoluzione dei problemi 92

## DESCRIZIONE DEL PRODOTTO

- A. Pannello di controllo
- A1. Pulsante di accensione/spegnimento
- A2. Funzione Alimenti surgelati
- A3. 9 Programmi automatici di cottura
- A4. Modalità manuale a 4 temperature
- A5. Confermare la selezione e avviare il preriscaldamento
- A6. Indicatore del livello di cottura
- B. Fermo di rilascio per posizioni barbecue e pasto completo
- C. Termostato laterale per posizioni barbecue e pasto completo
- D. Spia luminosa per posizioni barbecue e pasto completo
- E. Vassoio raccogliogocce anteriore
- F. Vassoio raccogliogocce posteriore
- G. Accessorio da forno
- H. Piastra inferiore
- I. Piastra superiore
- J. Cavo di alimentazione

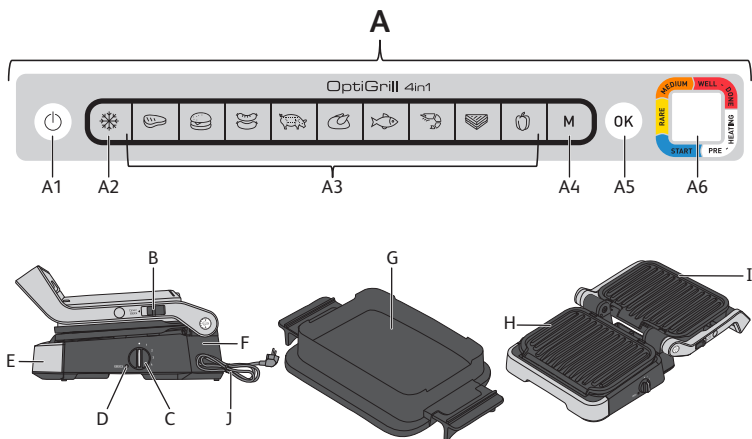

## POSIZIONI E INTERFACCE

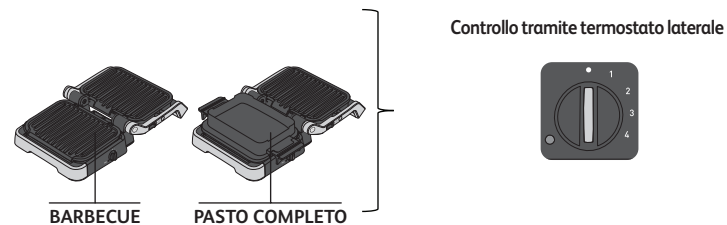
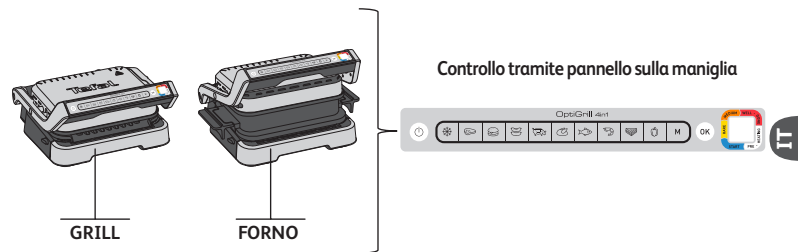

## CAMBIO DI POSIZIONE

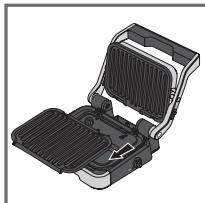
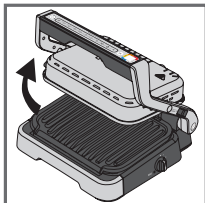

### Passare alla posizione forno:

aprire il grill, rimuovere la piastra grill inferiore e sostituirla con l'accessorio da forno.

**Attenzione:** l'accessorio da forno è posizionato sul grill senza essere bloccato in posizione.

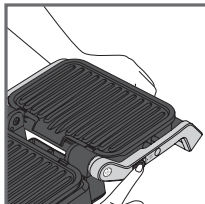

### Passare alla posizione barbecue:

quando si apre il grill, tenere sollevato il fermo di rilascio e portare la maniglia in posizione barbecue aperta a 180°.

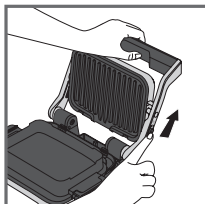
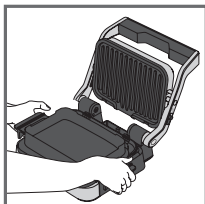

### Passare alla posizione pasto completo:

inserire l'accessorio da forno al posto della piastra inferiore, quindi aprire il grill a 180° seguendo la procedura descritta sopra.

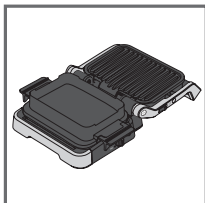

**Attenzione:** controllare che il termostato laterale sia impostato su • prima di aprire il grill in posizione barbecue o pasto completo. Se il termostato non è su •, il grill inizia a riscaldarsi e verrà emesso un segnale acustico.

## INDICATORE DEL LIVELLO DI COTTURA

### Preriscaldamento



Spia bianca lampeggiante: preriscaldamento in corso



Spia bianca fissa e segnale acustico: pronto per cucinare

### Cottura



Primo livello di cottura in corso



Primo livello di cottura raggiunto



Livello "Cottura al sangue" in corso



Livello "Cottura al sangue" raggiunto



Livello "Cottura media" in corso



Livello "Cottura media" raggiunto



Livello "Ben cotto" in corso



Livello "Ben cotto" raggiunto

Per ogni programma automatico, OptiGrill avvisa l'utente quando viene raggiunto il livello di cottura desiderato. Quando viene raggiunto un livello di cottura, l'indicatore colorato diventa fisso e il grill emette un segnale acustico per avvisare l'utente.



## PRIMA DEL PRIMO UTILIZZO

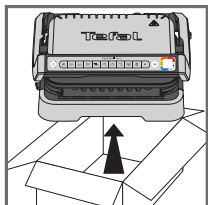

1



2

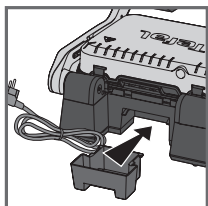

3

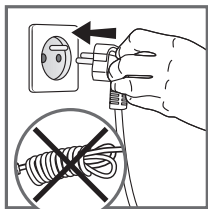
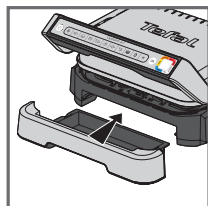

4

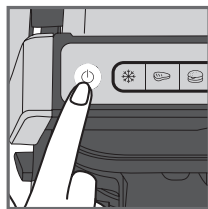

5

1. Rimuovere tutti i materiali di imballaggio, gli adesivi e gli accessori dall'interno e dall'esterno dell'apparecchio. Sono forniti adesivi ad anello colorati aggiuntivi. È possibile incollare la lingua preferita sull'anello di colore originale.
2. Prima di utilizzare le piastre per la prima volta, pulirle accuratamente con acqua calda e un po' di detersivo per piatti, sciacquarle e asciugarle accuratamente.
3. Posizionare i vassoi raccogliogocce rimovibili sulla parte anteriore e posteriore dell'apparecchio.
4. Assicurarsi che le piastre di cottura superiore e inferiore siano posizionate correttamente nell'apparecchio. Non attivare il preriscaldamento senza le piastre. Collegare l'apparecchio alla presa di corrente (il cavo deve essere completamente srotolato).
5. Premere il pulsante di avvio/arresto.

**Attenzione:** assicurarsi che non vi siano alimenti tra le piastre

## 1. POSIZIONE GRILL

### A) USARE UN PROGRAMMA AUTOMATICO

9 programmi automatici: carne rossa, hamburger, salsicce, maiale, pollo, pesce, frutti di mare, sandwich, peperoni

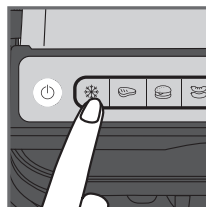

1

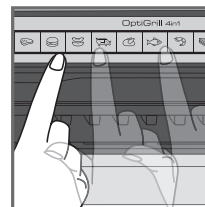

2

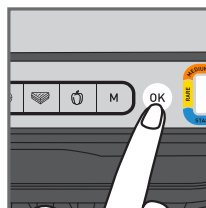

3

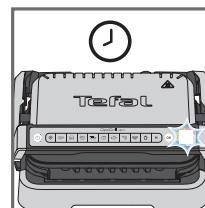

4

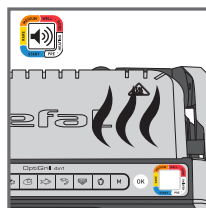

5

1. Se il cibo che si desidera cuocere è congelato, premere il pulsante corrispondente. Questa funzione è disponibile solo durante la cottura con i programmi automatici, non in modalità manuale.
2. Selezionare il programma di cottura appropriato in base al tipo di cibo che si desidera cucinare.

**Consiglio, specialmente per la carne:** i risultati della cottura con i programmi automatici possono variare a seconda dell'origine, del taglio e della qualità del cibo che viene cotto, i programmi sono stati impostati e testati per un cibo di buona qualità.

Allo stesso modo, deve essere preso in considerazione lo spessore della carne durante la cottura; non si devono cuocere cibi con uno spessore superiore a 4 cm. In caso di dubbi sul programma di cottura da utilizzare, fare riferimento alla pagina xx della guida alla cottura.

3. Premere il pulsante "OK": l'apparecchio inizia il preriscaldamento e l'indicatore del livello di cottura lampeggia in bianco.  
**Nota:** se è stato selezionato il programma errato, spegnere l'apparecchio e ripetere la procedura.
4. Attendere il completamento del preriscaldamento.
5. Quando l'indicatore del livello smette di lampeggiare in bianco e il grill emette un segnale acustico, il preriscaldamento è completo e il grill è pronto per la cottura.

**Commenti:** al termine del preriscaldamento, se l'apparecchio rimane chiuso, il sistema di sicurezza spegnerà l'apparecchio dopo un po' di tempo.

## 1. POSIZIONE GRILL

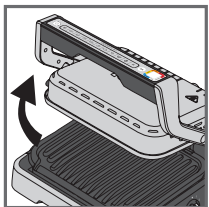

6

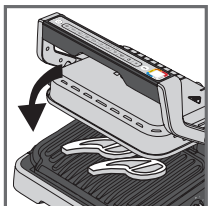
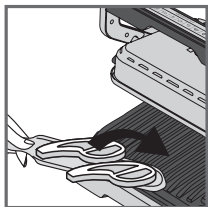

7

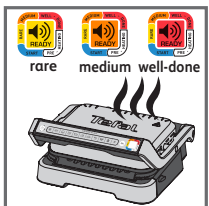
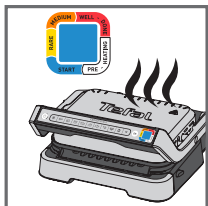

8

6. Aprire il grill e posizionare gli alimenti sulla piastra di cottura.

**Commenti:** se l'apparecchio rimane aperto troppo a lungo, il sistema di sicurezza spegnerà automaticamente l'apparecchio dopo un po' di tempo.

7. Chiudere l'apparecchio per avviare il ciclo di cottura. L'indicatore del livello di cottura diventa blu a indicare che la cottura è in corso (per risultati ottimali, non aprire o spostare il cibo durante la cottura). L'apparecchio calcola automaticamente i parametri di cottura (tempo e temperatura) in base alla quantità e allo spessore degli alimenti.

**Nota per i pezzi molto sottili di alimenti:** chiudere l'apparecchio, il pulsante **OK** lampeggia e l'indicatore rimane bianco fisso fino a quando non si preme **OK**. Premere **OK** per verificare che l'apparecchio riconosca gli alimenti e che il ciclo di cottura inizi.

8. A seconda del livello di cottura, la spia luminosa cambia colore. Durante la cottura, viene emesso un segnale acustico ogni volta che viene raggiunto il livello di cottura. Quando la spia è gialla con un segnale acustico, gli alimenti sono "al sangue", arancione con un segnale acustico, gli alimenti sono mediamente cotti e rossa con un segnale acustico, gli alimenti sono ben cotti.

**Nota:** se si desidera una carne molto al sangue, toglierla quando l'indicatore del livello di cottura raggiunge il blu fisso. Soprattutto per la carne, è normale che i risultati della cottura possano variare a seconda del tipo, della qualità e della provenienza.

## 1. POSIZIONE GRILL

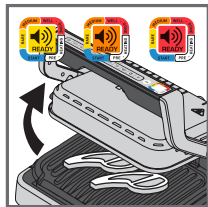

9

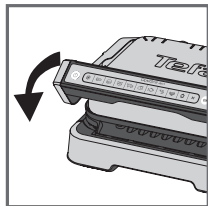
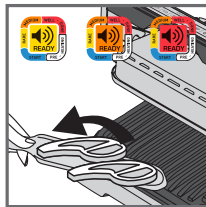

10

9. Quando il colore corrispondente al livello di cottura desiderato diventa fisso e viene emesso un segnale acustico, aprire l'apparecchio e rimuovere gli alimenti.

**Nota:** se si desidera cuocere gli alimenti in base ai diversi gusti personali, aprire il grill e rimuovere il cibo una volta raggiunto il livello desiderato, quindi chiudere il grill e continuare la cottura degli altri alimenti. Il programma continuerà il suo ciclo di cottura fino a raggiungere il livello finale.

10. Al termine della cottura, rimuovere gli alimenti e chiudere l'apparecchio. Il pannello di controllo si accende e si imposta sulla modalità "scelta del programma".

**Commento:** il sistema di sicurezza si spegne automaticamente dopo un certo periodo di tempo se non viene effettuata alcuna selezione del programma.

### Funzione di mantenimento al caldo

Una volta raggiunto il livello rosso, la cottura è terminata, l'apparecchio attiva automaticamente la funzione di mantenimento al caldo, la spia è rossa e il dispositivo inizia a emettere un segnale acustico ogni 20 secondi. Se il cibo rimane sul grill, continuerà a cuocere mentre le piastre si raffreddano. Per disattivare il segnale acustico, premere il pulsante **OK**.

**Nota:** il sistema di sicurezza spegne automaticamente l'apparecchio dopo un certo periodo di tempo.

### Cottura immediata di un secondo lotto di cibo:

Una volta terminata la cottura del primo lotto di cibo:

- Assicurarsi che l'apparecchio sia chiuso e che non vi siano residui di cibo all'interno.
- Selezionare il programma di cottura (questo passaggio è necessario anche se il programma è lo stesso della cottura precedente).
- Premere il pulsante **"OK"** per avviare il preriscaldamento. Durante il preriscaldamento, l'indicatore del livello lampeggia in bianco.
- Al termine del preriscaldamento, l'apparecchio emette un segnale acustico e la spia luminosa diventa bianca fissa.
- L'apparecchio è pronto per essere utilizzato una volta completato il preriscaldamento. Aprire il grill e posizionare gli alimenti all'interno dell'apparecchio.

### Importante:

- Il preriscaldamento è necessario per ogni nuovo lotto. Prima di preriscaldare, assicurarsi che l'apparecchio sia chiuso e che non vi siano residui di cibo all'interno. Attendere il termine del preriscaldamento prima di aprire l'apparecchio e di inserire gli alimenti.
- Se il nuovo ciclo di preriscaldamento viene attivato immediatamente dopo la fine del ciclo precedente, il tempo di preriscaldamento è ridotto.

# 1. POSIZIONE GRILL

## B) USAODALITÀ MANUALE

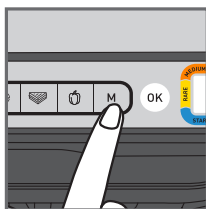

1

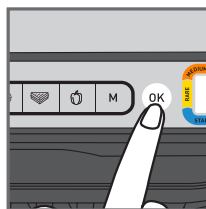

2

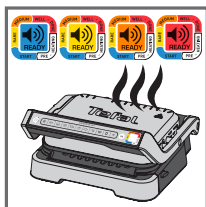

3

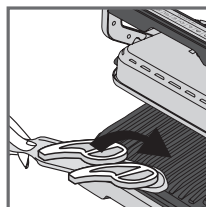

4

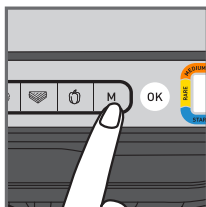

5

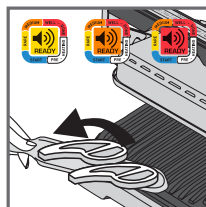

6

1. Selezionare la modalità manuale e la temperatura di cottura facendo click su M più volte fino a quando il colore non corrisponde alla temperatura desiderata:

	110-125°C
	180-195°C
	220-235°C
	255-275°C

2. Premere **OK** per avviare il preriscaldamento. L'indicatore del livello di cottura lampeggia con il colore selezionato: preriscaldamento in corso. Attendere che il preriscaldamento sia terminato.
3. Una volta raggiunta la temperatura desiderata, la spia smette di lampeggiare e il grill emette un segnale acustico: il grill è pronto per la cottura.
4. Aggiungere gli alimenti sul grill, il processo di cottura inizia.
5. È possibile regolare la temperatura durante la cottura.
6. Controllare il cibo durante la cottura e toglierlo quando lo si ritiene cotto come desiderato.

# 1. POSIZIONE GRILL

## C) GUIDA ALLA COTTURA

### 9 PROGRAMMI AUTOMATICI DI COTTURA

		INDICATORE DEL LIVELLO DI COTTURA			
	<b>MANZO</b>	Molto al sangue (blu)	Al sangue	Cottura media	Ben cotta
	<b>HAMBURGER</b>	-	Al sangue	Cottura media	Ben cotta
	<b>SALSICCIA</b>	-	-	-	Ben cotta
	<b>MAIALE</b>	-	-	-	Ben cotta
	<b>POLLO</b>	-	-	-	Ben cotta
	<b>PESCE</b>	-	Cottura media	Buona cottura media	Ben cotta
	<b>FRUTTI DI MARE</b>	-	Cottura media	Buona cottura media	Ben cotta
	<b>SANDWICH</b>	-	Cottura leggera	Grigliato	Croccante
	<b>PEPERONI</b>	-	-	Leggermente grigliati	Grigliati

### MODALITÀ MANUALE IN POSIZIONE GRILL

	Da 180°C a 195°C	Da 220°C a 235°C	Da 255°C a 275°C
<b>PATATE</b>			
<b>ZUCCHINE/ZUCCA</b>			
<b>MELANZANE</b>			
<b>POMODORI</b>			
<b>ASPARAGI</b>			
<b>FUNGHI</b>			
<b>CIPOLLE</b>			
<b>BROCCOLI</b>			
<b>CAROTINE</b>			
<b>FINOCCHI</b>			
<b>PATATE DOLCI</b>			
<b>FETTINE DI MELA</b>			
<b>ANANAS</b>			
<b>PESCHE</b>			

## 2. POSIZIONE FORNO

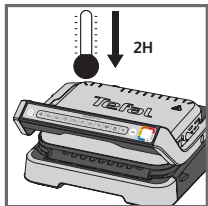

1



2



3

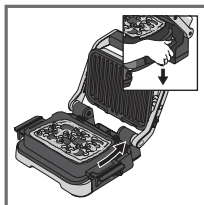

4

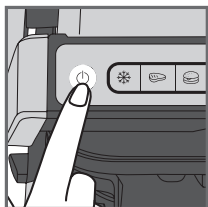

5

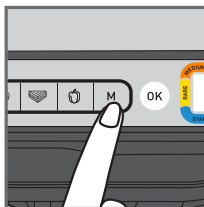

6

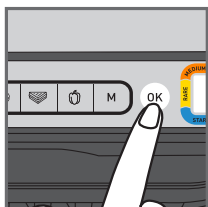



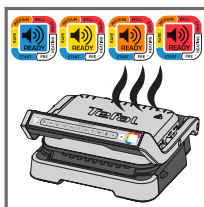

7



8

1. Se l'OptiGrill è già acceso e si desidera utilizzare l'accessorio da forno, scollegare il grill e lasciarlo raffreddare per almeno 2 ore.
2. Mettere gli ingredienti nell'accessorio da forno.
3. Aprire il grill, rimuovere la piastra grill inferiore e sostituirla con l'accessorio da forno.  
**ATTENZIONE:** assicurarsi che la piastra grill superiore sia installata correttamente nell'apparecchio.
4. Chiudere il grill e premere il pulsante di avviso/arresto.
5. Selezionare la modalità manuale e la temperatura di cottura facendo click su M più volte fino a quando il colore non corrisponde alla temperatura desiderata:

	85-110°C
	150-165°C
	190-205°C
	240-255°C

6. Iniziare a preriscaldare premendo il pulsante OK.
7. Una volta raggiunta la temperatura desiderata, il grill emette un segnale acustico e il processo di cottura inizia.

## 2. POSIZIONE FORNO

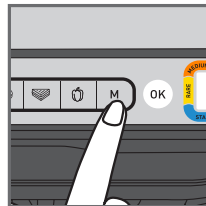

8

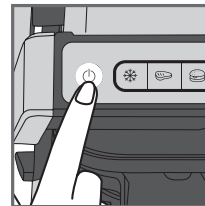

9

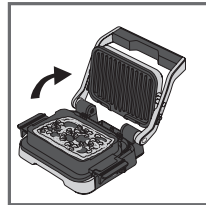

10



11

8. È possibile regolare la temperatura durante la cottura.
9. Controllare il cibo durante la cottura. Quando lo si considera cotto come desiderato, terminare la cottura premendo il pulsante di avvio/arresto. Tutti i pulsanti si spengono, il grill smette di riscaldare/ cuocere.
10. Aprire il grill e rimuovere l'accessorio da forno dal grill utilizzando le maniglie.  
**ATTENZIONE:** superfici calde, si consiglia l'uso di guanti. L'accessorio da forno è caldo, assicurarsi di appoggiarlo su una superficie adatta.
11. L'accessorio da forno può essere lavato in lavastoviglie.

### 3. POSIZIONE BARBECUE

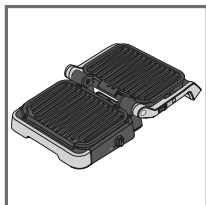

1

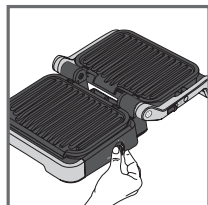

2

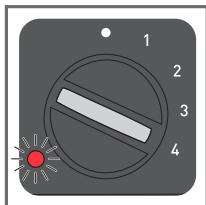

3

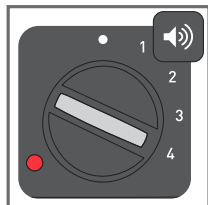

4

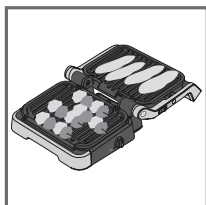

5

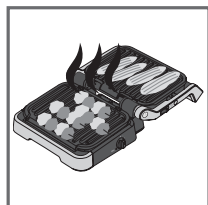

6

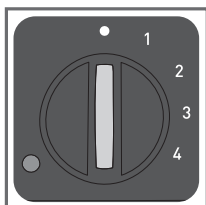

7

1. Aprire il grill in posizione barbecue. La cottura viene gestita con il termostato laterale.
2. Selezionare l'impostazione della temperatura desiderata. Il termostato imposta la stessa temperatura di cottura per entrambe le piastre:

• thermostat off
1: 80-100°C
2: 130-160°C
3: 160-190°C
4: 180-220°C

3. La spia luminosa laterale lampeggia in rosso durante il preriscaldamento.
4. Quando la spia luminosa diventa rossa fissa e il grill emette un segnale acustico, il grill è pronto per l'uso.
5. Mettere il cibo sul grill.
6. Controllare la cottura degli alimenti e rimuoverli una volta terminata.
7. Spegner l'apparecchio impostando il termostato su •.

#### Commenti:

- È possibile modificare la temperatura durante la cottura. Se viene modificata durante la cottura, il grill regolerà la temperatura in base alla nuova impostazione.
- Se si deve utilizzare una sola piastra per la cottura degli alimenti, utilizzare quella superiore.

### 4. POSIZIONE PASTO COMPLETO

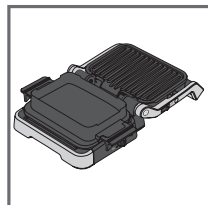

1

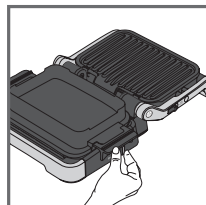

2

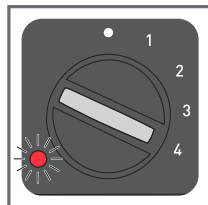

3

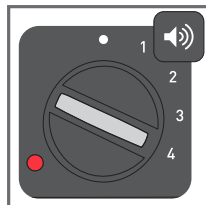

4

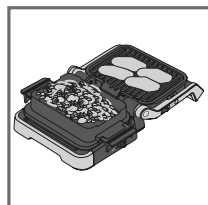

5

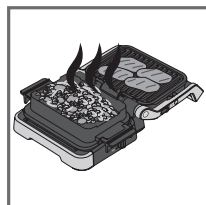

6

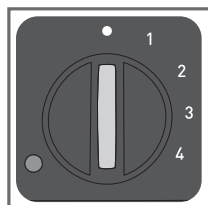

7

1. Posizionare il grill in posizione pasto completo. La cottura viene gestita con il termostato laterale.
2. Selezionare l'impostazione della temperatura desiderata. Il termostato controlla la temperatura di cottura di entrambe le piastre.

• thermostat off
1: 80-100°C
2: 130-160°C
3: 160-190°C
4: 180-220°C

3. La spia luminosa laterale lampeggia in rosso durante il preriscaldamento.
4. Quando la spia luminosa diventa rossa fissa e il grill emette un segnale acustico, il grill è pronto per l'uso.
5. Sistemare il cibo sul grill e nell'acce da forno.
6. Controllare la cottura degli alimenti e rimuoverli una volta terminata.
7. Spegner l'apparecchio impostando il termostato su •.

#### Commento:

- È possibile modificare la temperatura durante la cottura. Se viene modificata durante la cottura, il grill regolerà la temperatura in base alla nuova impostazione.

#### Suggerimenti:

Se la cottura del contorno richiede più tempo rispetto a quella dell'alimento che si sta grigliando, è anche possibile iniziare la cottura nella posizione forno. In questo caso, fare riferimento a pagina xx e seguire i passaggi da 1 a 7. Quando il cibo è cotto come desiderato, aprire il grill in posizione pasto completo. Il grill passa automaticamente al termostato laterale. Scegliere l'impostazione della temperatura desiderata utilizzando il termostato. Quando la piastra del grill si è preriscaldata, mettervi sopra gli alimenti.

## A FINE UTILIZZO

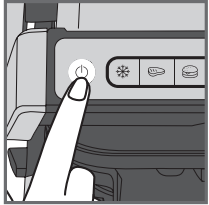

1

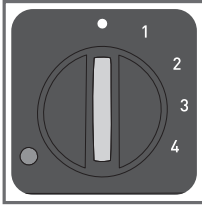

1. Spegner l'apparecchio:
  - Premere il pulsante di avvio/arresto sulla maniglia in posizione grill/forno.
  - Impostare il termostato laterale su
    - nelle posizioni barbecue/pasto completo.
2. Scollegare l'apparecchio dalla presa di corrente.
3. Lasciare raffreddare per almeno 2 ore. Per evitare ustioni accidentali, lasciare raffreddare completamente il grill prima di pulirlo.

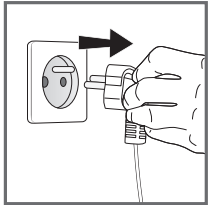

2

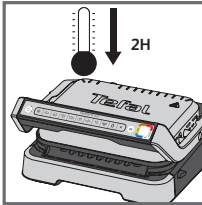

3

## PULIZIA

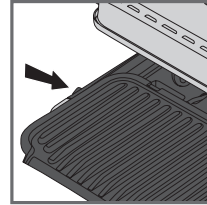

1

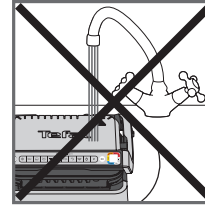

2

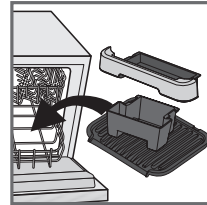

3

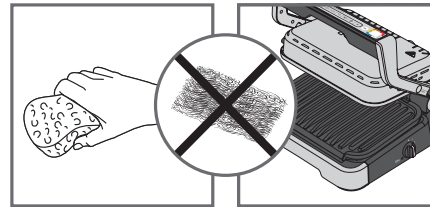

4

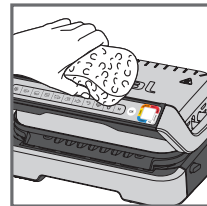

5

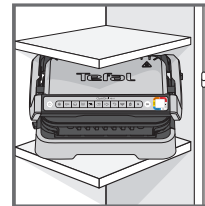

















6

1. Prima di pulire l'apparecchio, sbloccare e rimuovere le piastre, i vassoi raccogli-gocce e l'accessorio da forno per evitare di danneggiare la superficie di cottura. Scolare i vassoi raccogli-gocce e lavarli con acqua calda e sapone, quindi asciugare accuratamente con un panno di carta.
2. Non immergere il corpo del grill in acqua o in altri liquidi.
3. L'apparecchio e il cavo non possono essere messi in lavastoviglie. Gli elementi riscaldanti, le parti visibili e accessibili, non devono essere puliti dopo aver rimosso le piastre. Se sono molto sporchi, attendere che l'apparecchio si raffreddi completamente e pulirli con un panno asciutto.
4. Se non si desidera lavare le piastre di cottura, i vassoi raccogli-gocce e l'accessorio da forno in lavastoviglie, usare acqua calda e del detersivo liquido per piatti, quindi risciacquarli accuratamente per rimuovere ogni residuo. Asciugare delicatamente con un panno di carta.  
Non usare spugne abrasive o metalliche o prodotti di pulizia abrasivi per pulire l'apparecchio; usare esclusivamente spugne in nylon o non metalliche.
5. Per pulire il coperchio del grill, strofinare con una spugna bagnata e calda e asciugare con un panno morbido e asciutto.
6. Assicurarsi sempre che il grill sia pulito e asciutto prima di riporlo.

Tutte le operazioni di riparazione devono essere eseguite da un centro di assistenza autorizzato.

# Guida alla risoluzione dei problemi

Problema	Causa	Soluzione
<p>Il pulsante  lampeggia</p> <p>+  L'indicatore è acceso di blu</p> <p>+ Il pulsante  lampeggia</p>	<ul style="list-style-type: none"> <li>L'apparecchio è stato acceso o è stato avviato un ciclo di cottura automatico senza pre-riscaldamento (la modalità manuale viene attivata automaticamente).</li> </ul>	<ul style="list-style-type: none"> <li>2 possible options:               <ul style="list-style-type: none"> <li>Selezionare la temperatura premendo il pulsante  quindi premere il pulsante <b>OK</b>. Continuare la cottura ma monitorarla (modalità manuale).</li> <li>Spegnere l'apparecchio, rimuovere gli alimenti, chiudere l'apparecchio, riprogrammarlo e attendere il termine del pre-riscaldamento.</li> </ul> </li> </ul>
<p>L'apparecchio si spegne durante il pre-riscaldamento o la cottura.</p>	<ul style="list-style-type: none"> <li>L'apparecchio è rimasto aperto troppo a lungo durante la cottura.</li> <li>Non è stato premuto alcun pulsante al termine del pre-riscaldamento o del mantenimento al caldo.</li> </ul>	<ul style="list-style-type: none"> <li>Scollegare l'apparecchio dalla presa di corrente, attendere 2-3 minuti, quindi riavviare il processo. Al successivo utilizzo dell'apparecchio, assicurarsi di aprirlo e chiuderlo rapidamente per i migliori risultati di cottura. Se il problema si ripresenta, contattare il servizio clienti Tefal locale.</li> </ul>
<p> L'indicatore lampeggia di viola+ Il pulsante  /  /  /  /  lampeggia</p> <p>+ Segnale acustico intermittente</p> <p>L'apparecchio non emette segnali acustici.</p>	<ul style="list-style-type: none"> <li>Malfunzionamento dell'apparecchio.</li> <li>L'apparecchio è stato usato o conservato in un locale troppo freddo.</li> </ul>	<ul style="list-style-type: none"> <li>Scollegare e ricollegare l'apparecchio alla presa di corrente e avviare immediatamente il pre-riscaldamento. Se il problema persiste, contattare il Servizio clienti.</li> </ul>
<p> L'indicatore lampeggia di viola</p> <p>+ Il pulsante  lampeggia</p> <p>+ Segnale acustico continuo</p>	<ul style="list-style-type: none"> <li>Malfunzionamento dell'apparecchio.</li> </ul>	<ul style="list-style-type: none"> <li>Scollegare l'apparecchio dalla presa di corrente e contattare il Servizio clienti.</li> </ul>
<p>Dopo il pre-riscaldamento, gli alimenti sono stati posizionati nell'apparecchio e l'apparecchio è stato chiuso  ma l'indicatore rimane acceso di bianco e il ciclo di cottura non si avvia.</p>	<ul style="list-style-type: none"> <li>Lo spessore degli alimenti all'interno dell'apparecchio supera i 4 cm.</li> <li>La griglia non è stata aperta completamente durante il posizionamento degli alimenti.</li> <li>L'apparecchio non rileva gli alimenti al suo interno. <b>Se "OK" lampeggia, la quantità di alimenti è insufficiente.</b></li> </ul>	<ul style="list-style-type: none"> <li>Lo spessore degli alimenti non deve superare i 4 cm.</li> <li>Aprire completamente la griglia e richiuderla.</li> <li>Confermare l'attivazione del ciclo di cottura premendo il pulsante .</li> </ul>
<p>L'apparecchio si avvia in modalità manuale</p> <p>+  L'indicatore lampeggia di rosso.</p> <p>+ il pulsante di controllo della temperatura  e la spia  sono accesi</p>	<ul style="list-style-type: none"> <li>Il pre-riscaldamento è stato interrotto.</li> </ul>	<ul style="list-style-type: none"> <li>Monitorare periodicamente la cottura (modalità manuale). <b>Oppure</b></li> <li>Spegnere la griglia, rimuovere gli alimenti, chiudere la griglia, selezionare il programma di cottura desiderato e attendere il termine del pre-riscaldamento.</li> </ul>





EN	1-20
DE	21-38
NL	39-56
FR	57-74
IT	75-92