

# Tefal®

EN

TH

VI

MS

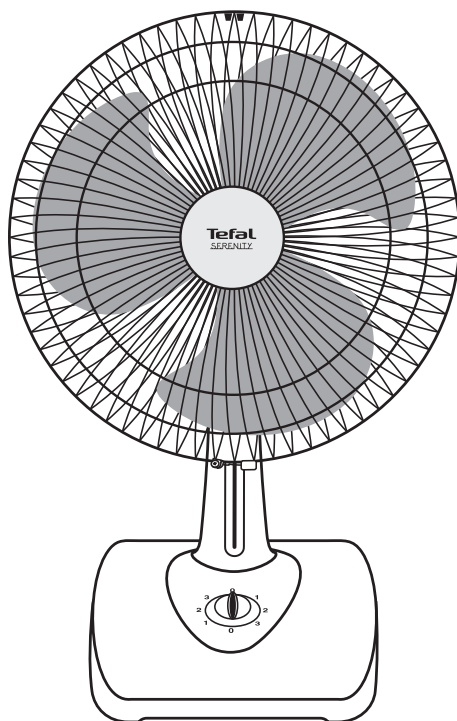

## DESK FAN

TH • พัดลมตั้งโต๊ะ VI • Quạt Bàn MS • Kipas Meja  
VU35xx

[www.tefal.com](http://www.tefal.com)

410000082/01

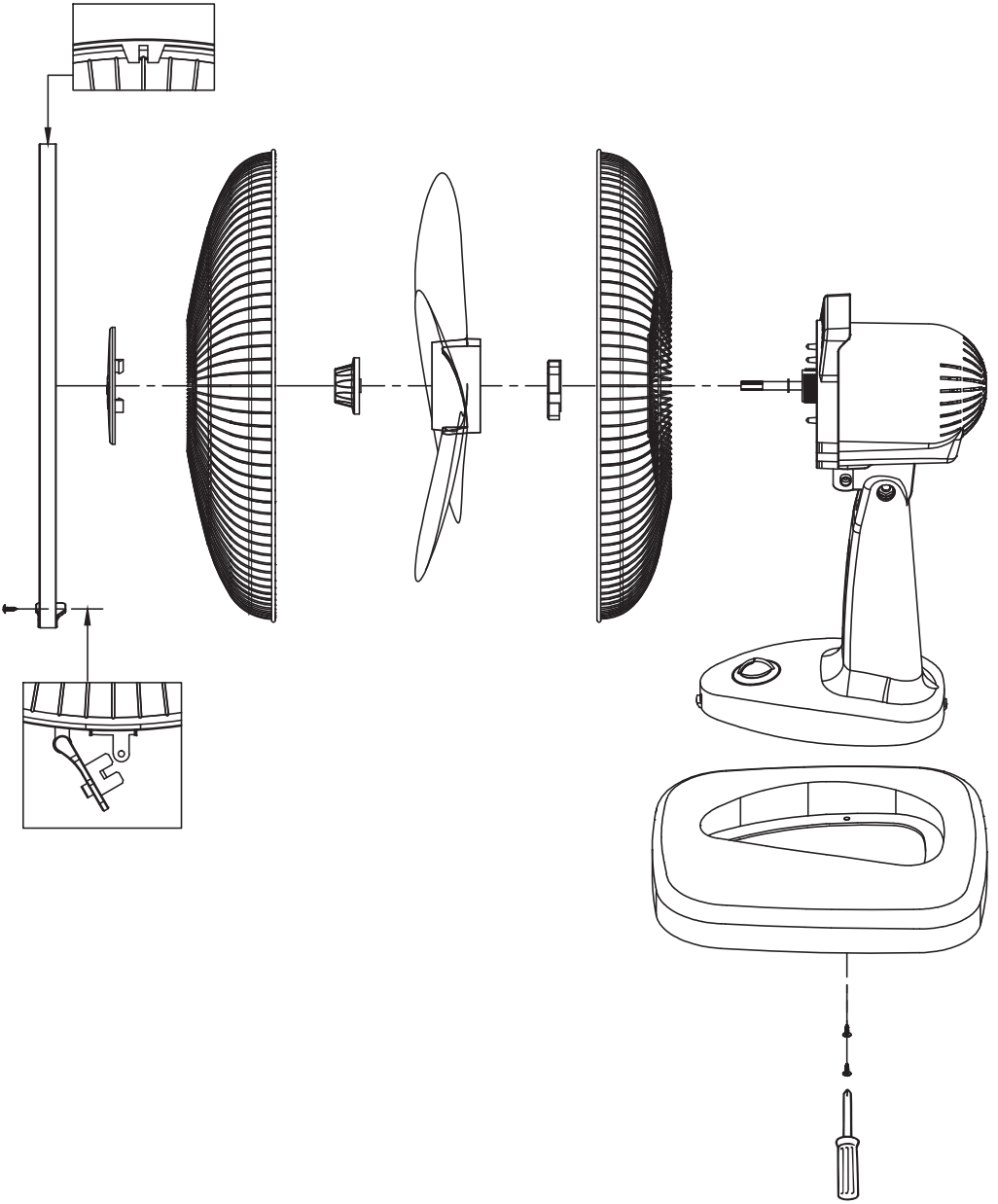

## 1 - WARNINGS

It is essential that you read these instructions carefully and comply with the following recommendations.

- This appliance is not intended for use by persons (including children) with reduced physical, sensory or mental capabilities, or lack of experience and knowledge, unless they have been given supervision or instruction concerning use of the appliance by a person responsible for their safety. Children should be supervised to ensure that they do not play with the appliance.

- This appliance can be used by children aged from 8 and above and persons with reduced physical, sensory or mental capabilities or lack of experience and knowledge if they have been given supervision or instruction concerning the use of the appliance in a safe way and understand the hazards involved. Children shall not play with the appliance. Cleaning and user maintenance shall not be made by children without supervision.

- For your safety, this appliance complies with the applicable standards and regulations (Low Voltage Directive, Electromagnetic Compatibility, Environmental...).

- Before using, always check the condition of the appliance, the power socket and the power lead.
- Do not pull on the power cable or the appliance, even to unplug it from the wall socket.
- Never insert objects into the appliance (e.g. needles...).
- Do not use your appliance in a dusty room or a room where there is a risk of fire.
- This appliance is intended for domestic use only. It must therefore not be used in industrial applications.
- The warranty will be void in the event of damage arising from improper use.
- If the power cable is damaged, it must be replaced by the manufacturer, its after-sales service or a person with similar qualifications to avoid any danger.

## 2 - VERY IMPORTANT

- Keep the appliance 50 cm away from any objects (curtains, walls, aerosols, etc.)
- NEVER ALLOW WATER TO PENETRATE THE APPLIANCE.
- Do not touch the appliance with wet hands.
- Before operating, please ensure that :
  - The appliance is assembled according to the manufacturers instructions.
  - The appliance is placed on a stable and firm surface
  - The appliance is in a normal operating position (in an upright position on its feet).
- This appliance must not be used in a damp room.

## 3 - VOLTAGE

- Before using for the first time, check that the voltage of your mains supply is the same as that shown on the appliance and that your mains supply is suitable for the power indicated on the appliance.
- Your appliance can be used with a power plug without an earth connection. It is a class II appliance (dual electrical insulation).

## 4 - ASSEMBLING

- Your appliance is supplied unassembled. For your safety, it is essential to assemble it correctly.
- You must set and use your appliance in compliance with the standards in force in your country.

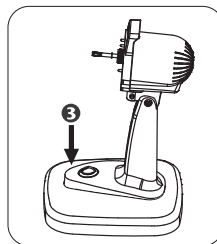
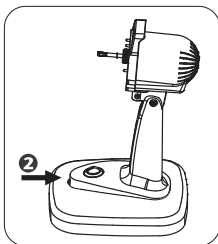
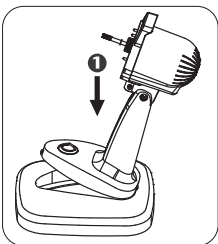

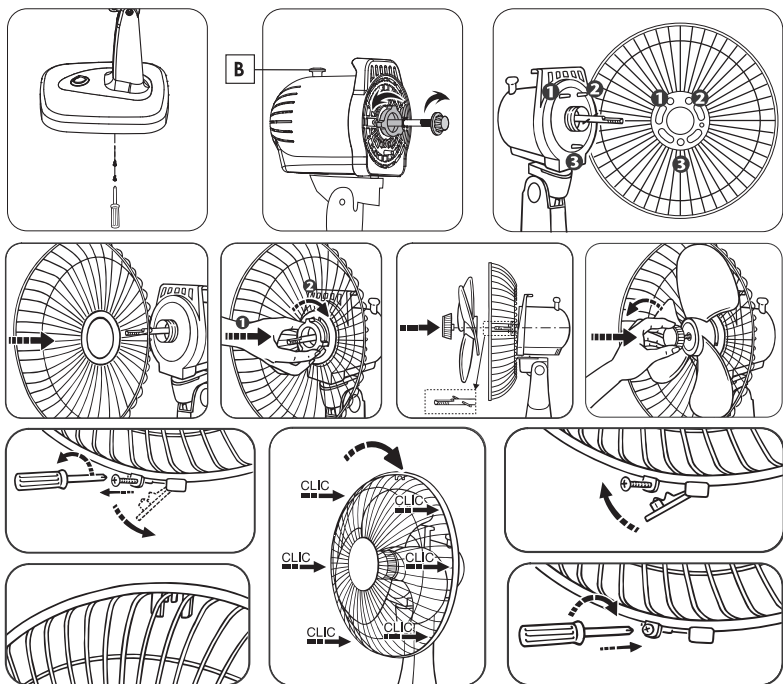

## 5 - OPERATION

**CAUTION :** Do not try to raise the button (B) when the appliance is in use, as you could damage the oscillation mechanism.

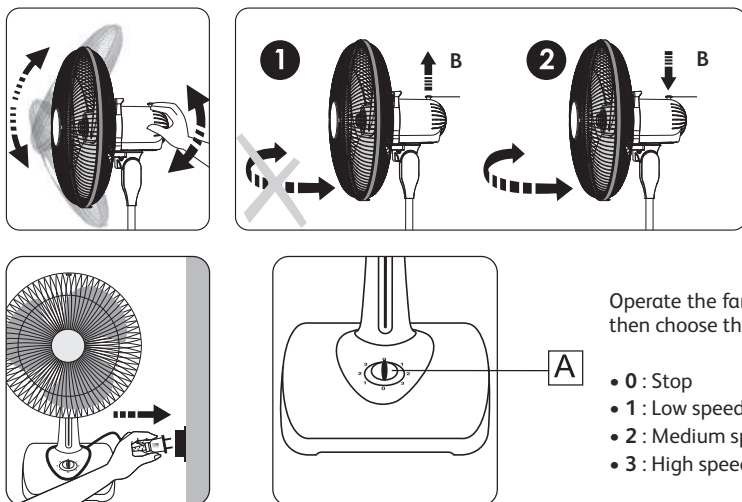

Operate the fan using the button (A), then choose the speed you require

- 0 : Stop
- 1 : Low speed
- 2 : Medium speed
- 3 : High speed

Then turn the button (A) on the position 0 to stop the fan.

### IMPORTANT:

We advise you to unplug your appliance when it is not in use.

## 6 - CLEANING

- Your appliance must be unplugged before proceeding with any cleaning work.
- You can clean it with a slightly damp cloth.

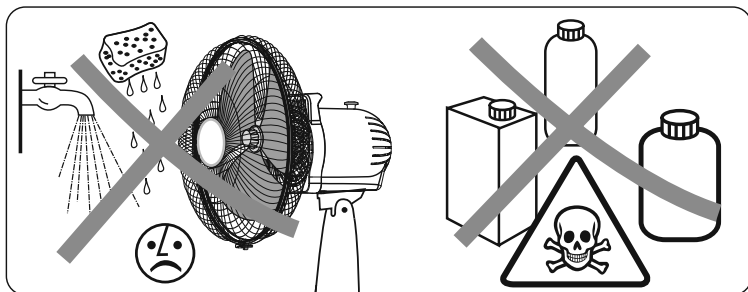
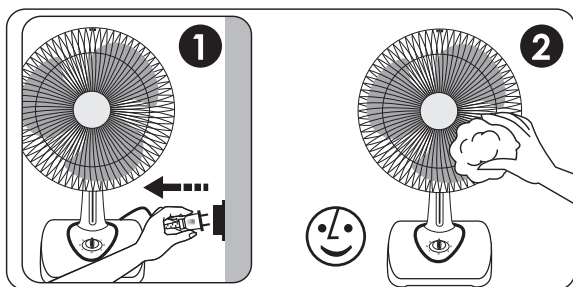

- **IMPORTANT:** Never use abrasive products which might damage the appearance of your appliance.

## 7 - STORAGE

- When you are not using your appliance, store it in a dry place.

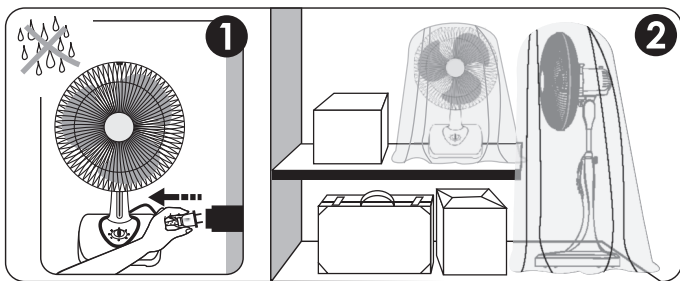

## 8 - IN THE EVENT OF PROBLEMS

- Never dismantle your appliance yourself. A poorly repaired appliance may be dangerous for the user.
- If the appliance ceases to operate or is damaged in any way, contact one of our authorised service centres.

## 9 - ENVIRONMENT PROTECTION FIRST !



- ① Your appliance contains valuable materials which can be recovered or recycled.
- ➡ Leave it at a local civic waste collection point.

## 1. คำเตือน

กรุณาอ่านคำแนะนำต่อไปนี้อย่างละเอียด และปฏิบัติตามอย่างเคร่งครัด

ผู้พิการ (ทั้งทางร่างกายและจิตใจ) และเด็ก ไม่เหมาะสำหรับการใช้เครื่องนี้เพียงลำพัง ควรมีผู้ดูแลอย่างใกล้ชิด และควรหลีกเลี่ยงไม่ให้เด็กเล่นกับเครื่อง

• ผู้ใช้งานผลิตภัณฑ์นี้ ควรมีอายุมากกว่า 8 ปีขึ้นไป กรณีผู้พิการ จะต้องมีผู้ดูแล ที่จะช่วยป้องกันอันตรายที่อาจจะเกิดขึ้นได้ ห้ามเด็กทำความสะอาด หรือบำรุงรักษาเครื่องเพียงลำพัง

- ใช้ผลิตภัณฑ์ให้ตรงกับที่มาตรฐานกำหนด (ไฟฟ้า ความตุงค์ย สิ่งแวดล้อม) เพื่อความปลอดภัย
- ตรวจสอบตัวเครื่อง ปลั๊กไฟ และสายไฟทุกครั้งก่อนการใช้งาน
- ห้ามดึงสายไฟ หรือตัวเครื่อง ถึงแม้ว่าจะถอดปลั๊กออกจากเต้ารับที่กำแพงแล้ว
- ห้ามยื่นวัสดุใดๆ เข้าไปในเครื่อง (เช่น เข็ม)
- ไม่ใช้งานผลิตภัณฑ์ในห้องที่มีฝุ่นเยอะ หรือห้องที่มีความเสี่ยงจะเกิดไฟลุกได้
- ผลิตภัณฑ์นี้ เหมาะสำหรับใช้งานในครัวเรือนเท่านั้น ไม่สามารถใช้งานในอุตสาหกรรมได้
- การใช้งานอย่างผิดวิธี จะทำให้ผลิตภัณฑ์อยู่นอกเหนือเงื่อนไขการรับประกันสินค้า
- หากสายไฟขาด จะต้องเปลี่ยนโดยบริษัท หรือจากช่างที่ได้รับการรับรองจากบริษัทเท่านั้น เพื่อป้องกันอันตรายที่อาจเกิดขึ้น

## 2. คำแนะนำ

- ตั้งเครื่องให้ห่างจากวัตถุต่างๆ 50 เซนติเมตร (เช่น ผ้าม่าน กำแพง ฯลฯ)
- ห้ามให้เครื่องสัมผัสกับน้ำ
- ห้ามใช้มือเปียกสัมผัสเครื่อง
- ก่อนการใช้งาน โปรดตรวจสอบดังนี้
  - เครื่องได้ประกอบตามคำแนะนำอย่างถูกต้อง
  - ติดตั้งเครื่องบนพื้นผิวเรียบ และมั่นคง
  - วางเครื่องในตำแหน่งที่ถูกต้อง (ในแนวตั้งขึ้นจากรฐาน)
- ไม่ใช้เครื่องในห้องที่มีอากาศชื้น

## 3. ไฟฟ้า

- ตรวจสอบความต่างศักย์ไฟฟ้า (Voltage) ของเต้าเสียบให้ตรงกับที่เครื่องต้องการ
- คุณสามารถใช้งานเครื่องได้โดยไม่ต้องต่อสายดิน

## 4. การประกอบเครื่อง

- กรุณาประกอบเครื่องให้ถูกต้องตามขั้นตอน เพื่อความปลอดภัยของคุณ
- ติดตั้ง และใช้งานเครื่องตามมาตรฐานที่กฎหมายของประเทศคุณกำหนด

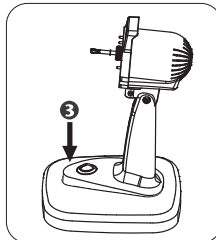
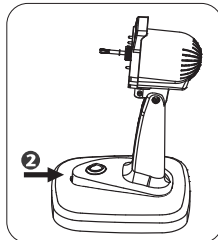
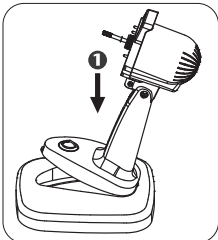

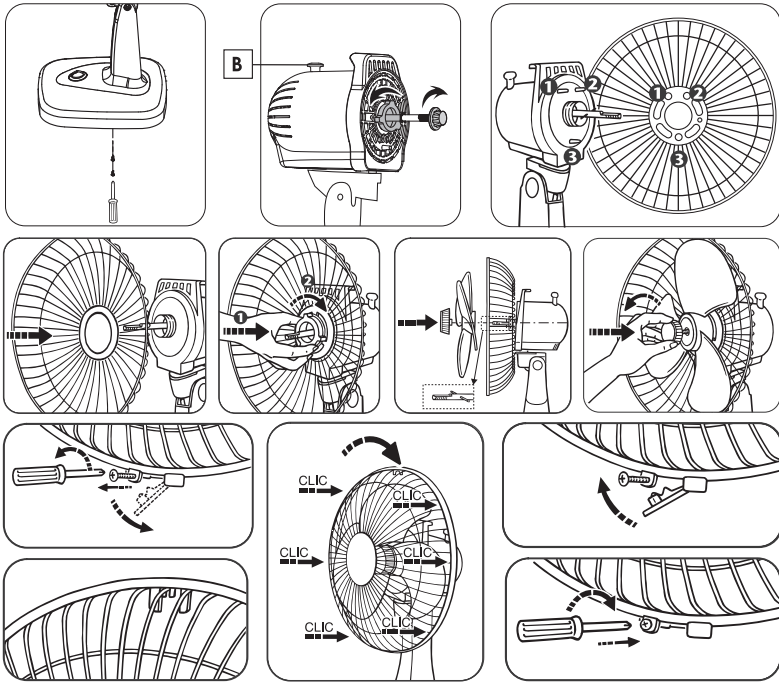

## 5. การใช้งาน

ข้อควรระวัง ห้ามดึงส่วน B ในขณะที่เครื่องกำลังทำงาน เพราะจะทำให้ระบบสายของพัดลมเสียได้

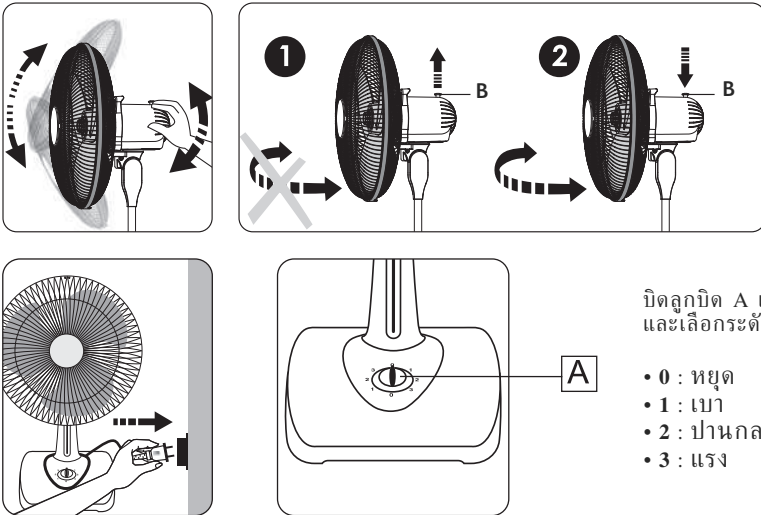

บิดลูกบิด A เพื่อเริ่มการทำงาน และเลือกระดับความแรง

- 0 : หยุด
- 1 : เบา
- 2 : ปานกลาง
- 3 : แรง

บิดลูกบิด A ไปที่ตำแหน่ง 0 เพื่อหยุดการทำงาน

คำแนะนำ  
ควรถอดปลั๊กออกเมื่อไม่ใช้งาน

## 6. การทำความสะอาด

- ถอดปลั๊กออกทุกครั้ง เมื่อต้องการทำความสะอาด
- ใช้ผ้าชุบน้ำหมาดๆ ทำความสะอาด

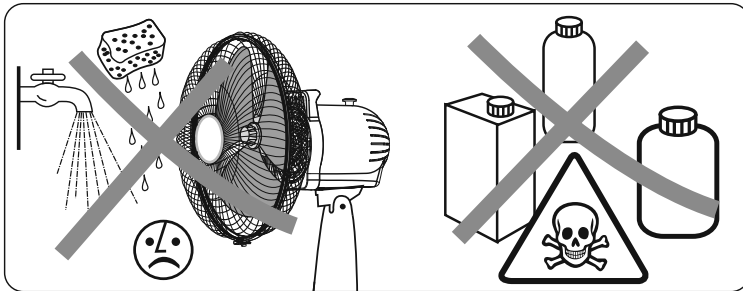
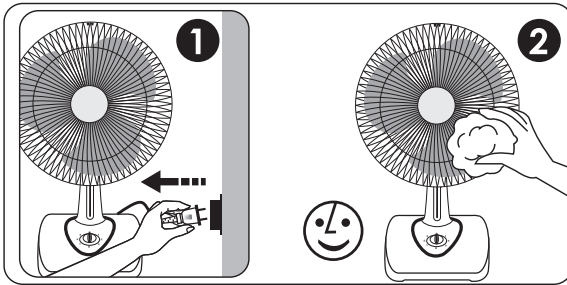

- คำเตือน ห้ามใช้สารที่มีฤทธิ์กัดกร่อนทำความสะอาด เพราะอาจทำลายความสวยงามของตัวเครื่อง

## 7. การจัดเก็บ

- เก็บเครื่องในที่แห้ง เมื่อไม่ใช้งาน

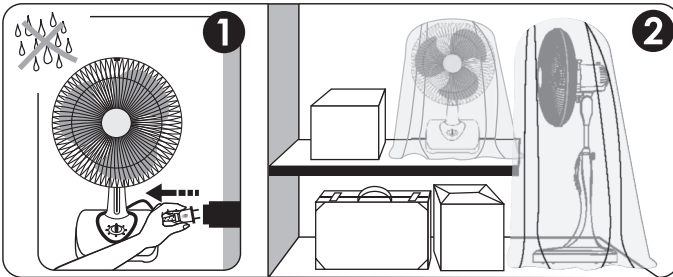

## 8. ข้อปฏิบัติเมื่อเครื่องมีปัญหา

- ห้ามแกะเครื่อง และซ่อมแซมด้วยตัวเอง เพราะอาจเกิดอันตรายได้
- หากเครื่องไม่ทำงาน กรุณาติดต่อตัวแทนที่ได้รับอนุญาตจากบริษัท

## 9. ข้อปฏิบัติเมื่อเครื่องมีปัญหา

- ❌ ① ชิ้นส่วนต่างๆ ของผลิตภัณฑ์นี้ สามารถนำไปรีไซเคิลได้



## 1 – CẢNH BÁO

Bạn cần đọc kỹ những hướng dẫn và thực hiện theo những lời chỉ dẫn sau đây:

- Thiết bị này không dành để sử dụng đối với những người (kể cả trẻ em) bị suy giảm về thể chất, giác quan hoặc tâm thần, hoặc thiếu kinh nghiệm về kiến thức, trừ khi họ chịu trách nhiệm về sự an toàn hoặc có người giám sát chỉ dẫn để sử dụng thiết bị.
- Trẻ em nên được giám sát để đảm bảo rằng chúng không nghịch phá với thiết bị này. Thiết bị này có thể dùng bởi trẻ em từ 8 tuổi trở lên và người giảm thể chất, khả năng giác quan hoặc tâm thần hoặc thiếu kinh nghiệm và kiến thức nếu họ được giám sát hoặc được hướng dẫn sử dụng thiết bị một cách an toàn và hiểu rõ được những tác hại nguy hiểm của nó. Trẻ con không được chơi với thiết bị này. Trẻ em không được tự làm vệ sinh và tự bảo trì máy khi không có sự giám sát của người lớn.
- Vì sự an toàn của bạn, thiết bị này phải phù hợp với các tiêu chuẩn và các quy định đã được định sẵn (điện áp thấp, độ tương thích điện từ, môi trường...).
- Trước khi sử dụng, luôn luôn kiểm tra tình trạng của các thiết bị, ổ cắm điện và bộ phận dẫn điện.
- Không kéo dây cáp điện hoặc thiết bị điện, thậm chí rút phích cắm ra khỏi ổ cắm điện.
- Không được chèn các vật dụng khác vào thiết bị (ví dụ như kim...).
- Không sử dụng thiết bị trong phòng đầy bụi hoặc nơi có khả năng cháy nổ cao.
- Thiết bị này được thiết kế chỉ để dùng làm hàng gia dụng. Do đó, nó không được sử dụng để ứng dụng trong công nghiệp.
- Việc bảo hành sẽ không có giá trị nếu trường hợp thiệt hại phát sinh từ việc bạn sử dụng không đúng cách.
- Nếu các dây cáp điện bị hư hỏng, nó phải được thay sửa bởi Trung Tâm Dịch Vụ Bảo Hành hoặc người có tay nghề trong lĩnh vực, để tránh gây ra bất kỳ trường hợp nguy hiểm nào.

## 2 – LƯU Ý RẤT QUAN TRỌNG

- Để thiết bị cách xa các đối tượng khoảng 50 cm (màn cửa, tường, bình xịt...)
- **KHÔNG BAO GIỜ ĐỂ CHO NƯỚC THÂM NHẬP VÀO THIẾT BỊ.**
- Không chạm tay vào thiết bị khi tay còn ướt.
- Trước khi khởi động phải đảm bảo rằng:
  - Thiết bị này được lắp ráp theo hướng dẫn của nhà sản xuất.
  - Thiết bị được đặt trên một bề mặt ổn định và vững chắc.
  - Thiết bị hoạt động ở vị trí bình thường (vị trí thẳng đứng trên đế bàn của thiết bị).
- Thiết bị này không được sử dụng trong phòng ẩm thấp.

## 3 – ĐIỆN ÁP

- Trước khi sử dụng lần đầu tiên, kiểm tra xem thiết bị xem điện áp của nguồn điện cung cấp có giống với hiển thị trên thiết bị hay không và nguồn điện cung cấp cho thiết bị có phù hợp không.
- Thiết bị của bạn có thể được sử dụng với một phích cắm điện mà không có kết nối với đất. Nó là một lớp 2 thiết bị (cách điện đôi).

## 4 – LẮP RÁP

- Thiết bị của bạn chưa được lắp ráp hoàn chỉnh, vì sự an toàn của bạn, nó cần được lắp ráp một cách chính xác.
- Bạn cần thiết lập và sử dụng thiết bị của bạn phù hợp với các tiêu chuẩn đã được ban hành tại Quốc gia của bạn.

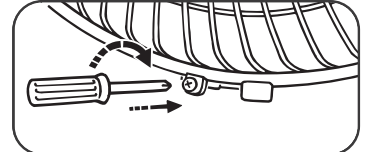
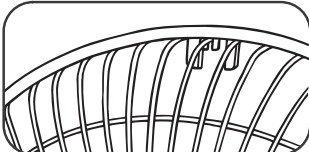
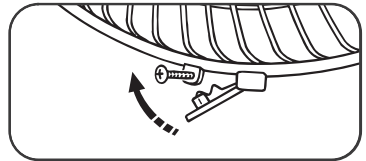
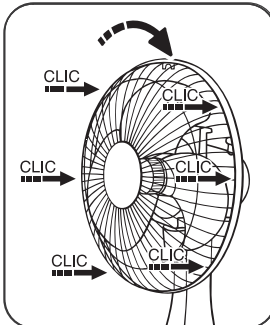
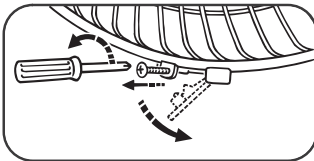
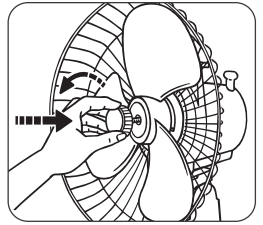
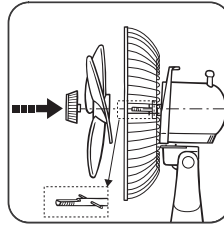
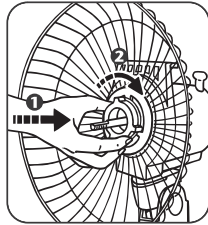
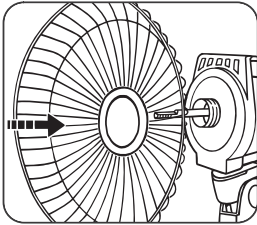
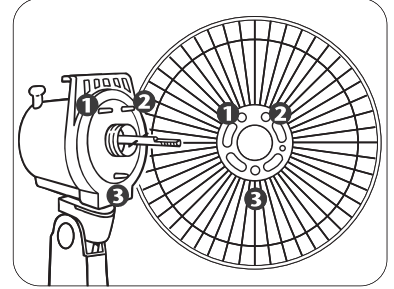
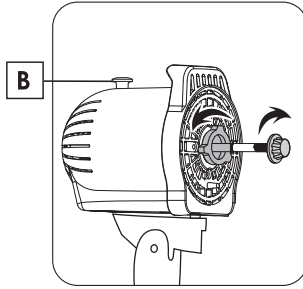
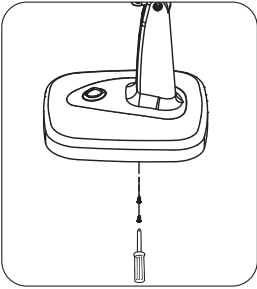
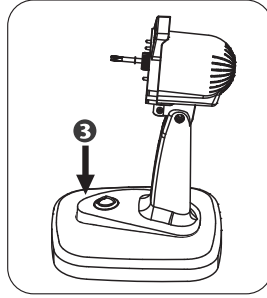
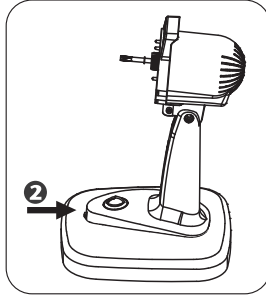
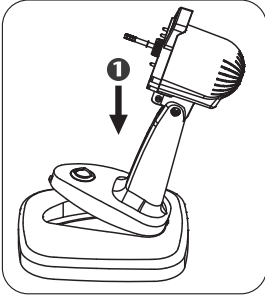

## 5 – KHỞI ĐỘNG

**THẬN TRỌNG:** Đừng thử nâng cao nút (B) khi thiết bị đang khởi động, như vậy bạn có thể gây tổn hại đến cơ chế dao động.

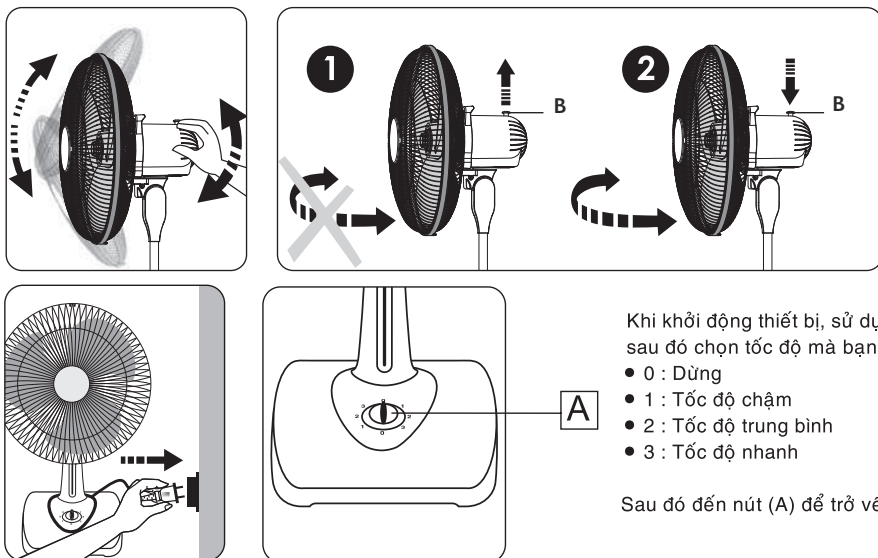

VI

## LƯU Ý QUAN TRỌNG:

Chúng tôi khuyên bạn nên rút phích cắm điện ra khi thiết bị không được sử dụng.

## 6 – VỆ SINH THIẾT BỊ

- Thiết bị của bạn phải được gỡ phích cắm điện trước khi tiến hành vệ sinh quạt.
- Bạn có thể làm sạch quạt bằng một miếng vải ướt.

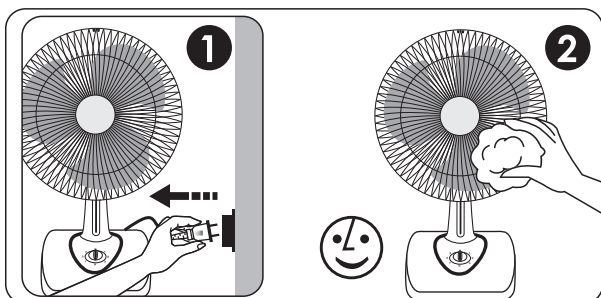

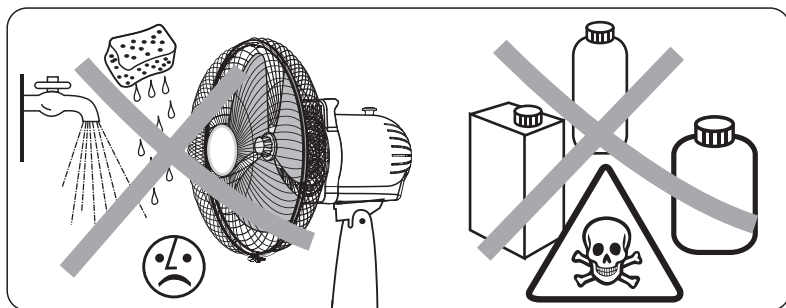

**• LƯU Ý :**

Không được sử dụng các sản phẩm mài mòn vì có thể làm hư hại thiết bị của bạn.

**7 – SẮP ĐẶT THIẾT BỊ**

• Khi bạn không sử dụng thiết bị, hãy đặt nó ở nơi khô thoáng.

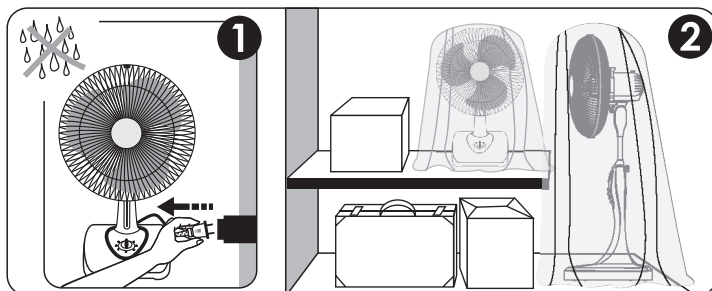

**8 – NHỮNG VẤN ĐỀ LƯU Ý**

- Không bao giờ tháo gỡ bỏ các linh kiện của bạn, Một thiết bị sửa chữa kém có thể gây ra nguy hiểm cho người sử dụng.
- Nếu thiết bị không còn hoạt động được nữa hoặc bị hư hại ở bất cứ bộ phận nào, hãy liên hệ với Trung Tâm Dịch Vụ Bảo Hành đã được ủy quyền của chúng tôi.

**9 – BẢO VỆ MÔI TRƯỜNG LÀ TRÊN HẾT!**

Thiết bị này có chứa những vật liệu quý có thể được tái sử dụng hoặc tái chế lại. Hãy bỏ nó ở những điểm thu thập rác thải dân dụng tại địa phương.



## 1 - AMARAN

Anda perlu membaca arahan ini dengan teliti dan mematuhi syor berikut.

• Alat ini bukan bertujuan digunakan oleh individu (termasuk kanak-kanak) yang mempunyai kekurangan keupayaan fizikal, deria atau mental, atau kekurangan pengalaman dan pengetahuan, melainkan mereka diberi pengawasan atau arahan berkaitan penggunaan alat oleh individu yang bertanggungjawab terhadap keselamatan mereka. Kanak-kanak perlu diawasi bagi memastikan mereka tidak bermain dengan alat.

• Alat ini boleh digunakan oleh kanak-kanak berumur 8 tahun dan ke atas dan oleh mereka dengan kekurangan keupayaan fizikal, deria atau mental, atau kekurangan pengalaman dan pengetahuan jika mereka menerima pengawasan atau arahan berkaitan penggunaan alat secara selamat dan memahami bahaya yang terlibat. Kanak-kanak tidak boleh bermain dengan alat. Pembersihan dan penyelenggaraan oleh pengguna tidak boleh dilakukan oleh kanak-kanak tanpa pengawasan.

• Untuk keselamatan anda, alat ini mematuhi piawaian dan peraturan yang terpakai (Arahan Voltan Rendah, Keperluan Elektro Magnetik, Alam Sekitar...)

• Sebelum penggunaan, sentiasa periksa keadaan alat, soket kuasa dan kabel elektrik.

• Jangan tarik kabel elektrik atau alat, walaupun untuk mencabutnya daripada soket dinding.

• Jangan selitkan objek ke dalam alat (contohnya jarum...).

• Jangan gunakan alat ini di dalam bilik yang berhabuk atau di dalam bilik yang terdapat risiko kebakaran.

• Alat ini adalah untuk kegunaan domestik sahaja. Oleh itu alat ini tidak boleh digunakan untuk aplikasi industri.

• Jaminan akan dibatalkan sekiranya kerosakan berlaku akibat penggunaan yang salah.

• Jika kabel kuasa rosak, ia perlu diganti oleh pembuat, pembekal servis selepas jualan atau individu dengan kepakaran yang sama untuk mengelakkan sebarang bahaya.

MS

## 2 - SANGAT PENTING

• Alat perlu berada 50 cm jauh daripada sebarang objek (langsir, dinding, aerosol dan sebagainya)

• **JANGAN BIARKAN AIR MEMASUKI ALAT.**

• Jangan pegang alat dengan tangan yang basah.

• Sebelum operasi, sila pastikan:

- Alat ini dipasang mengikut arahan pembuat

- Alat diletakkan di atas permukaan yang stabil dan tetap.

- Alat berada pada kedudukan operasi yang biasa (kedudukan menegak pada tapaknya).

• Alat ini tidak boleh digunakan di dalam bilik yang lembap.

## 3 - VOLTAN

• Sebelum menggunakan alat ini buat kali pertama, pastikan voltan bekalan elektrik anda sama dengan yang ditunjukkan pada alat dan bekalan elektrik anda sesuai dengan kuasa yang ditunjukkan pada alat.

• Alat anda boleh digunakan dengan palam kuasa tanpa sambungan bumi. Ia adalah alat kelas II (penebat elektrik berkembar).

## 4 - PEMASANGAN

• Alat anda dibekalkan tanpa pemasangan. Untuk keselamatan anda, adalah penting untuk memasangkannya dengan betul.

• Anda perlu memasang dan menggunakan alat anda dengan mematuhi piawaian yang dikuatkuasakan di negara anda.

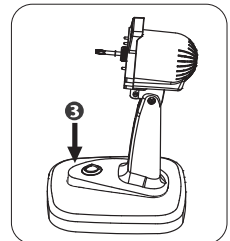
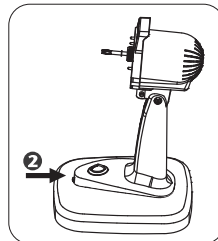
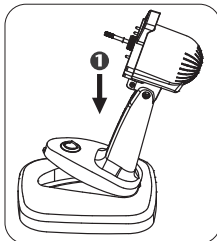

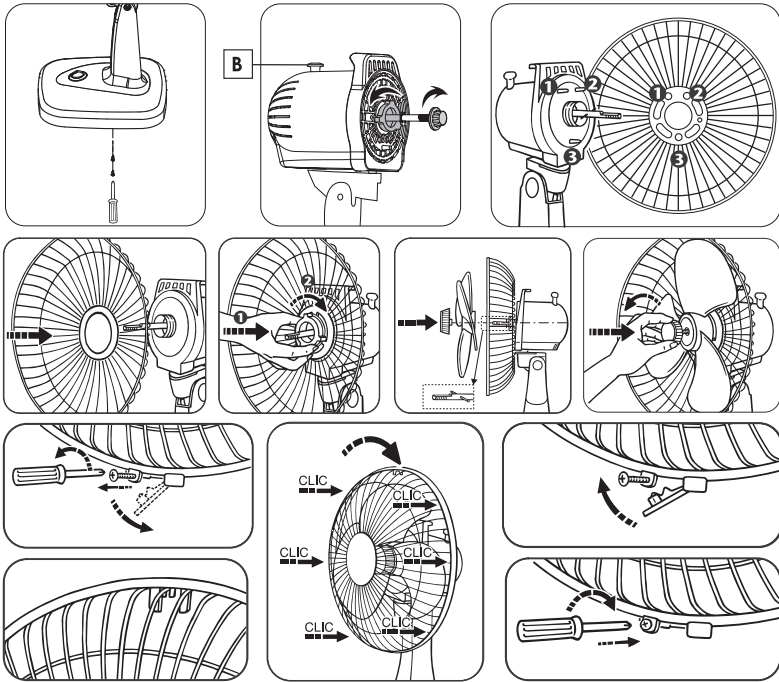

## 5 - OPERASI

**PERINGATAN:** Jangan cuba meningkatkan butang (B) semasa alat sedang digunakan kerana anda boleh merosakkan mekanisme ayunan.

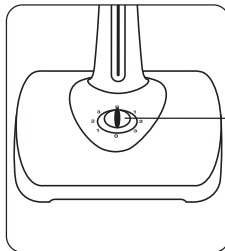
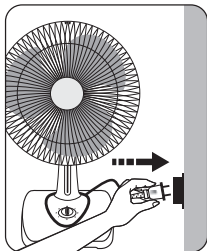
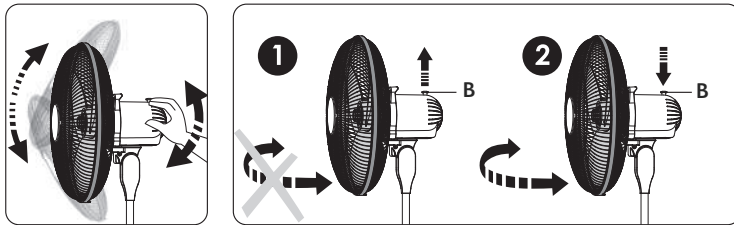

Kendalikan kipas menggunakan butang (A), kemudian pilih kelajuan yang anda mahu:

- 0 : Berhenti
- 1 : Kelajuan rendah
- 2 : Kelajuan sederhana
- 3 : Kelajuan tinggi

Kemudian pusing butang (A) kepada kedudukan 0 untuk menghentikan kipas.

### PENTING:

Kami menasihatkan anda untuk mencabut palam kuasa alat anda apabila tidak digunakan.

## 6 - PEMBERSIHAN

- Palam alat anda perlu dicabut sebelum memulakan sebarang kerja pembersihan.
- Anda boleh membersihkannya menggunakan kain yang agak lembap.

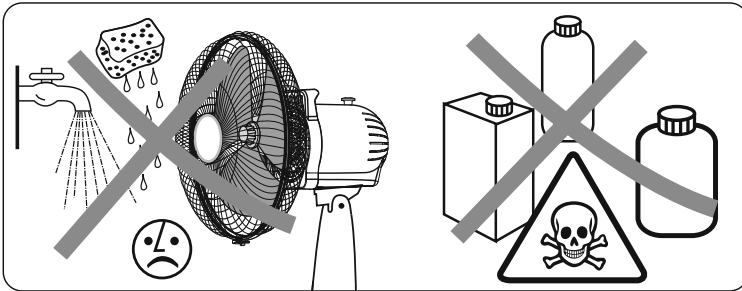
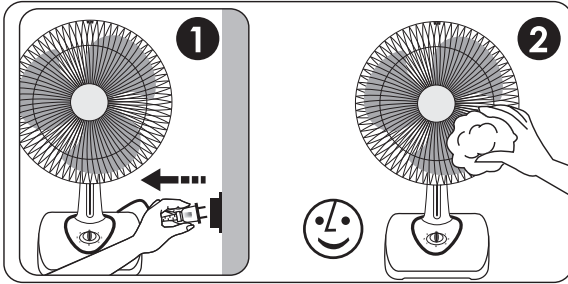

- **PENTING:** Jangan gunakan produk menghakis yang boleh merosakkan penampilan alat anda.

## 7 - PENYIMPANAN

- Simpan alat anda di tempat yang kering apabila anda tidak menggunakannya.

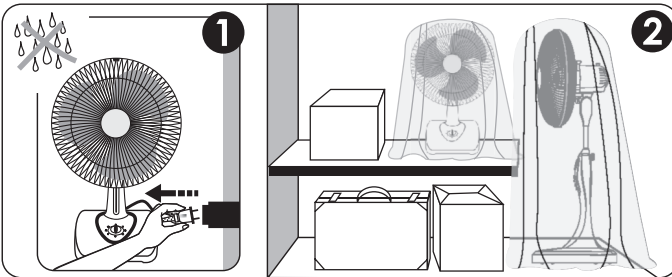

## 8 - SEKIRANYA BERLAKU MASALAH

- Jangan buka sendiri alat anda. Alat yang tidak dibaiki dengan betul boleh membahayakan pengguna.
- Jika alat tidak boleh beroperasi atau rosak dalam apa jua cara, hubungi mana-mana pusat servis kami yang sah.

## 9 - ENVIRONMENT PROTECTION FIRST !



- Alat anda mengandungi bahan-bahan berharga yang boleh dibuka atau diktarkan semula. Tinggalkannya di pusat pungutan sisa awam tempatan.