

Tefal[®]

Simply Invents

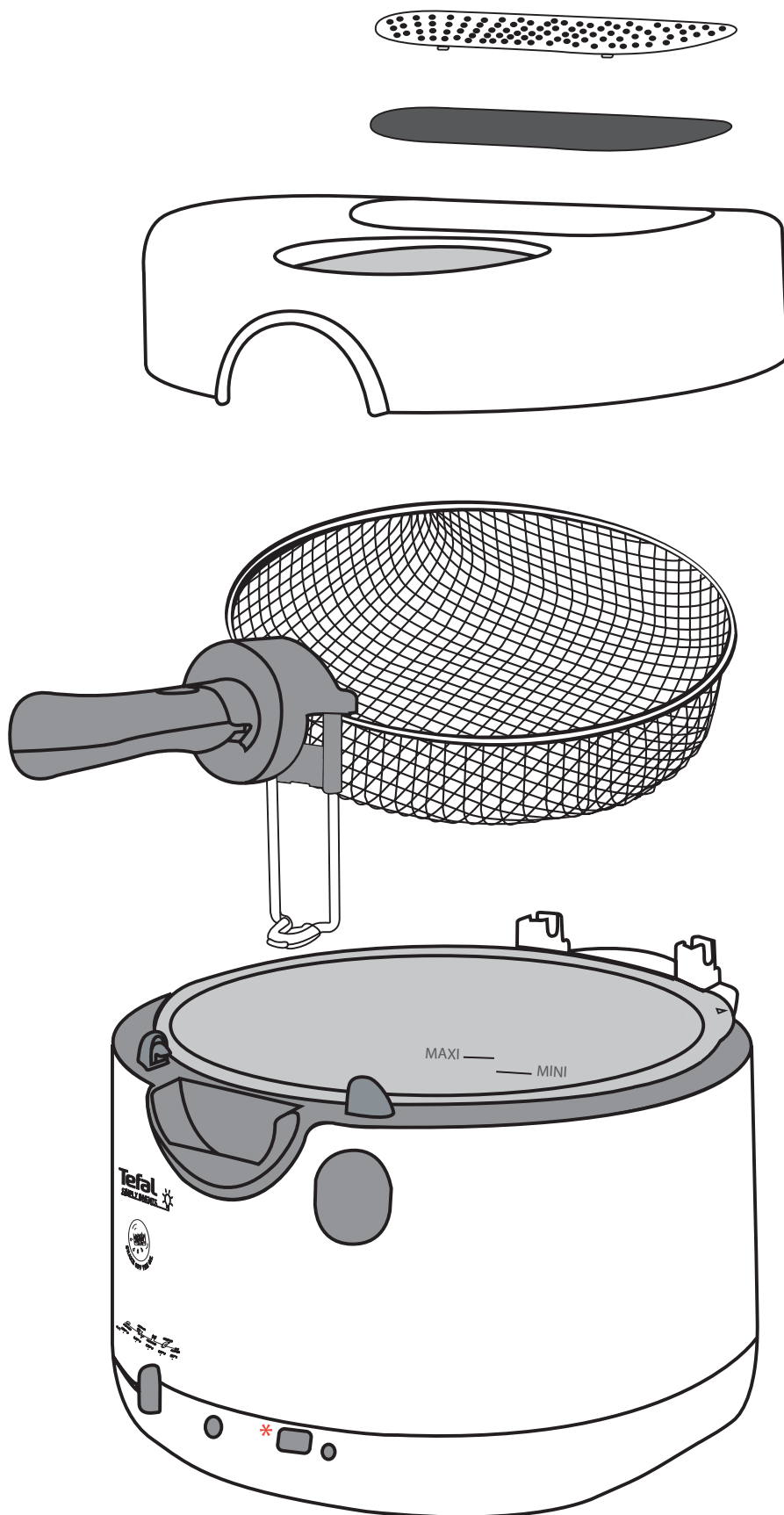



* selon modèle, depending on model, je nach Modell, niet op alle modellen aanwezig, a seconda del modello, según modelo, conforme o modelo, bazı modellerde, afhængig af model, beroende på modell, kun på noen modeller, mallista riippuen, ανάλογα με το μοντέλο, в зависимости от модели, w zależności od modelu, podle modelu, podl'a modelu, modelltöl fúggæn, според модела, حسب الموديل

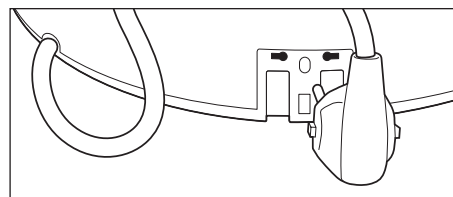

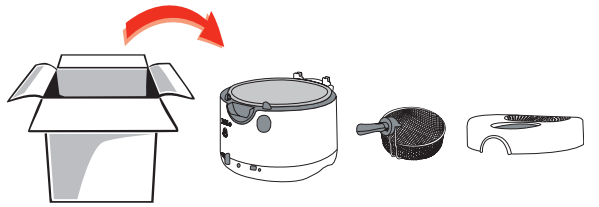

1

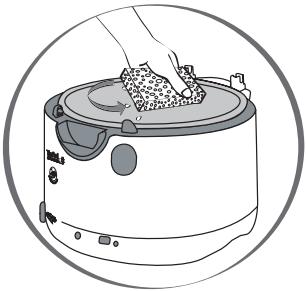
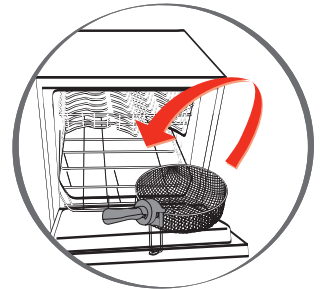
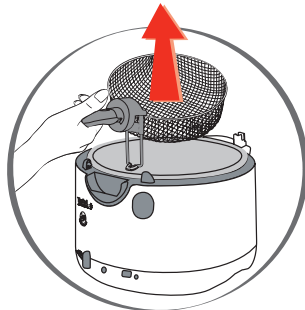
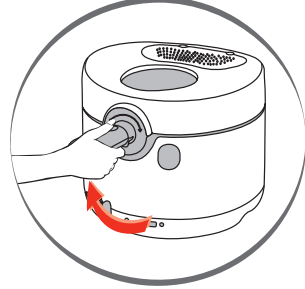
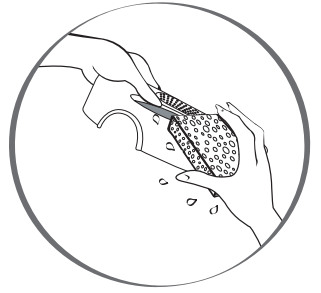
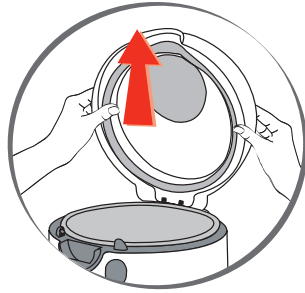
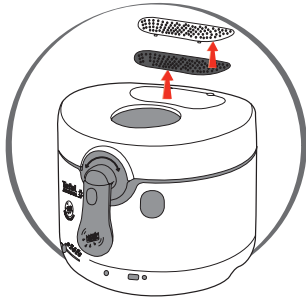

2

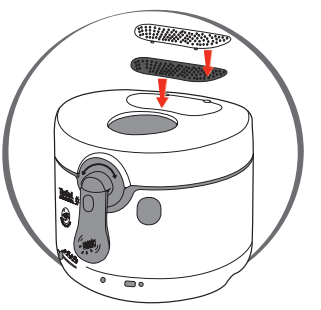
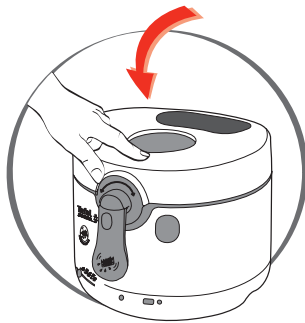
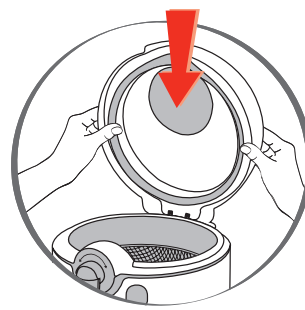
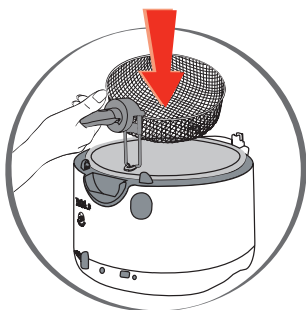



3

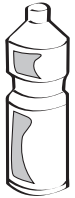

Min.
↓
Max.

2 L

2,2 L

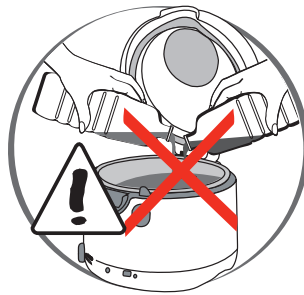
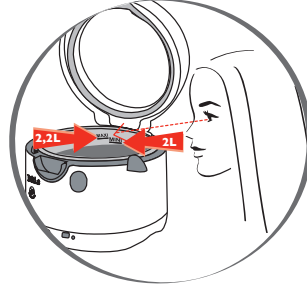
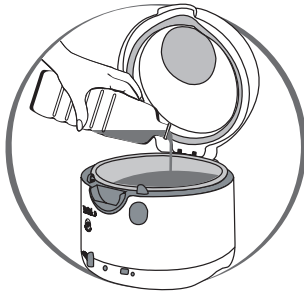

4



Min. 1750 g

↓
Max. 2000 g

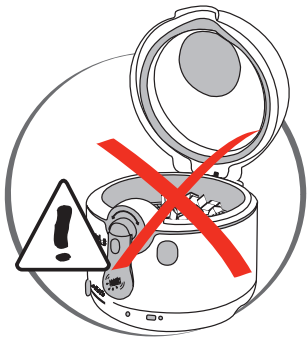
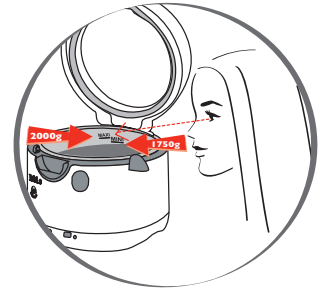
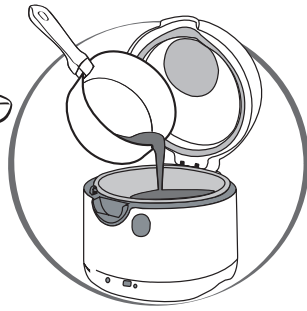
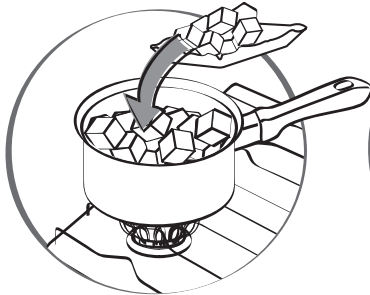

4



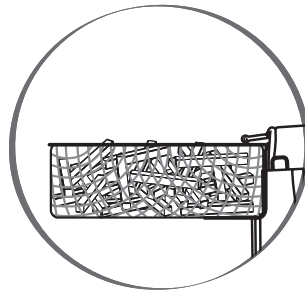

5

Max.	1200 g
	600 g



6

****	
Max.	900 g
	450 g

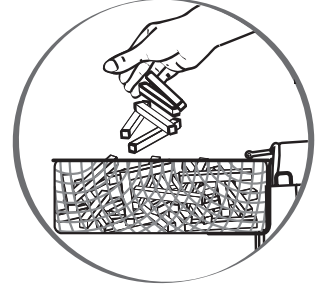
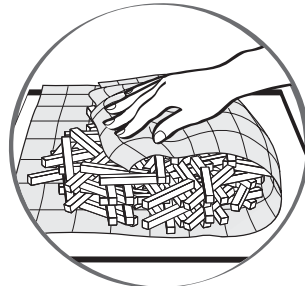
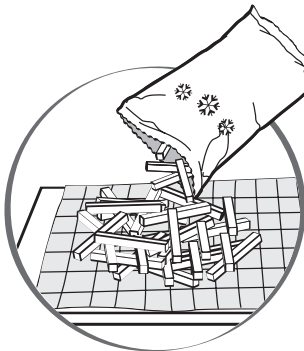

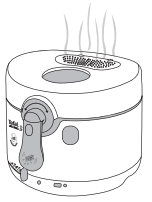

7

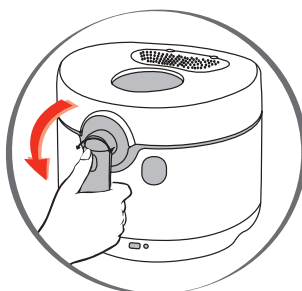
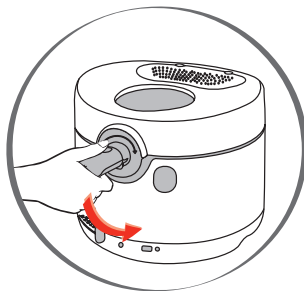
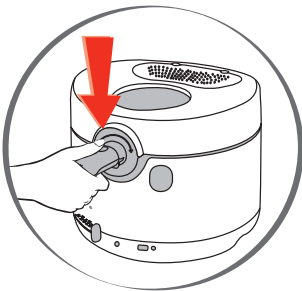
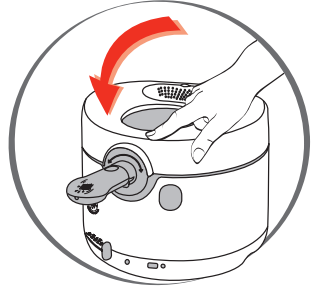
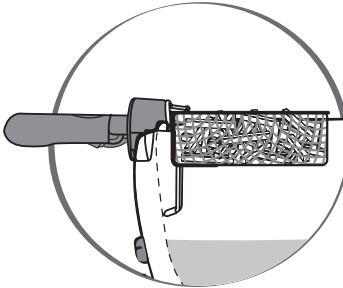
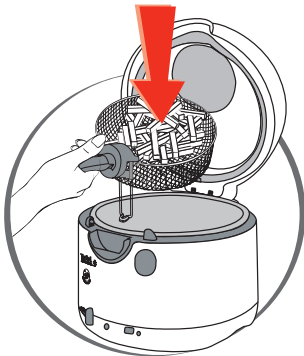
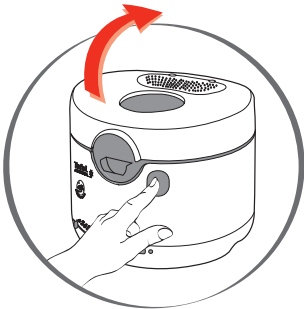
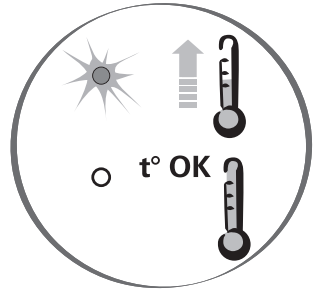
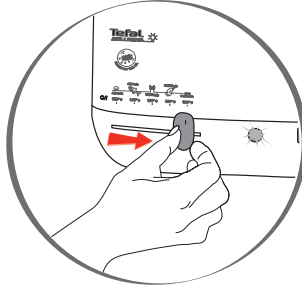
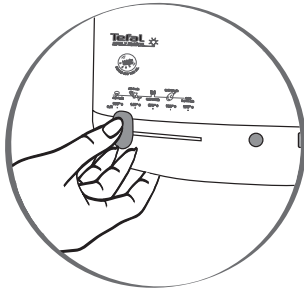

6



8

	Nb		°C	
		1000 g	190°C	+/- 12 - 16 min.
		1200 g	① 170°C ② 190°C	+/- 11 - 13 +/- 7 - 9 min.
		600 g	170°C	+/- 11 - 16 min.
		350/400 g	190°C	+/- 6 - 7 min.
	8 - 10		190°C	+/- 9 - 10 min.
	2		180°C	+/- 14 - 16 min.
	1 - 2		170°C	+/- 6 - 8 min.
	6		170°C	+/- 3 - 4 min.
		200 g	MINI	+/- 5 - 7 min.
	10 - 12		180°C	+/- 11 - 13 min.
	4		180°C	+/- 5 - 6 min.

* * *	Nb		°C	
		900 g	190°C	+/- 11 - 14 min.
		450 g	170°C	+/- 9 - 13 min.
	2	300 g	190°C	+/- 5 - 7 min.
	2		190°C	+/- 14 - 15 min.
	16	275 g	190°C	+/- 4 - 5 min.
	12	180 g	190°C	+/- 3 - 4 min.



9

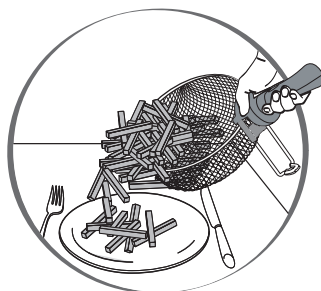
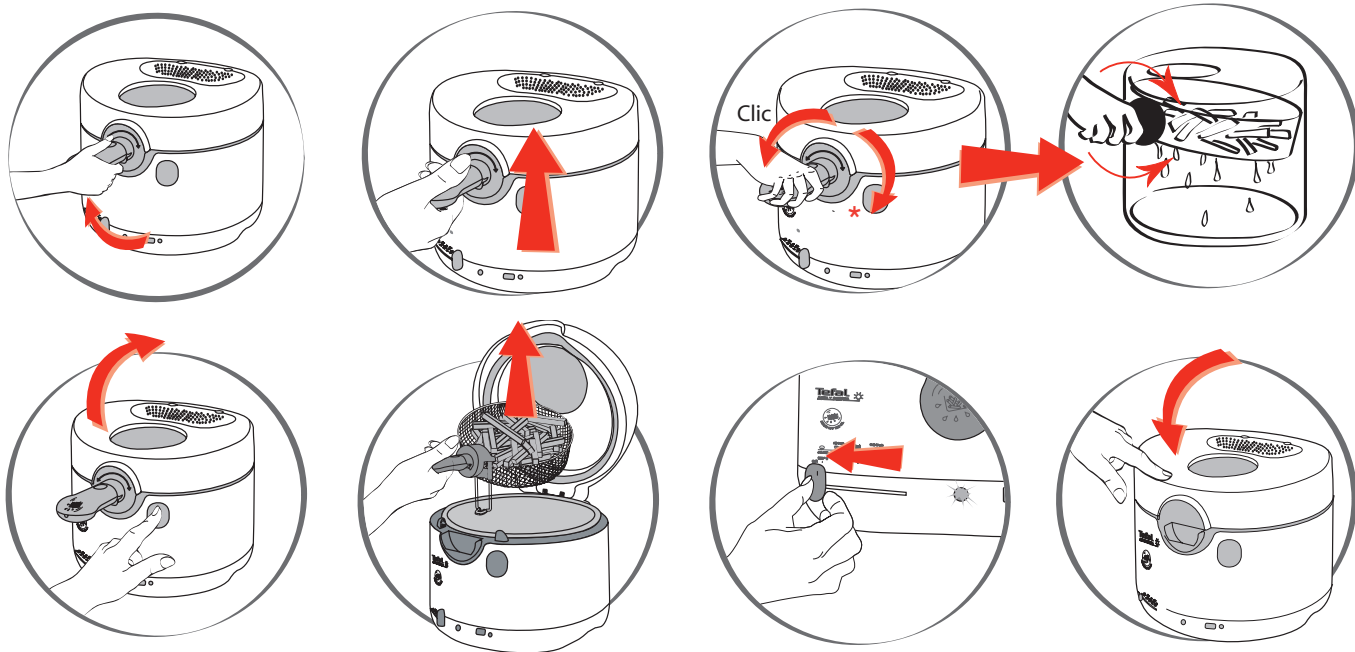

* Shake off the oil, Secouage des frites, стряхивать излишки масла, Îndepărtați uleiul OTRESTI OLJE, otresa višak ulja, ISTRESTI ULJE, protresete ulje, Изцеждане на мазнината, otresa višak ulja, ISTRESTI ULJE, protresete ulje, Изцеждане на мазнината, ليهتصماعة تيننا نطليحتا, potrząsnać koszykiem w celu usunięcia nadmiaru oleju, "злив олії", Sacudir el aceite, ryster overskydende olie af, پروغن را بچکانید, Roterende håndtak rister av overflødig fett.

10

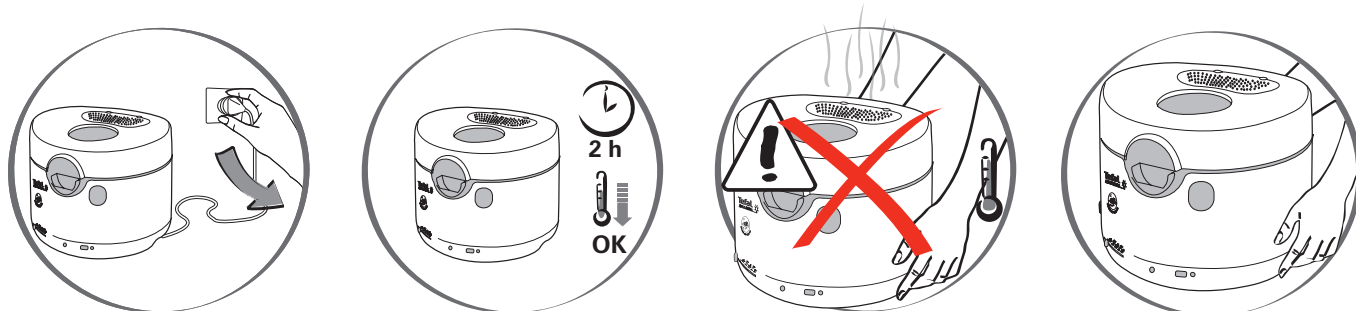

8

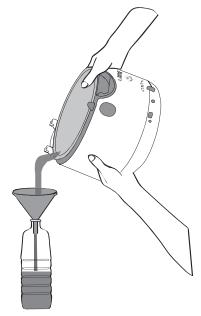

11

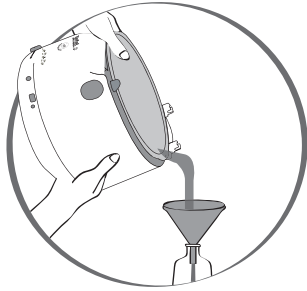

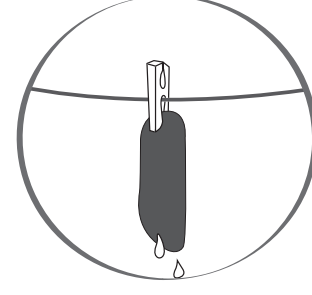
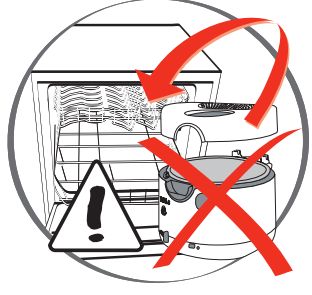
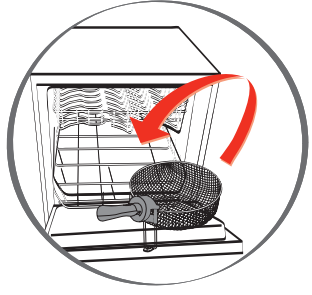
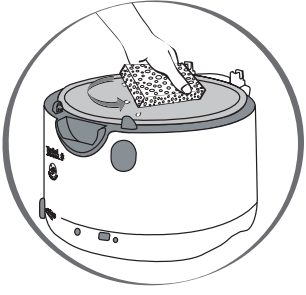
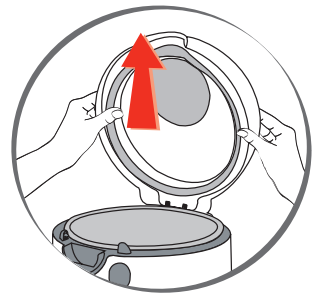

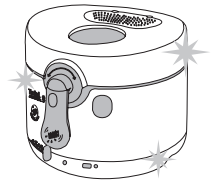

13

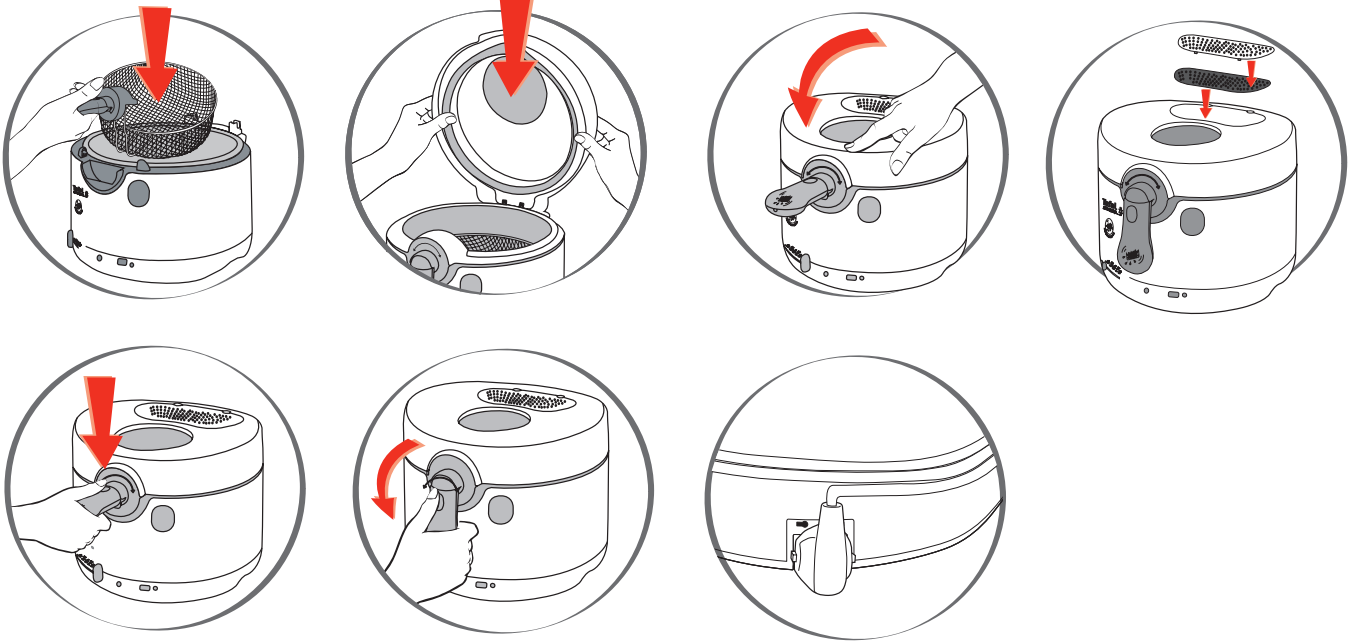

14



