







EN	User manual .....		2
FR	Mode d'emploi.....		18



 Customer service:  
# 1 888 809-9267  
Monday - Friday  
9 am to 6 pm, Eastern time  
[www.dolce-gusto.ca](http://www.dolce-gusto.ca)

 Service après-vente:  
# 1 888 809-9267  
Du lundi au vendredi,  
de 9 h à 18 h, heure de l'Est  
[www.dolce-gusto.ca](http://www.dolce-gusto.ca)



EN

## IMPORTANT SAFEGUARDS

NESCAFÉ  
Dolce  
Gusto

**When using electrical appliances, basic safety precautions shall always be followed, including the following:**

1. Read all instructions.
2. Do not touch hot surfaces.  
Use handles or knobs.
3. Connect the appliance to outlets with a grounding contact only. Electrical voltage must be 120 V.
4. To protect against fire, electric shock and injury to persons do not immerse cord, plugs or appliance in water or other liquid. Never touch cord with wet hands. Do not overfill water tank.
5. Close supervision is necessary when any appliance is used near children. Keep appliance / power cord / capsule holder out of reach of children. Children should not use the appliance.
6. Unplug from outlet when not in use.
7. Unplug from outlet before cleaning. Allow to cool before putting on or taking off parts, and before cleaning the appliance. Never clean wet or immerse appliance in any fluid. Never clean the appliance with running water. Never use detergents to clean the appliance.
8. After use of the appliance always remove the capsule and clean the capsule holder. Empty and clean drip tray and capsule bin daily.
9. Do not turn off the appliance during descaling process. Rinse the water tank and clean the appliance to avoid any residual descaling agent.
10. Any operation, cleaning and care other than normal use must be undertaken by after-sales service centers approved by NESCAFÉ Dolce Gusto Hotline.
11. In case of intensive use without allowing sufficient cooling time, the appliance will stop functioning temporarily with the red indicator light blinking. This is to protect your appliance from overheating. Switch the appliance off for 30 minutes to let it cool down.
12. Do not operate any appliance with a damaged cord or plug or after the appliance malfunctions, or has been damaged in any manner.  
Unplug cord immediately. Return appliance to the nearest authorized service facility approved by NESCAFÉ Dolce Gusto Hotline for examination, repair or adjustment.
13. Do not dismantle appliance and do not put anything into openings.
14. The use of accessory attachments not recommended by the appliance manufacturer may result in fire, electric shock or injury to persons.
15. Do not use outdoors.
16. Do not let cord hang over edge of table or counter, or touch hot surfaces or sharp edges. Do not allow cord to dangle (risk of tripping up).
17. Do not place on or near a hot gas or electric burner, or in a heated oven.
18. To disconnect, turn any control to "off", then remove plug from wall outlet. Do not unplug by pulling the cord.
19. Do not use appliance for other than intended use. Appliance is for household use only (non-commercial areas). Appliance must be used in accordance with these instructions and specifications. Use only capsules provided. Liability of manufacturer will be voided due to wrong use for not intended purposes.
20. Always close extraction head with capsule holder. Do not pull out capsule holder before indicator stops blinking.
21. Scalding may occur if the lever is opened during the brewing cycles.
22. Do not put fingers under outlet during beverage preparation.
23. Do not touch the needle of the extraction head.
24. Never carry the appliance by the extraction head.
25. **The capsule holder is equipped with one permanent magnet.** Avoid placing capsule holder near appliances and objects that can be damaged by magnetism, e.g. credit cards, diskettes and other data devices, video tapes, television and computer monitors with picture tubes, mechanical clocks, hearing aids and loud speakers.  
**Patients with pacemakers or defibrillators: Do not hold capsule holder directly over pacemaker or defibrillator.**
26. a) A short power-supply cord is to be provided to reduce risks resulting from becoming entangled in or tripping over a longer cord.  
b) Longer extension cords may be used if care is exercised in their use.  
c) If a long extension cord is used,
  - 1) The marked electrical rating of the extension cord should be at least as great as the electrical rating of the appliance.
  - 2) If the appliance is of the grounded type, the extension cord should be a grounding-type 3-wire cord, and
  - 3) The longer cord should be arranged so that it will not drape over the counter top or table top where it can be pulled on by children or tripped over.
27. **Each capsule is designed to prepare a perfect cup, and cannot be reused. The capsule should be removed from the machine after extraction.**

## SAVE THESE INSTRUCTIONS

Packaging is made of recyclable materials. Contact your local council / authority for further information on recycling programs.

Environment protection first!  
Your appliance contains valuable materials which can be recovered or recycled.



## Overview



4

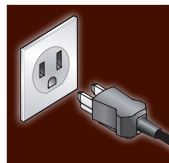

## Rinsing the machine before first use



5



## Product range



7



## Preparing a hot beverage



10



## Cleaning



12



## Descaling every 3-4 months



13



## Troubleshooting



14



**EN Overview**

**NESCAFÉ  
Dolce Gusto**

**Selection lever**

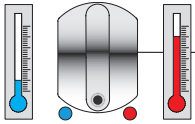

**Cold Hot**

**Locking handle**

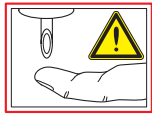

**Capsule holder**

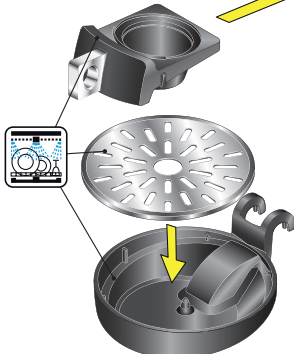

**Drip tray**

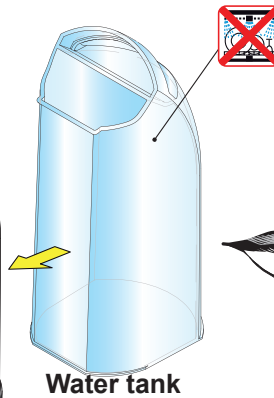

**Water tank**



**Auto shut-off**



**5 min**

**Cleaning needle**

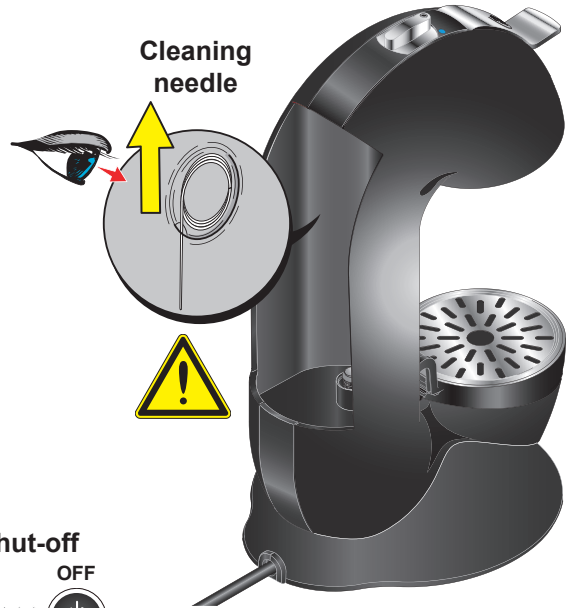

120 V, 60 Hz  
max. 1500 W

**Pumping pressure** max. 15 bar



37 oz.  
1.1 l



6.6 lbs.  
3 kg



5°C - 45°C  
41°F - 113°F



A = 11.1 in. / 28.2 cm  
B = 15.3 in. / 38.8 cm  
C = 8.3 in. / 21.0 cm

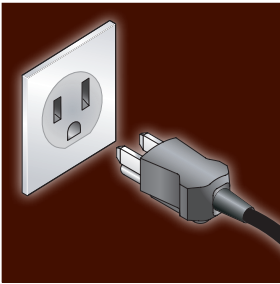

## EN Rinsing the machine before first use

NESCAFÉ  
Dolce  
Gusto

### STOP – Please read before using

Your NESCAFÉ® Dolce Gusto™ machine has an auto shut-off function which will automatically turn off the machine after 5 minutes if it is not used. This feature helps you save electricity by reducing the amount of power the machine draws while it is not in use and helps protect the life of your machine. However you can disable this function should you prefer that your machine stays on until you turn it off.



### Disable auto shut-off function

When the machine is off, press and hold the power button for 30 seconds until the machine turns off again (ignore light signals and wait until power button is no longer illuminated).

The auto shut-off function is now disabled and the machine will stay on when you next press the power button. You can turn off the machine simply by pressing the power button again.

Unplugging the machine will restore the auto shut-off function.

SHOULD YOU HAVE ANY QUESTIONS OR REQUIRE ANY ASSISTANCE, PLEASE CONTACT THE NESCAFÉ DOLCE GUSTO CUSTOMER SERVICE AT:  
1-888-809-9267 (CA)



Insert drip tray into bottom of machine.

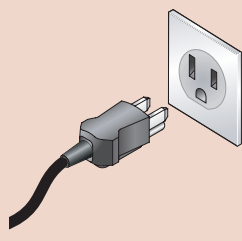
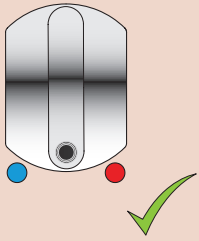
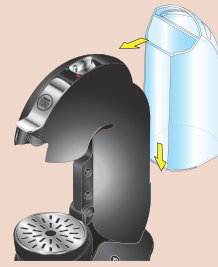
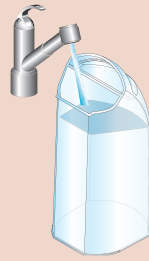

Place a large pitcher on drip tray.



Push power button, wait until light stops flashing.

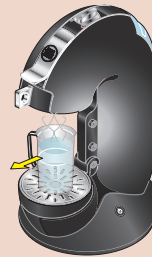
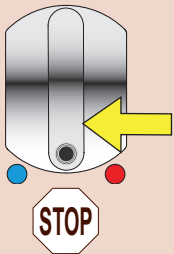
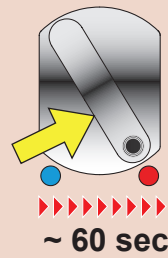
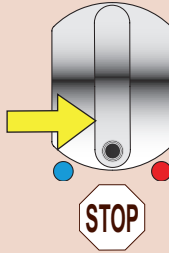
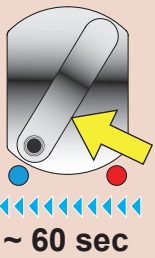
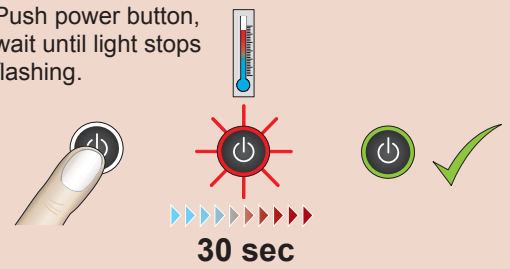

Refill the water tank and you are ready to go.

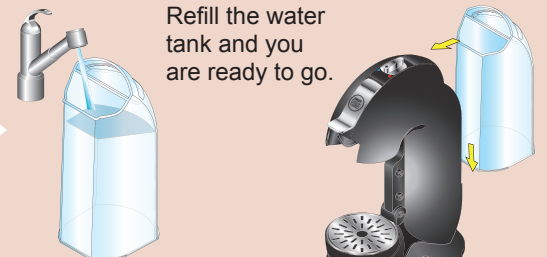



## EN Beverage variety

NESCAFÉ  
Dolce  
Gusto

### Hot Beverage

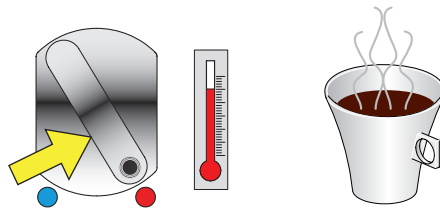

### ESPRESSO

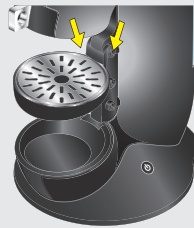

### CAFFÈ LUNGO

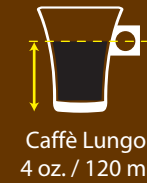
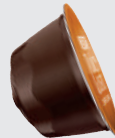
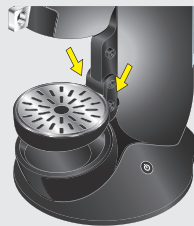

### CAFFÈ LUNGO DECAFFEINATO

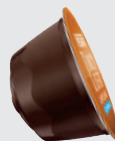
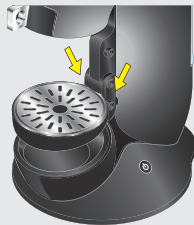

## CAFFÈ AMERICANO

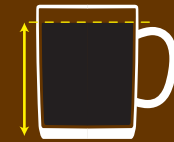
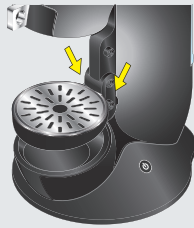

Caffè Americano  
7.8 oz. / 230 ml

## CAPPUCCINO

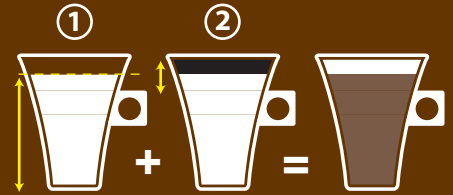
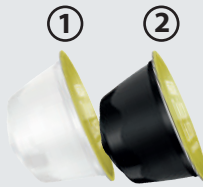
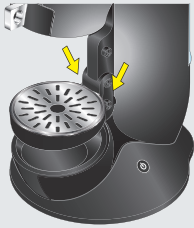

6.8 oz.  
200 ml

1.4 oz.  
40 ml

Cappuccino  
8.2 oz. / 240 ml

## CAPPUCCINO SKINNY

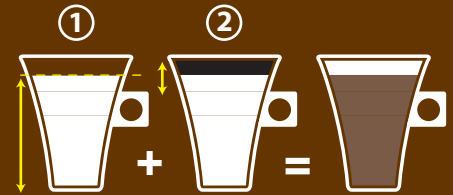
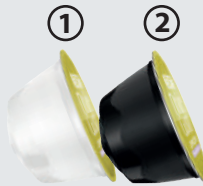
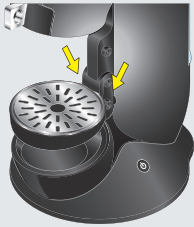

6.8 oz.  
200 ml

1.4 oz.  
40 ml

Cappuccino Skinny  
8.2 oz. / 240 ml

## MOCHA

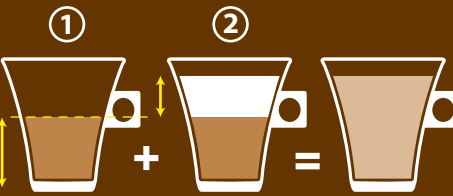
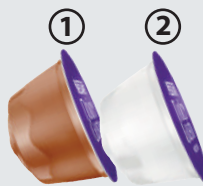

3.7 oz.  
110 ml

3.7 oz.  
110 ml

Mocha  
7.2 oz. / 220 ml

## CHOCOCINO

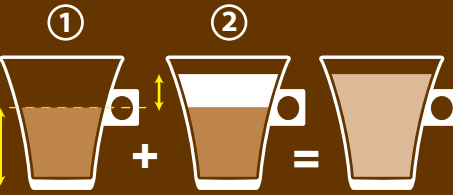

3.4 oz.  
100 ml

3.7 oz.  
110 ml

Chococino®  
7.1 oz. / 210 ml



## LATTE MACCHIATO

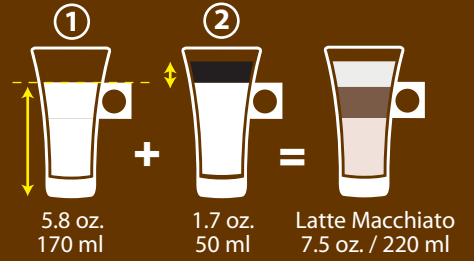
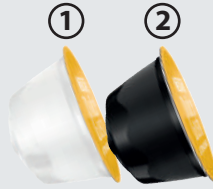
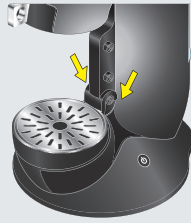

## Cold Beverage

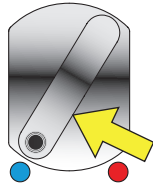
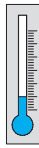

## CAPPUCCINO ICE

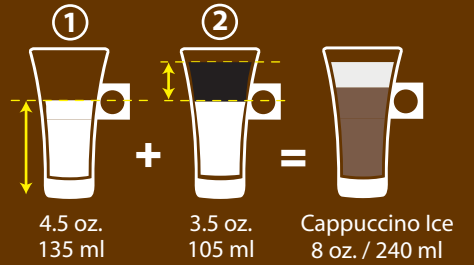
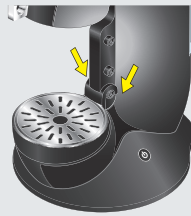

## NESTEA PEACH

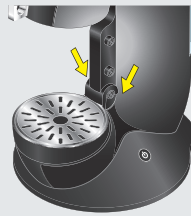

Nestea Peach  
6.8 oz. / 200 ml



## EN Preparing a hot beverage

NESCAFÉ  
Dolce  
Gusto

Push power button,  
wait until light stops  
flashing.

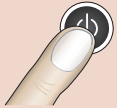

30 sec

Adjust the drip tray  
to the height of your  
beverage.

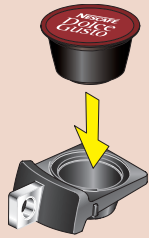
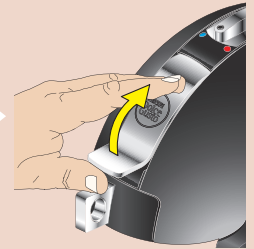
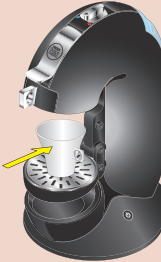
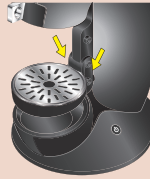

Slide in capsule holder  
while locking handle  
is up.

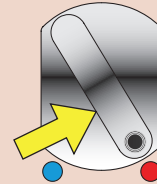
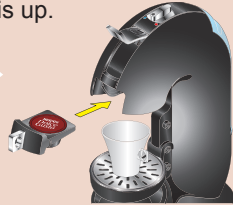

Turn lever back to neu-  
tral when your beverage  
is to your liking.

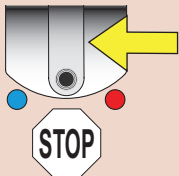

Wait until light  
stops flashing.



5 sec

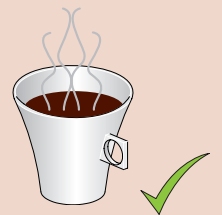
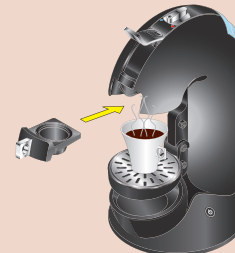
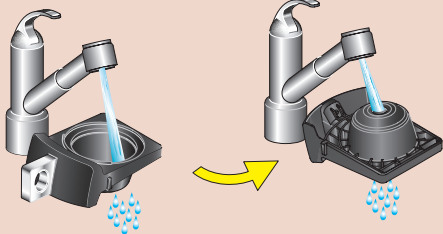
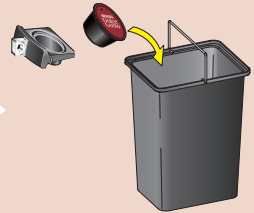
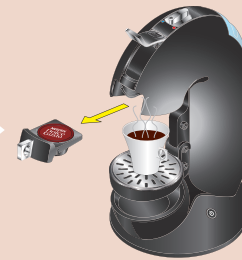
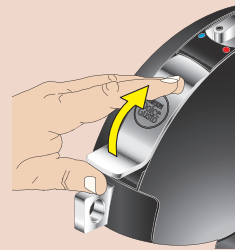



**EN Economy mode**

**NESCAFÉ  
Dolce  
Gusto**

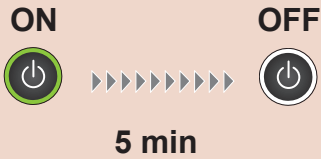



**EN Cleaning**

**NESCAFÉ  
Dolce  
Gusto**

**Daily cleaning**



Drip tray

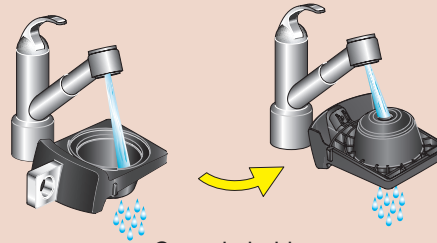

Capsule holder



Water tank

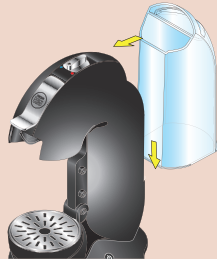
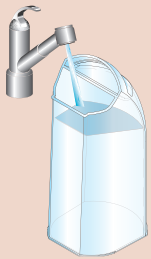

**Whenever the machine head is dirty / Weekly cleaning**

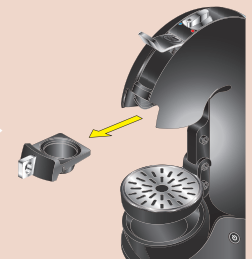
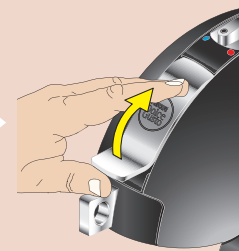

Insert capsule holder without a capsule inside.

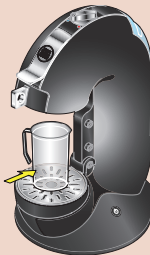

Push power button, wait until light stops flashing.

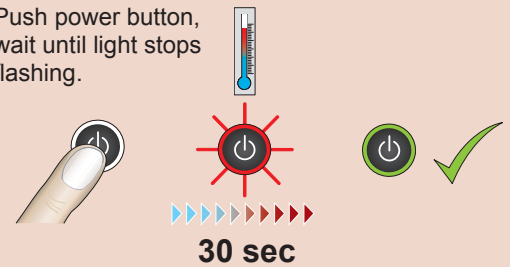

**30 sec**

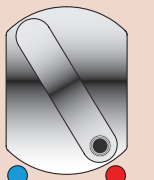

~ 10 sec

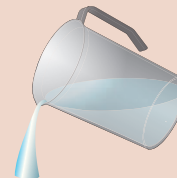
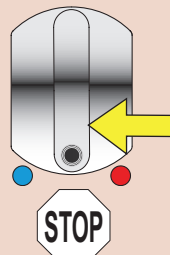



## EN Descaling every 3-4 months

NESCAFÉ  
Dolce  
Gusto

### Background information

There are minerals such as calcium and magnesium naturally present in most water supplies. High count of solids is referred to as hard water.

Scale is the sediment boiled out of the water that eventually coats the internal brewing components of any coffee or espresso machine.

Descaling is critical to the long life of the product. In areas with known high mineral content it's important to descale about once per month. Otherwise every 3-4 months is adequate.



Read instruction on the descaling packet.



Do not put powder directly on the machine.



Do not use vinegar.



Do not interrupt cycle.

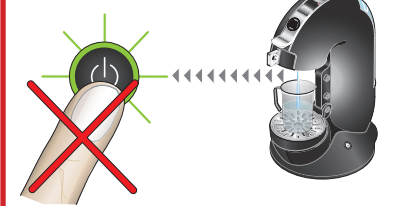

If dispensing is slower than usual, or if beverage is cooler than usual, descale.

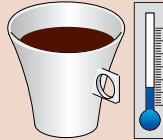

Order descaling packet over the phone or the internet.

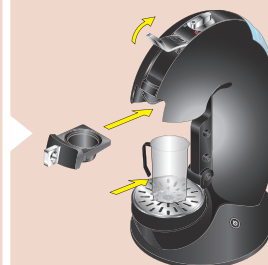
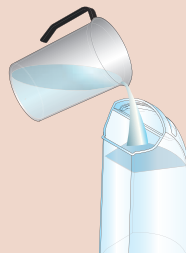
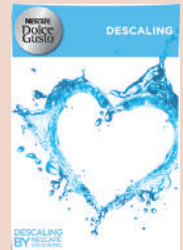
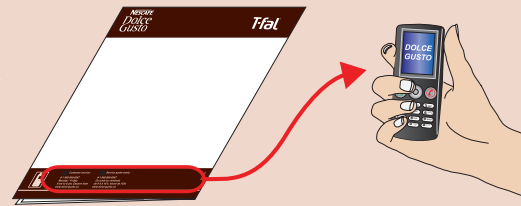

Press power button for 5 seconds to enter descaling mode.

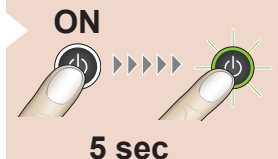

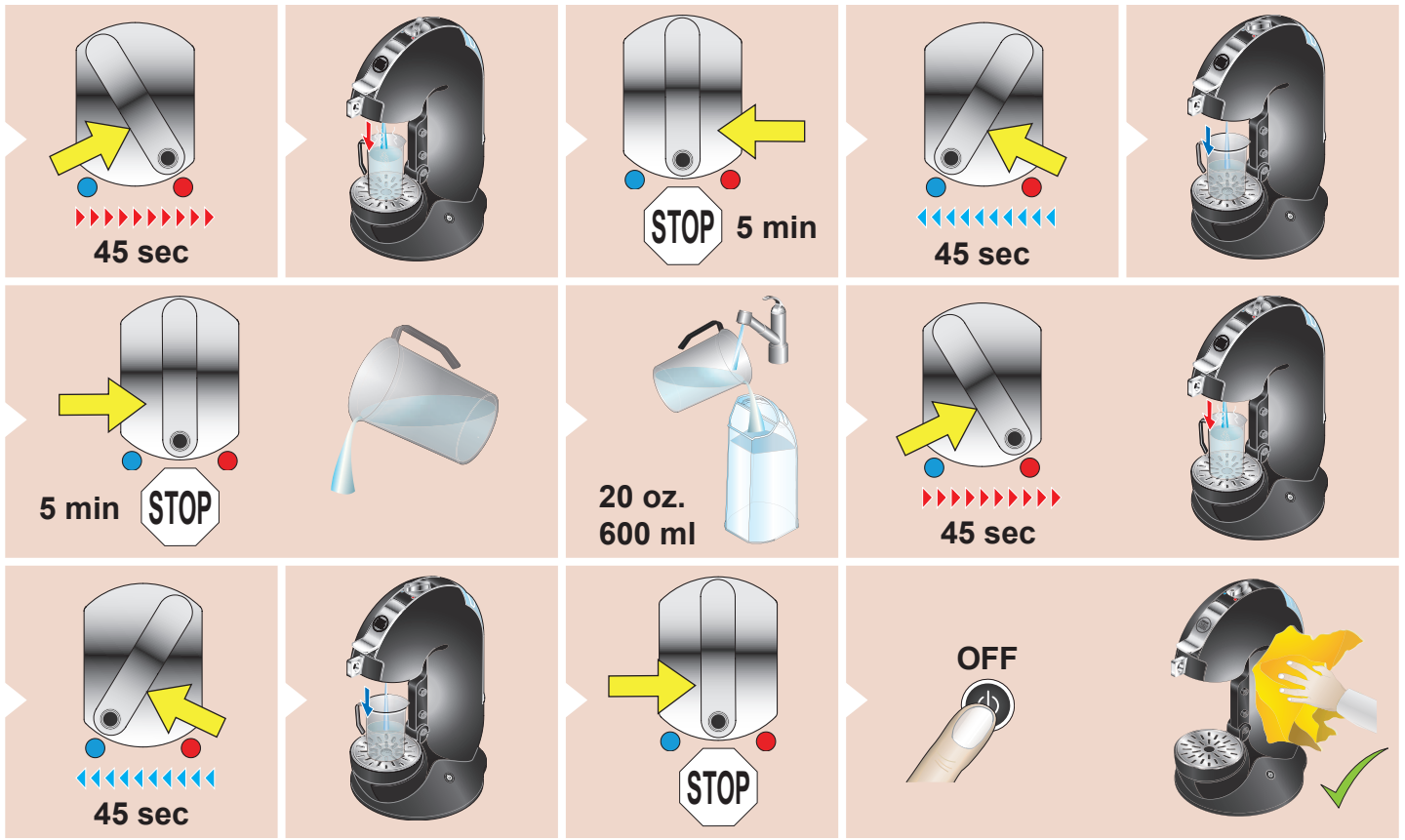

## EN Troubleshooting

NESCAFÉ  
Dolce  
Gusto

If power button does not light up:

- check connection of power cord
- check if main voltage is available.

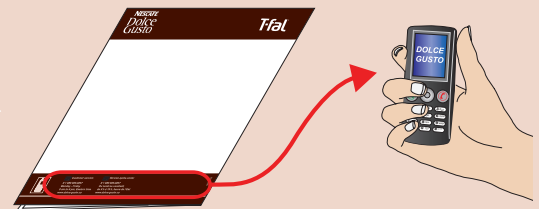
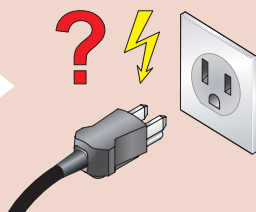

If beverage leaks from the capsule holder, check if the capsule has not been pierced twice.

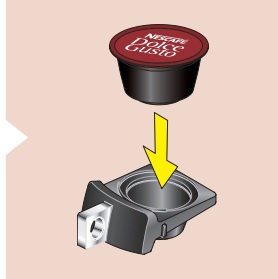
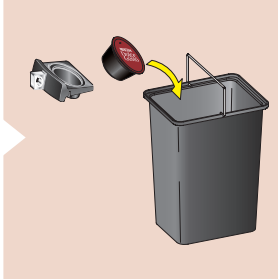
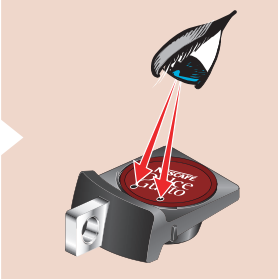

If upon starting the machine you see no flow or the flow suddenly stops, the water may be building up inside the capsule. Stop the machine by turning the selection lever to the neutral position. After 20 minutes lift the locking handle and discard the capsule.

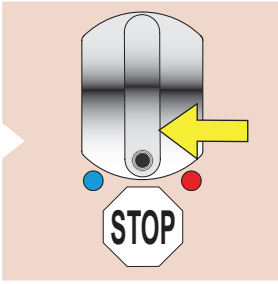
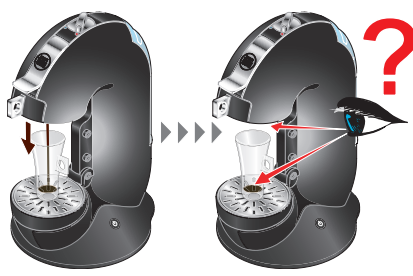

If no liquid comes out when rinsing or descaling: Unblock injector with cleaning needle.

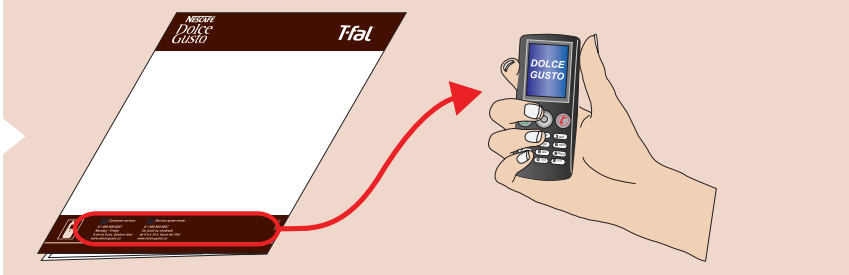
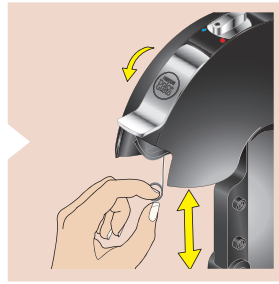
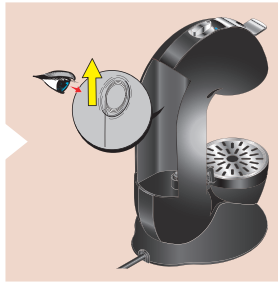



If power button flashes, unplug for 30 minutes.  
Plug machine back in.  
Turn on the machine.  
If power button still flashes, call customer service.

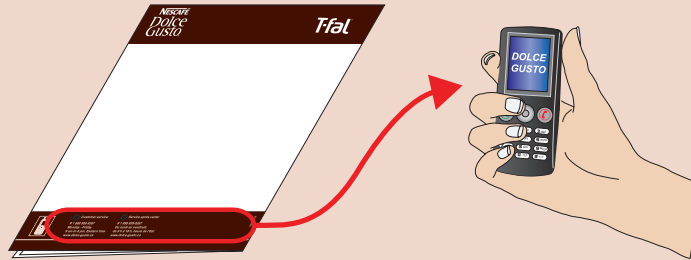
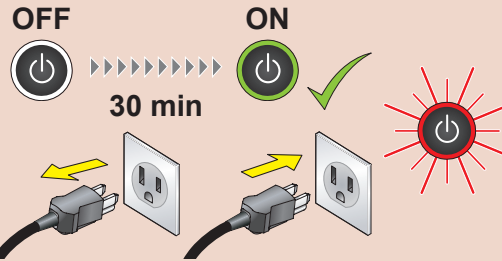

If dispensing is slower than usual, check if the tank is filled and inserted correctly.

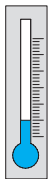
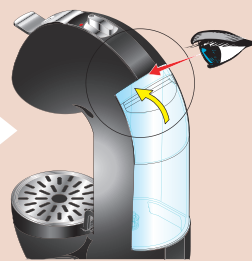
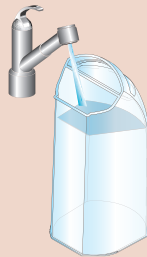

If beverage is cooler than usual, descale.







## LIMITED WARRANTY

NESCAFÉ  
Dolce  
Gusto

This Nescafé Dolce Gusto product is warranted for 2 years from the date of purchase against defects in material and workmanship. During this period, the Nescafé Dolce Gusto product that, upon inspection by Nescafé Dolce Gusto, is proved defective, will be repaired or replaced, at Nescafé Dolce Gusto option, without charge to the customer. If a replacement product is sent, it will carry the remaining warranty of the original product. This warranty does not apply to any defect arising from a buyer's or user's misuse of the product, negligence, failure to follow Nescafé Dolce Gusto instructions, use on current or voltage other than that stamped on the product, wear and tear, alteration or repair not authorized by Nescafé Dolce Gusto, or use for commercial purposes, or appliances not descaled as specified.

THE WARRANTIES SET FORTH HEREIN ARE EXCLUSIVE AND NO OTHER WARRANTIES, EXPRESS OR IMPLIED, INCLUDING BUT NOT LIMITED TO ANY WARRANTY OF MERCHANTABILITY OR FITNESS FOR A PARTICULAR PURPOSE OR USE, ARE MADE BY NESCAFÉ DOLCE GUSTO OR ARE AUTHORIZED TO BE MADE WITH RESPECT TO THE PRODUCT.

Some states do not allow limitation on how long an implied warranty lasts or do not allow the exclusion of incidental or consequential damages, so the above limitations may not apply to you. This warranty gives you specific legal rights, and you may also have other rights, which vary from state to state.

If you believe your product is defective, take the product (or send it postage prepaid) along with proof of purchase to the nearest authorized Nescafé Dolce Gusto Service Center. (To find the nearest authorized Nescafé Dolce Gusto Service Center visit the Nescafé Dolce Gusto website or contact the Nescafé Dolce Gusto Consumer Service in your country indicated below). If you send the product, please include a letter explaining the nature of the claimed defect.

Nescafé Dolce Gusto Service Centre locations can be found by visiting the website [www.dolce-gusto.ca](http://www.dolce-gusto.ca) in Canada.

When shipping the product to the service center please include a note explaining the issue, a copy of the sales receipt and provide a valid return address on the outside of the shipping box (no PO Boxes). If the product is out of warranty or warranty can't be validated, the service center will send an estimate of repair for your approval.

### CONSUMER SERVICE

If you have additional questions, please call our Consumer Service Department. It is helpful to have the product available at the time of your call and to know the reference number that can generally be found on the base of the product.

### CANADA

Phone 1-888-809-9267  
Hours Monday – Friday  
from 9:00 a.m. – 6:00 p.m. (EST)

Letters should be addressed to  
Nescafé Dolce Gusto  
Consumer Care Centre / Centre d'aide  
aux consommateurs  
PO Box 186  
Cobourg ON K9A 4K5  
Canada



FR

## CONSIGNES DE SÉCURITÉ

NESCAFÉ  
Dolce  
Gusto

### Lors de l'utilisation d'appareils électriques, respecter toutes les précautions de base, y compris les suivantes :

1. Lire toutes les instructions.
2. Ne pas toucher les surfaces très chaudes. Utiliser les poignées ou boutons.
3. Connecter seulement l'appareil à des prises à terre. La tension électrique doit être égale à 120 V.
4. Pour éviter des risques d'incendie, d'électrocution et de blessures, ne pas tremper le cordon d'alimentation ou les fiches électriques dans l'eau ou un autre liquide. Ne jamais toucher le cordon avec des mains humides. Ne pas trop remplir le réservoir d'eau.
5. Surveiller étroitement l'appareil si on l'utilise à proximité d'enfants. Conserver l'appareil/le cordon d'alimentation/le porte-capsule hors de portée des enfants. Les enfants n'ont pas le droit d'utiliser l'appareil.
6. Débrancher l'appareil en cas de non-emploi.
7. Débrancher l'appareil avant un nettoyage. Laisser refroidir l'appareil avant de monter ou de démonter des pièces et avant de le nettoyer. Ne jamais nettoyer l'appareil en présence d'humidité ou en le plongeant dans un fluide. Ne jamais nettoyer l'appareil sous l'eau du robinet. Ne jamais utiliser des détergents pour le nettoyage de l'appareil.
8. Toujours enlever la capsule et nettoyer le porte-capsule après l'usage de l'appareil. Vider et nettoyer le bac d'égouttage et le bac à capsules usagées tous les jours.
9. Ne pas mettre l'appareil hors tension pendant le détartrage. Rincer le réservoir d'eau et nettoyer l'appareil pour éviter tout reste de détartrant.
10. Toute opération, tous travaux de nettoyage ou d'entretien qui dépassent le cadre normal sont réservés aux centres de service après-vente agréés par NESCAFÉ Dolce Gusto Hotline.
11. En cas d'usage intensif sans intervalle de temps suffisant pour le refroidissement, l'appareil cessera provisoirement de fonctionner et le témoin lumineux rouge clignotera. Ce dispositif protège votre appareil contre la surchauffe. Arrêter l'appareil pendant 30 minutes afin de le laisser refroidir.
12. Ne pas faire marcher l'appareil avec un cordon d'alimentation ou une fiche endommagée ou après un dysfonctionnement de l'appareil ou tout autre dommage. Débrancher immédiatement le cordon d'alimentation. Renvoyer l'appareil au centre de service après-vente agréé par NESCAFÉ Dolce Gusto Hotline le plus proche pour inspection, réparation ou ajustement.
13. Ne pas désassembler l'appareil et ne rien mettre dans les ouvertures.
14. L'utilisation d'accessoires non recommandés par le fabricant de l'appareil peut provoquer un incendie, des électrocutions ou des blessures.
15. L'appareil n'est pas conçu pour un usage à l'extérieur.
16. Ne pas laisser pendre le cordon d'alimentation sur le bord d'une table ou d'un comptoir et éviter qu'il entre en contact avec des surfaces chaudes ou des arêtes vives. Ne pas non plus laisser pendre le cordon d'alimentation d'une autre manière (risque de trébuchement).
17. Ne pas placer l'appareil à côté d'un brûleur à gaz ou électrique chaud et ne pas le mettre dans un four chauffé.
18. Pour débrancher l'appareil, le mettre hors tension avec le bouton marche/arrêt puis déconnecter la fiche électrique de la prise de courant. Ne pas débrancher la fiche en tirant sur le cordon d'alimentation.
19. Ne pas utiliser l'appareil pour des applications non prévues. L'appareil se destine exclusivement à un usage domestique (non commercial). Utiliser l'appareil conformément aux présentes instructions et spécifications. Employer seulement les capsules fournies. Le fabricant décline toute responsabilité en cas d'utilisation incorrecte ou non conforme à la destination.
20. Toujours fermer la tête d'extraction avec le porte-capsule. Ne pas extraire le porte-capsule avant la fin du clignotement du témoin.
21. Risque de brûlures en cas d'ouverture du levier pendant la préparation de boissons.
22. Ne pas mettre les doigts sous la sortie du liquide pendant la préparation de boissons.
23. Ne pas toucher l'aiguille de la tête d'extraction.

24. Ne jamais porter l'appareil au niveau de la tête d'extraction.

**25. Le porte-capsule est pourvu d'un aimant permanent.**

Eviter de placer le porte-capsule à côté d'appareils ou d'objets qu'une magnétisation peut endommager, par exemple cartes de crédit, disquettes et autres supports de stockage de données, cassettes vidéo, écrans de téléviseur et d'ordinateur à tubes cathodiques, montres mécaniques, prothèses auditives et haut-parleurs.

**Remarque destinée aux porteurs de stimulateurs cardiaques et de défibrillateurs : ne pas tenir directement le porte-capsule au-dessus du stimulateur cardiaque ou du défibrillateur.**

26. a) Fournir un cordon d'alimentation court pour réduire les risques de trébuchement et d'enchevêtrement.
- b) Il est possible d'utiliser une rallonge plus longue en prenant les précautions nécessaires.
- c) En cas d'utilisation d'une rallonge:
- 1) Les charges électriques de la rallonge doivent être au moins égales à celles de l'appareil.
  - 2) Si l'appareil est mis à la terre, la rallonge doit être un câble de type terre à 3 fils et
  - 3) le cordon plus long doit être posé de telle façon qu'il ne pende pas sur le bord d'un comptoir ou d'une table où il pourrait être tiré par des enfants ou faire trébucher des personnes.

**27. Chaque capsule est conçue pour préparer une tasse d'un délicieux café et ne peut être réutilisée. La capsule doit être retirée de la machine après extraction.**

## **GARDER CES INSTRUCTIONS**

L'emballage est fait de matériaux recyclables. Contactez le conseil local / l'autorité compétente pour plus d'informations sur les programmes de recyclage.

Priorité à la protection de l'environnement!  
Votre appareil contient des matériaux de haute valeur qui peuvent être récupérés ou recyclés.



## Vue d'ensemble de la machine



38

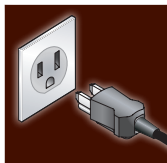

## Rinçage de la machine avant la première mise en service



39



## Variété de boisson



41



## Préparation d'une boisson chaude



44



## Nettoyage



46

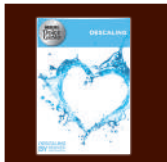

## Détartrage tous les 3-4 mois



47



## Dépannage



48



**FR** Vue d'ensemble de la machine

**NESCAFÉ**  
**Dolce**  
**Gusto**

Levier sélecteur

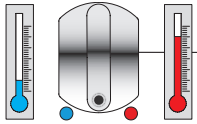

Froid Chaud

Poignée de verrouillage

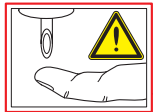

Porte-capsule

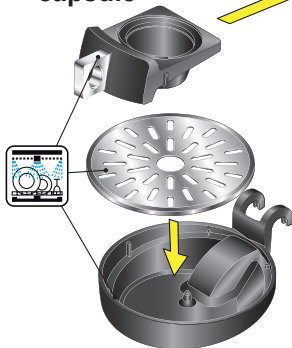

Grille d'égouttage

Réservoir d'eau

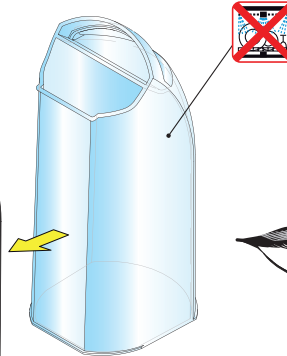

Aiguille de nettoyage

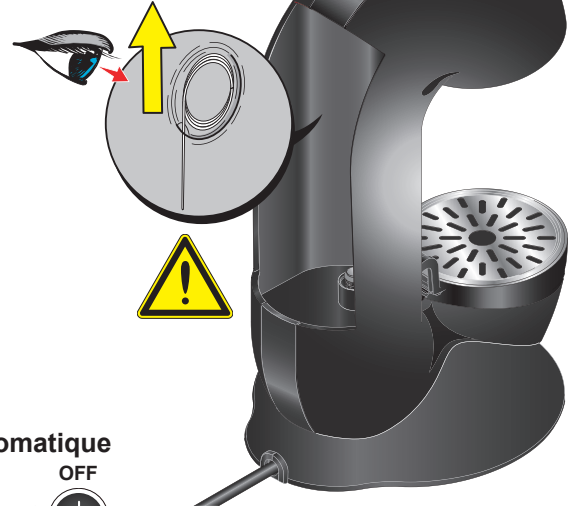

OFF

ON

Arrêt automatique

ON

OFF

5 min



120 V, 60 Hz  
max. 1500 W

Pression de pompe  
max. 15 bar



37 oz.  
1.1 l



6.6 lbs.  
3 kg



5°C - 45°C  
41°F - 113°F



A = 11.1 in. / 28.2 cm  
B = 15.3 in. / 38.8 cm  
C = 8.3 in. / 21.0 cm

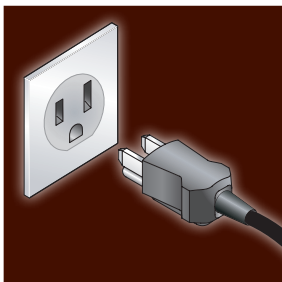

## **FR** Rinçage de la machine avant la première mise en service

**NESCAFÉ**  
**Dolce**  
**Gusto**

### **STOP – Lire ces indications avant l'emploi**

Cette machine à café NESCAFÉ® Dolce Gusto™ machine dispose d'une fonction d'arrêt automatique qui la met hors tension après une période d'inactivité de 5 minutes. Cette option permet d'économiser de l'énergie en réduisant la consommation électrique pendant l'intervalle de repos. Elle optimise aussi la durée de vie de la machine.

On peut cependant désactiver cette fonction si l'on préfère que la machine reste allumée jusqu'à sa mise hors tension manuelle.



### **Désactivation de la fonction d'arrêt automatique**

Quand la machine est hors tension, appuyer sur le bouton marche/arrêt pendant environ 30 secondes, jusqu'à ce qu'elle s'allume (ignorer les signaux lumineux et attendre l'extinction de l'éclairage du bouton marche/arrêt).

L'arrêt automatique est alors désactivé, et la machine restera sous tension jusqu'à la prochaine pression du bouton marche / arrêt. Pour éteindre la machine, il suffit de réappuyer sur ce bouton.

Après un débranchement de la machine, la fonction arrêt automatique redevient active.

**POUR TOUTE QUESTION OU AIDE, VEUILLEZ APPELER LE SERVICE CLIENTS NESCAFÉ DOLCE GUSTO AU: 1-888-809-9267 (CA)**



Insérez la grille d'égouttage dans la partie inférieure de la machine.

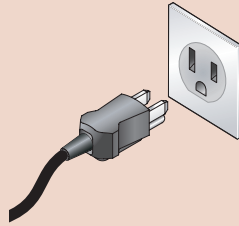
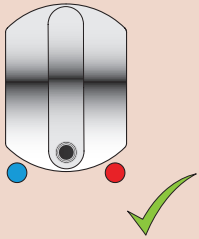
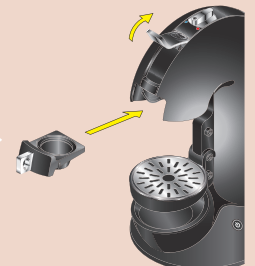
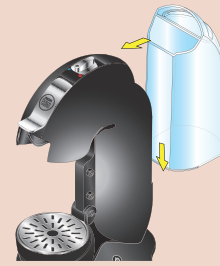
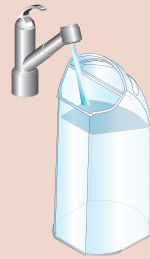

Posez un grand récipient sur la grille d'égouttage.



Presser le bouton marche/arrêt. Attendre la fin du clignotement de la lumière.



30 sec

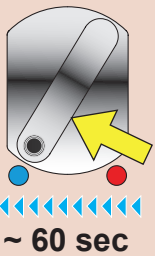

~ 60 sec

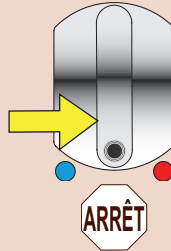

ARRÊT

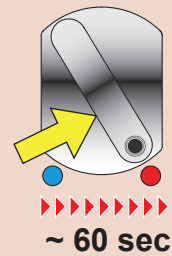

~ 60 sec

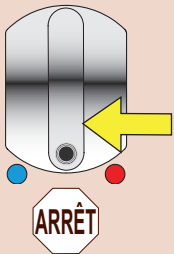

ARRÊT

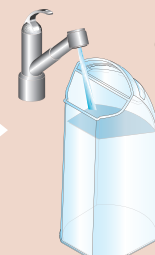
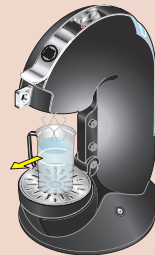

Remplissez le réservoir d'eau. La machine est prête à l'emploi.





**FR** Variété de boisson

NESCAFÉ  
Dolce  
Gusto

**Boisson chaude**

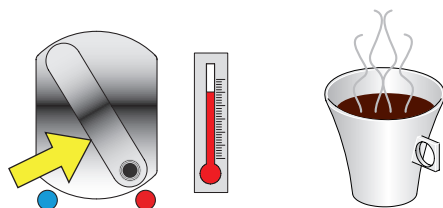

**ESPRESSO**

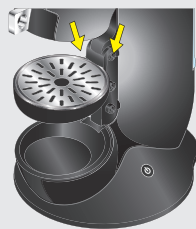

**CAFFÈ LUNGO**

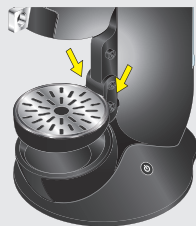

**CAFFÈ LUNGO DECAFFEINATO**

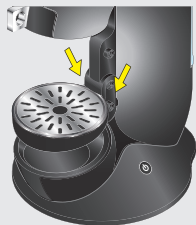



## CAFFÈ AMERICANO

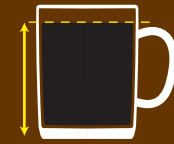
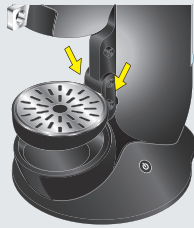

Caffè Americano  
7.8 oz. / 230 ml

## CAPPUCCINO

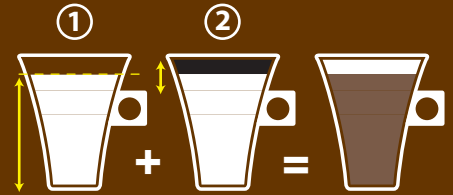
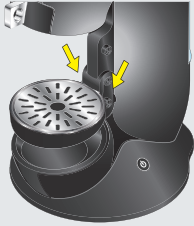

6.8 oz.  
200 ml

1.4 oz.  
40 ml

Cappuccino  
8.2 oz. / 240 ml

## CAPPUCCINO SKINNY

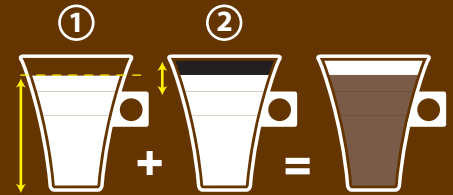
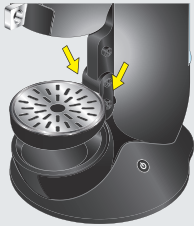

6.8 oz.  
200 ml

1.4 oz.  
40 ml

Cappuccino Skinny  
8.2 oz. / 240 ml

## MOCHA

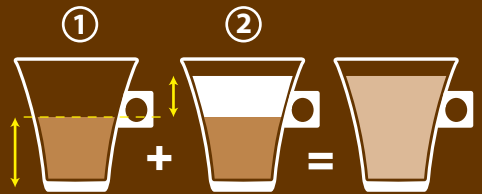

3.7 oz.  
110 ml

3.7 oz.  
110 ml

Mocha  
7.2 oz. / 220 ml

## CHOCOCINO

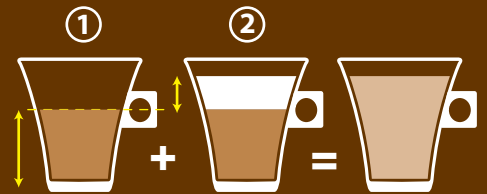

3.4 oz.  
100 ml

3.7 oz.  
110 ml

Chococino®  
7.1 oz. / 210 ml

## LATTE MACCHIATO

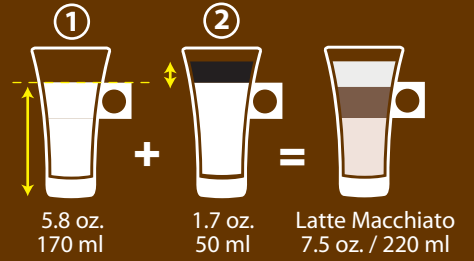
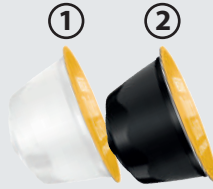
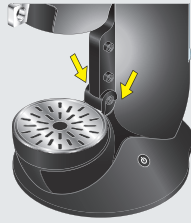

## Boisson froide

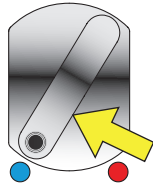
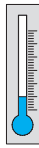

## CAPPUCCINO ICE

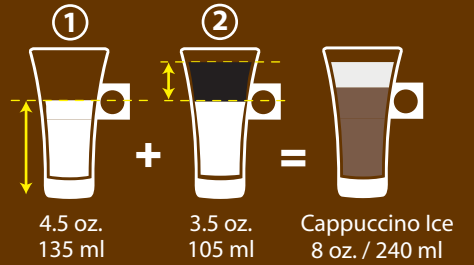
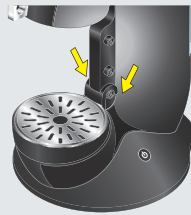

## NESTEA PÊCHE

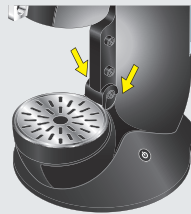

Nestea Pêche  
6.8 oz. / 200 ml



## FR Préparation d'une boisson chaude

NESCAFÉ  
Dolce  
Gusto

Presser le bouton marche/arrêt. Attendre la fin du clignotement de la lumière.

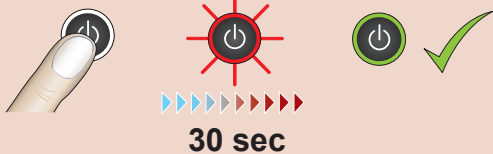

Adaptez la grille d'égouttage à la hauteur du récipient.

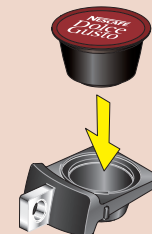
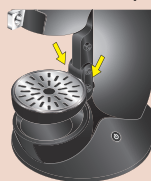

Insérez le porte-capsule pendant que la poignée de verrouillage se trouve en haut.

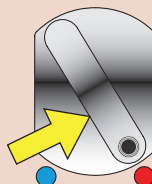
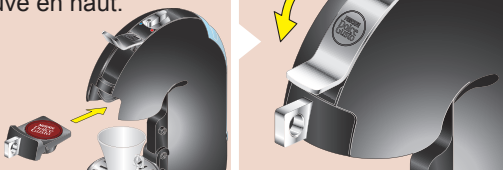

Remettez le levier au milieu après avoir rempli le récipient comme vous le souhaitez.

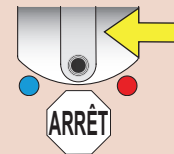

Attendre la fin du clignotement de la lumière.

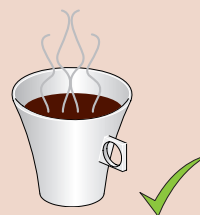
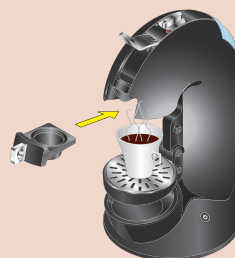
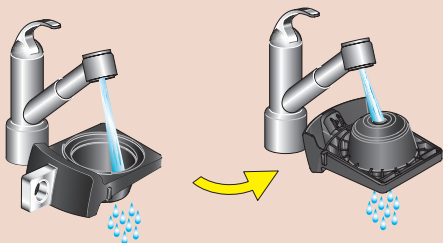
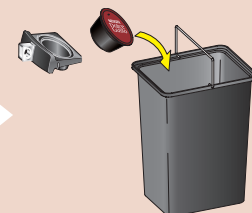
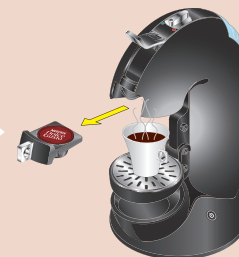
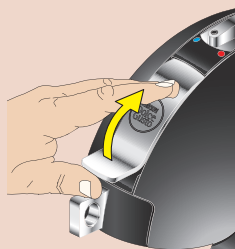

Ne pas remplir le réservoir d'eau chaude.

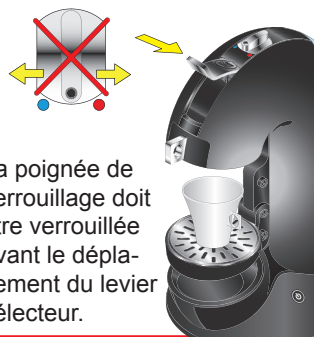
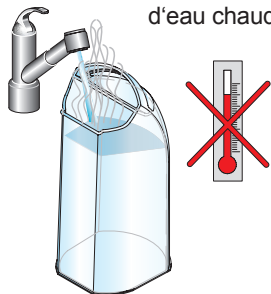

La poignée de verrouillage doit être verrouillée avant le déplacement du levier sélecteur.

Ne pas débloquer la poignée de verrouillage pendant la préparation de café.



Attendre cinq secondes à la fin du clignotement du bouton marche/arrêt.

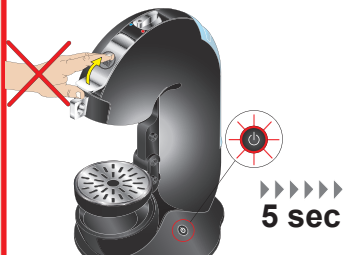

5 sec



Attention!  
Ne pas toucher les capsules lors du retrait de la machine.



**FR** Mode Eco

**NESCAFÉ**  
Dolce  
Gusto



ON



OFF



5 min



**FR** Nettoyage

**NESCAFÉ**  
**Dolce**  
**Gusto**

**Nettoyage**  
**quotidien**

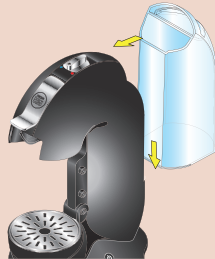
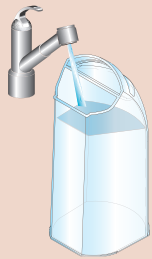
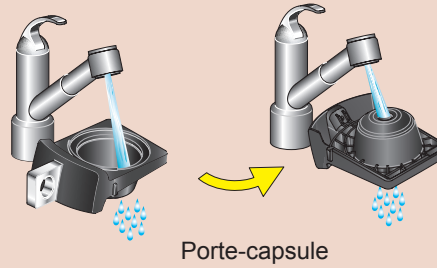

**Chaque fois**  
**que la tête de**  
**la machine est**  
**sale / Nettoyage**  
**hebdomadaire**

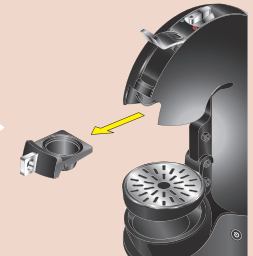
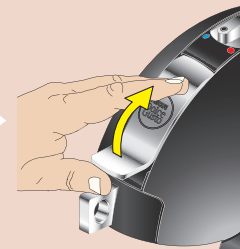

Insérez le porte-capsule vide.

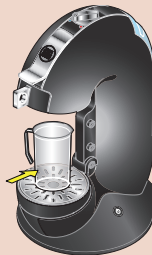

Presser le bouton marche/arrêt. Attendez la fin du clignotement de la lumière.

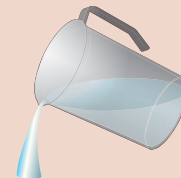
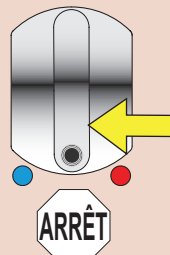
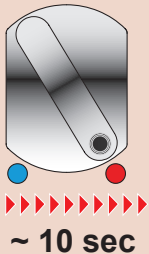



## FR D tartrage tous les 3-4 mois

NESCAF   
Dolce  
Gusto

### Informations g n rales

L'eau contient en g n ral des min raux comme le calcium et le magn sium. Quand la teneur en mati res solides est importante, on parle d'eau dure. Les s diments r sultant de l' bullition de l'eau sont du tartre. Ce dernier peut se d poser sur les  l ments internes d'une machine   caf  ou   expresso.

Il est important de d tartrer la machine pour maximiser sa dur e de vie. Dans les r gions o  l'eau a une teneur min rale  lev e, il est vivement recommand  de proc der au d tartrage environ une fois par mois. Dans les autres cas, tous les 3-4 mois.



Lisez les instructions figurant sur le paquet de d tartrage.



Ne mettez pas la poudre directement sur la machine.

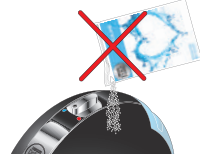

Ne pas utiliser de vinaigre.

N'interrompez pas le cycle.

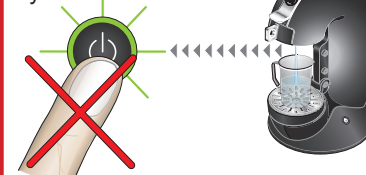

Si la distribution est plus lente ou la boisson plus froide que d'habitude, effectuer un d tartrage.



Commandez le paquet de d tartrage par t l phone ou Internet.

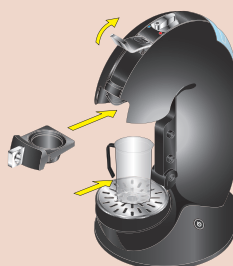
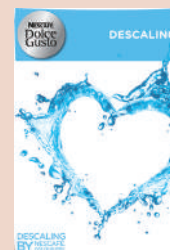
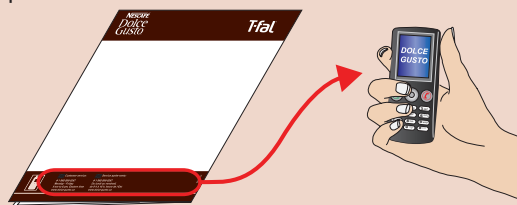

Appuyer sur le bouton marche/arr t pendant 5 secondes pour activer le mode d tartrage.

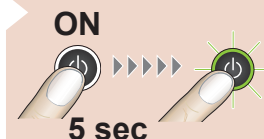

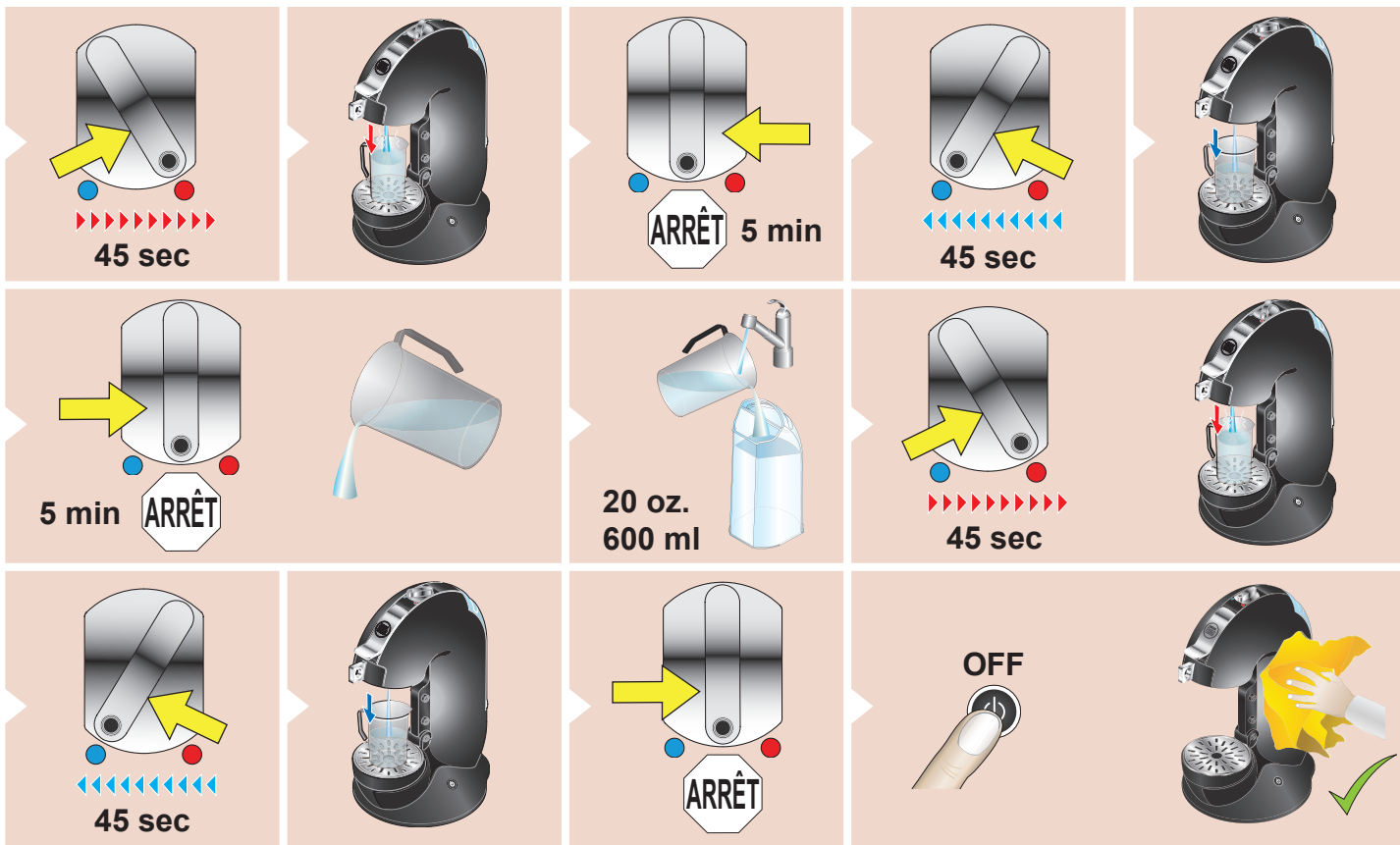

**FR** Dépannage

**NESCAFÉ**  
**Dolce**  
**Gusto**

Si le bouton marche/  
arrêt n'est pas allumé:

- vérifiez la connexion du  
cordon d'alimentation
- vérifiez si la machine  
est sous tension.

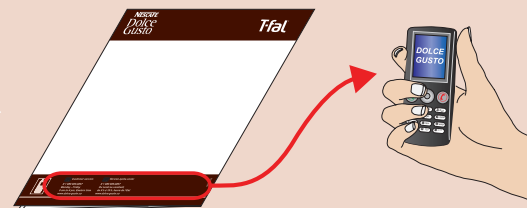
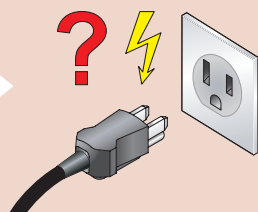

Si la distribution est plus lente ou la boisson plus froide que d'habitude, effectuer un détartrage.

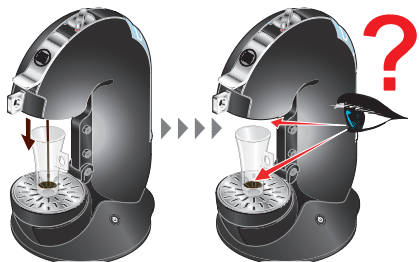
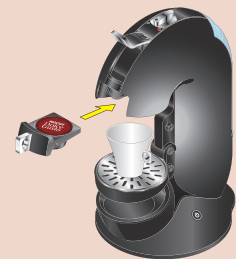
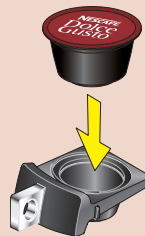
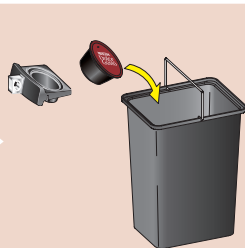
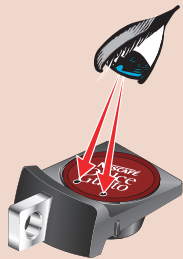

En cas d'absence d'écoulement ou d'arrêt soudain du flux après la mise sous tension de la machine, il se peut que la capsule se remplisse d'eau.  
Arrêter la machine en réglant le levier de sélection en position neutre.  
Lever la poignée au bout de 20 minutes et jeter la capsule.

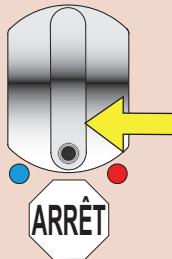

Haute pression

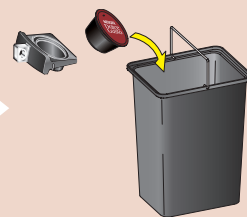
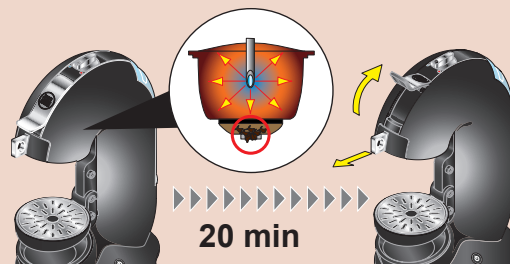

S'il n'y a pas de sortie de liquide au moment du rinçage ou du détartrage: débloquer l'injecteur avec une aiguille de nettoyage.

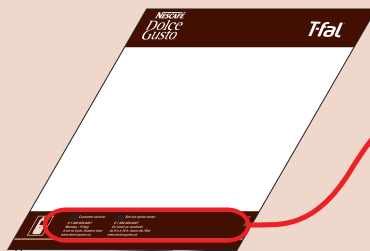
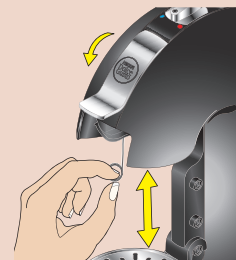
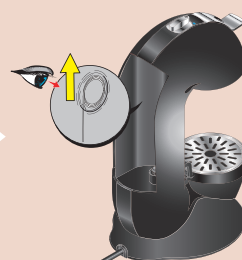
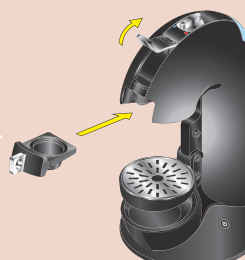





Si le bouton marche/arrêt clignote, débrancher la machine pendant 30 minutes.  
Rebrancher la machine.  
La remettre sous tension.  
Si le bouton marche/arrêt continue à clignoter, appeler le service après-vente.

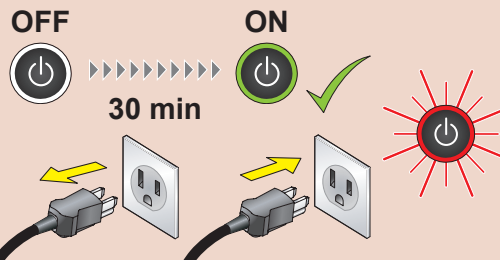

Si le débit est plus faible que d'habitude, vérifier le niveau du réservoir et si ce dernier est inséré correctement.

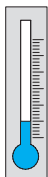
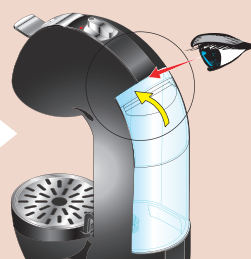
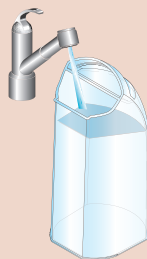

Si la boisson est plus froide que d'habitude, effectuer un détartrage.





FR

## GARANTIE LIMITÉE

NESCAFÉ  
Dolce  
Gusto

Ce produit Nescafé Dolce Gusto est garanti contre les défauts des matériaux et de fabrication deux ans à compter de la date d'achat. Au cours de cette période, un produit Nescafé Dolce Gusto présumé défectueux sera examiné par Nescafé Dolce Gusto et s'il est reconnu comme tel, il sera réparé ou remplacé, à la discrétion de Nescafé Dolce Gusto, sans aucuns frais pour le client. Si un produit de remplacement est envoyé, la durée de la garantie reste celle fournie avec le produit original. Cette garantie ne s'applique pas si le défaut est dû à une mauvaise utilisation du produit par l'acheteur ou par l'utilisateur, à une négligence, à un mauvais suivi des instructions de Nescafé Dolce Gusto, ou encore à l'utilisation du produit avec un courant ou un voltage différent de celui indiqué sur le produit. Elle ne s'applique pas non plus en cas de dommages causés par l'usure et l'usage, de modification ou de réparation non autorisée par Nescafé Dolce Gusto, ni en cas d'utilisation commerciale, ni si l'appareil n'a pas été adéquatement détartré.

LES GARANTIES EXPOSÉES DANS CE LIVRET SONT EXCLUSIVES À CE PRODUIT ET AUCUNE AUTRE GARANTIE, EXPLICITE OU IMPLICITE, N'EST DÉLIVRÉE NI AUTORISÉE PAR NESCAFÉ DOLCE GUSTO POUR CE PRODUIT, Y COMPRIS, MAIS NON DE FAÇON LIMITATIVE, TOUTE GARANTIE DE QUALITÉ MARCHANDE OU AUTRE POUR UNE UTILISATION SPÉCIFIQUE.

Puisque certaines provinces ne permettent pas de restreindre la durée d'une garantie ou de stipuler des exclusions quant aux dommages directs ou indirects, les restrictions ci-dessus peuvent ne pas s'appliquer. Cette garantie vous donne des droits légaux précis et les droits supplémentaires peuvent varier d'une province à l'autre. Si vous pensez que votre produit est défectueux, apportez-le (ou envoyez-le port payé) avec votre preuve d'achat au Centre de service Nescafé Dolce Gusto agréé le plus près. (Pour obtenir l'adresse du Centre de service Nescafé Dolce Gusto agréé le plus près, visitez le site Web de Nescafé Dolce Gusto ou communiquez avec le service à la clientèle Nescafé Dolce Gusto de votre pays - voir la liste ci-dessous.) Si vous envoyez le produit, veuillez y joindre une lettre nous expliquant la nature de votre réclamation et du défaut revendiqué.

**Vous trouverez l'adresse des Centres de service Nescafé Dolce Gusto agréés en visitant le site Web [www.dolce-gusto.ca](http://www.dolce-gusto.ca).**

Si vous expédiez le produit au Centre de service, veuillez y joindre une lettre expliquant le problème ainsi qu'une copie de la preuve d'achat, et inscrire une adresse de retour valide sur l'extérieur de la boîte (les boîtes postales ne sont pas acceptées). Si la garantie du produit est expirée ou ne peut être validée, le Centre de service vous fera parvenir une estimation des réparations pour approbation.

### SERVICE À LA CLIENTÈLE

Si vous avez des questions supplémentaires, veuillez communiquer avec notre Centre de service à la clientèle. Il est préférable d'avoir le produit à portée de la main au moment de votre appel ainsi que le numéro de référence, habituellement situé sur la base du produit.

### CANADA

Téléphone	1-888-809-9267
Heures d'ouverture	Lundi au vendredi de 9 h 00 à 18 h 00 (HNE)

Toute correspondance doit être adressée à  
Nescafé Dolce Gusto  
Centre d'aide aux consommateurs  
PO Box 186  
Cobourg ON K9A 4K5  
Canada



NESCAFÉ  
Dolce  
Gusto

T-fal®



 **Customer service:**  
# 1 888 809-9267  
Monday - Friday  
9 am to 6 pm, Eastern time  
[www.dolce-gusto.ca](http://www.dolce-gusto.ca)

 **Service après-vente:**  
# 1 888 809-9267  
Du lundi au vendredi,  
de 9 h à 18 h, heure de l'Est  
[www.dolce-gusto.ca](http://www.dolce-gusto.ca)