

# Tefal®

## OptiGrill Elite XL

FR  
NL  
DE  
EN  
IT  
ES  
PT  
EL



Mode d'emploi - Instructies voor gebruik -  
Bedienungsanleitung - Instructions for use - Istruzioni d'uso -  
Instrucciones de uso - Manual de instruções - Οδηγίες χρήσης

# CONSIGNES DE SÉCURITÉ PRÉCAUTIONS IMPORTANTES

**Utilisation, entretien, nettoyage et installation du produit : pour votre sécurité, merci de vous référer aux différents paragraphes de cette notice et aux pictogrammes correspondants.**

Cet appareil est uniquement destiné à un usage domestique. Il n'a pas été conçu pour être utilisé dans les cas suivants qui ne sont pas couverts par la garantie :

- dans les coins de cuisine réservés au personnel dans des magasins, bureaux et autres environnements professionnels,
- dans les fermes,
- par les clients des hôtels, motels et autres environnements à caractère résidentiel,
- dans les environnements de type chambres d'hôtes.

Enlever tous les emballages, autocollants ou accessoires divers à l'intérieur comme à l'extérieur de l'appareil.

Cet appareil n'est pas prévu pour être utilisé par des personnes (y compris les enfants) dont les capacités physiques, sensorielles ou mentales sont réduites, ou des personnes dénuées d'expérience ou de connaissance, sauf si elles ont pu bénéficier, par l'intermédiaire d'une personne responsable de leur sécurité, d'une surveillance ou d'instructions préalables concernant l'utilisation de l'appareil.

Il convient de surveiller les enfants pour s'assurer qu'ils ne doivent pas jouer avec l'appareil et utiliser l'appareil comme un jouet.

Ne jamais utiliser l'appareil sans surveillance.

 La température des surfaces accessibles peut être élevée lorsque l'appareil est en fonctionnement.

Ne pas toucher les surfaces chaudes de l'appareil.

Cet appareil n'est pas destiné à être mis en fonctionnement au moyen d'une minuterie extérieure ou par un système de commande à distance séparé.

Dérouler entièrement le cordon.

Si le câble d'alimentation est endommagé, il doit être remplacé par le fabricant, son service après-vente ou une personne de qualification similaire afin d'éviter un danger.

Si une rallonge électrique est utilisée, elle doit être de section équivalente et avec prise de terre incorporée. Prendre toutes les précautions nécessaires afin que personne ne s'entrave dedans.

Ne brancher l'appareil que sur une prise avec terre incorporée.

Vérifier que l'installation électrique est compatible avec la puissance et la tension indiqués sous l'appareil.

Cet appareil ne doit pas être immergé. Ne jamais plonger dans l'eau l'appareil ni le cordon.

Cet appareil peut être utilisé par des enfants à partir de 8 ans et plus et par des personnes ayant des capacités physiques, sensorielles ou mentales réduites ou un manque d'expérience et de connaissances à condition qu'elles aient reçu une supervision ou des instructions concernant l'utilisation de l'appareil en toute sécurité et qu'elles comprennent les dangers encourus. Le nettoyage et l'entretien par l'utilisateur ne doivent pas être effectués par des enfants, sauf s'ils ont plus de 8 ans et qu'ils sont surveillés.

Maintenir l'appareil et son cordon hors de portée des enfants de moins de 8 ans.

**ATTENTION** : Ne pas faire chauffer ou préchauffer le grill sans les 2 plaques à l'intérieur.

Ajout de la phrase sur les éclaboussures?

## À faire

- Lire attentivement et garder à portée de main les instructions de cette notice, communes aux différentes versions suivant les accessoires livrés avec votre appareil.
- Si un accident se produit, passez de l'eau froide immédiatement sur la brûlure et appelez un médecin si nécessaire.
- Lors de la première utilisation, lavez les plaques (voir paragraphe 11), versez un peu d'huile sur les plaques et les essuyez avec un chiffon doux.
- Veillez à l'emplacement du cordon avec ou sans rallonge, prendre toutes les précautions nécessaires afin de ne pas gêner la circulation des convives autour de la table de telle sorte que personne ne s'entrave dedans.
- Les fumées de cuisson peuvent être dangereuses pour les animaux ayant un système de respiration particulièrement sensible, comme les oiseaux. Nous conseillons aux propriétaires d'oiseaux de les éloigner du lieu de cuisson.
- Toujours mettre l'appareil hors de portée des enfants.
- Vérifiez que les deux faces de la plaque soient bien nettoyées avant utilisation.
- Pour éviter de détériorer les plaques, utilisez celles-ci uniquement sur l'appareil pour lequel elles ont été conçues (ex : ne pas les mettre dans un four, sur le gaz ou une plaque électrique...).

- Veillez à ce que les plaques soient stables, bien positionnées et bien clipsées sur la base de l'appareil. N'utilisez que les plaques fournies ou acquises auprès du centre de service agréé.
- Pour préserver le revêtement des plaques de cuisson, toujours utiliser une spatule plastique ou en bois.
- N'utiliser que les accessoires fournis avec l'appareil ou achetés à un centre de service autorisé. Ne pas les utiliser avec d'autres appareils.

## À ne pas faire

- Ne pas utiliser l'appareil à l'extérieur.
- Ne jamais brancher l'appareil lorsqu'il n'est pas utilisé.
- Pour éviter la surchauffe de l'appareil, ne pas le placer dans un coin ou contre un mur.
- Ne jamais placer votre appareil directement sur un support fragile (table en verre, nappe, meuble verni...) ou sur un support de type nappe plastique.
- Ne jamais placer l'appareil sous un meuble fixé au mur ou une étagère ou à côté de matériaux inflammables comme des stores, des rideaux, des tentures.
- Ne pas placer l'appareil sur ou près de surfaces glissantes ou chaudes, ni laisser le cordon pendre au-dessus d'une source de chaleur (plaques de cuisson, cuisinière à gaz...).
- Ne pas poser d'ustensiles de cuisson sur les surfaces de cuisson de l'appareil.
- Ne pas couper directement sur les plaques.
- Ne jamais utiliser d'éponge métallique, ni de poudre à récurer afin de ne pas endommager la surface de cuisson (revêtement antiadhésif).
- Ne pas déplacer l'appareil durant son utilisation.
- Ne pas porter l'appareil par la poignée ou les fils métalliques.
- Ne jamais utiliser l'appareil à vide.
- Ne jamais interposer de feuille d'aluminium ou tout autre objet entre les plaques et les aliments à cuire.
- Ne pas retirer le plateau de récupération de graisses pendant la cuisson. Si le plateau de récupération de graisse est plein durant la cuisson, laissez refroidir l'appareil avant de le vider.
- Ne pas poser la plaque chaude sous l'eau ou sur une surface fragile.
- Pour conserver les qualités anti-adhésives du revêtement, évitez de laisser chauffer trop longtemps à vide.
- Les plaques ne doivent jamais être manipulées à chaud.
- Ne pas faire de cuisson en papillote.
- Pour éviter d'abîmer votre appareil, ne jamais réaliser de recettes flambées sur celui-ci.
- Ne jamais interposer de feuille d'aluminium ou tout autre objet entre les plaques et les résistances.
- Ne jamais faire chauffer ou faire des cuissons en position « grill ouvert ».
- Ne jamais faire chauffer l'appareil sans les plaques de cuisson.

## Conseils/Informations

- Merci d'avoir acheté cet appareil, destiné uniquement à un usage domestique.
- Pour votre sécurité, cet appareil est conforme aux normes et réglementations applicables (Directives Basse Tension, Compatibilité Electromagnétique, Matériaux en contact des aliments, Environnement...).
- Lors de la première utilisation, un léger dégagement d'odeur ou de fumée peut se produire.
- Pour nettoyer les plaques de cuisson, utiliser une éponge, de l'eau chaude et du liquide vaisselle.
- Notre société se réserve le droit de modifier à tout moment, dans l'intérêt du consommateur, les caractéristiques ou composants de ses produits.
- Tout aliment liquide ou solide entrant en contact avec les pièces marquées du logo  ne peut être consommé.

- Si les aliments sont trop épais, le système de sécurité interdit la mise en marche de l'appareil.
- La résistance ne se nettoie pas. Si elle est vraiment sale, attendre son complet refroidissement et la frotter avec un chiffon sec.
- Le tableau de bord est un élément fragile : le nettoyer, l'essuyer et le sécher, uniquement avec un chiffon sec et doux. Ne pas le nettoyer avec une éponge mouillée, cela risquerait d'endommager ses fonctions.
- Le tableau de bord est un élément fragile : le nettoyer, l'essuyer et le sécher, uniquement avec un chiffon sec et doux. Ne pas le nettoyer avec une éponge mouillée, cela risquerait d'endommager ses fonctions.

## Environnement



### Participons à la protection de l'environnement !

- ① Votre appareil contient de nombreux matériaux valorisables ou recyclables.
- ➔ Confiez celui-ci dans un point de collecte ou à défaut dans un centre service agréé pour que son traitement soit effectué.

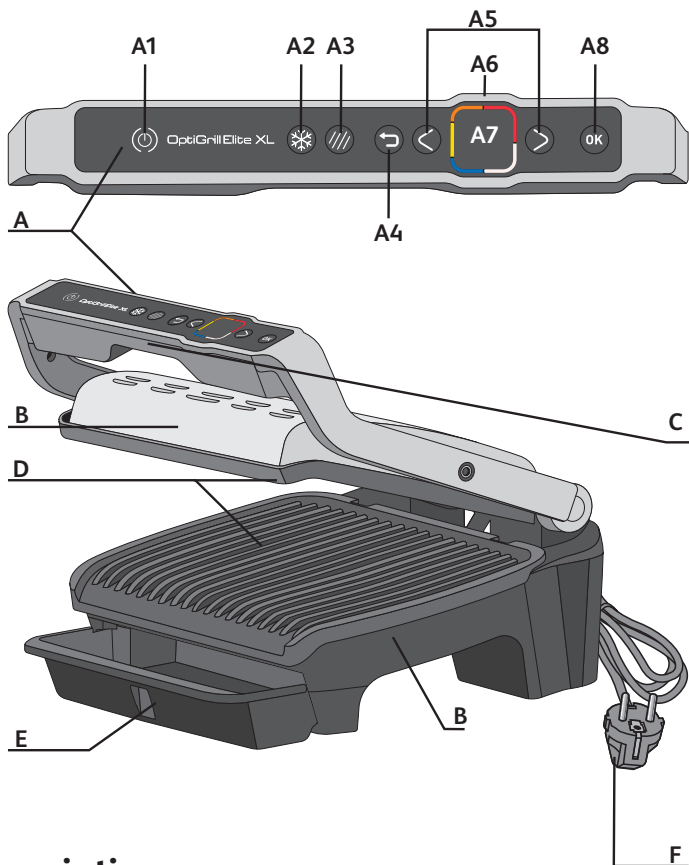

## Description

- |                                      |  |   |
|--------------------------------------|--|---|
| <b>A</b> Tableau de bord             | <b>A5</b> Touches de réglage et de navigation                | <b>B</b> Corps de l'appareil            |
| <b>A1</b> Bouton marche/arrêt        | <b>A6</b> Indicateur de préchauffage et de niveau de cuisson | <b>C</b> Poignée                        |
| <b>A2</b> Fonction aliment congelé   | <b>A7</b> Ecran d'affichage                                  | <b>D</b> Plaques de cuisson             |
| <b>A3</b> Fonction marquage intensif | <b>A8</b> Bouton OK  | <b>E</b> Plateau de récupération de jus |
| <b>A4</b> Bouton retour              |  | <b>F</b> Cordon d'alimentation          |

Les touches sont actives uniquement lorsqu'elles sont allumées.

# 16 programmes automatiques de cuisson

FR

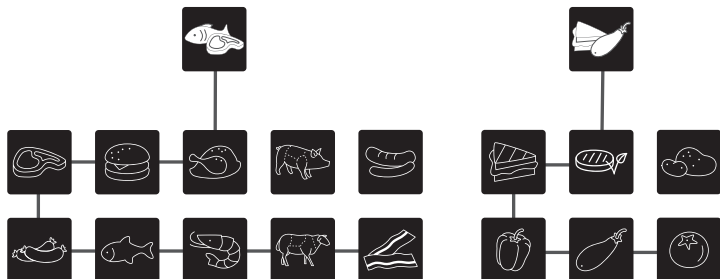

## Deux options de cuissons possibles en mode automatique



Fonction Aliment Congelé



Fonction Marquage Intensif

## Un mode manuel

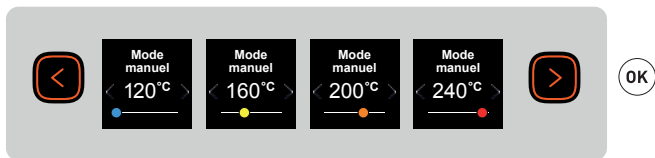

## Un bouton retour



Si vous êtes rentrés dans un sous menu et que vous souhaitez revenir au menu principal, appuyez une fois sur le bouton retour.  
Si vous avez choisi le mauvais programme, appuyez deux fois sur le bouton retour pour annuler la fonction.

# 1 Préparation

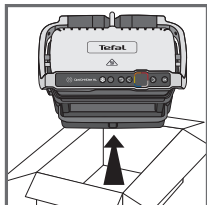
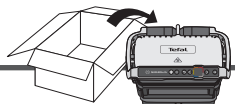

1

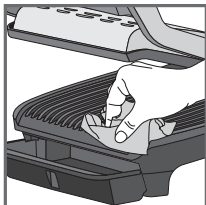

2

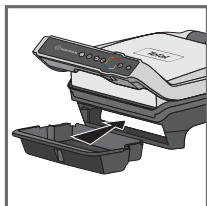

3



4

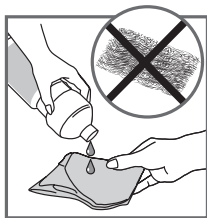

5



6

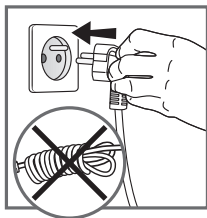

7

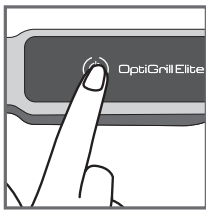

8

1 Enlevez tous les emballages, autocollants ou accessoires divers à l'intérieur comme à l'extérieur de l'appareil.

2 Avant la première utilisation, nettoyez soigneusement les plaques avec de l'eau chaude et du liquide vaisselle, rincez et séchez soigneusement.

3-4 Installez le plateau amovible de récupération de jus à l'avant de l'appareil.

5 Si vous le souhaitez, pour obtenir de meilleurs résultats et pour améliorer l'efficacité de la surface antiadhésive, vous pouvez essuyer les plaques de cuisson à l'aide d'un essuie-tout imprégné d'un peu d'huile de cuisson.

6 Éliminez tout surplus d'huile à l'aide d'un essuie-tout propre.

7 Assurez-vous que les plaques supérieures et inférieures sont correctement positionnées dans le produit. Ne lancez pas le préchauffage sans plaques. Branchez l'appareil sur le secteur. (Notez que le cordon doit être entièrement déroulé).

8 Appuyez sur le bouton marche / arrêt.

**Attention :** Assurez vous qu'il n'y ait pas d'aliments entre les plaques.



## 2 Première utilisation

9 Choisissez votre langue en utilisant les flèches puis appuyez sur ok.



9

## 3 Marche/Arrêt

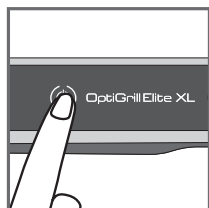

10

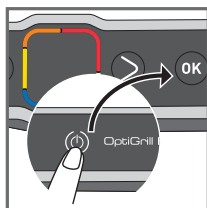

11

10 Allumez

11 Pour éteindre le grill appuyez une fois sur le bouton marche/arrêt et une fois sur le bouton OK pour valider l'arrêt de l'appareil.

## 4 Fonction Aliment Congelé - en mode automatique

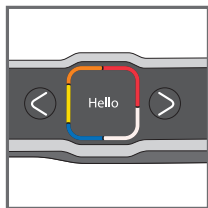

Bonjour

12



13

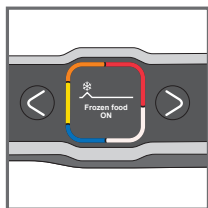

Aliment congelé activé

14

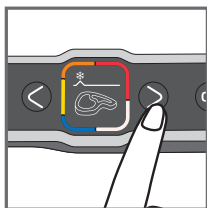

15

**13-15** Fonction Aliment Congelé à activer avant de lancer le préchauffage, lors de la sélection du mode automatique, si les aliments à cuire sont congelés/surgelés.

En cas d'oubli d'activation de l'option, utiliser la touche "retour" et recommencer les étapes.

Cette fonction n'est disponible qu'en mode automatique, pas en mode manuel.

## 5 Fonction Marquage Intensif - en mode automatique



FR

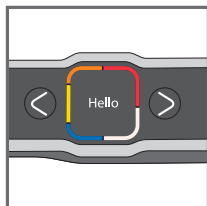

Bonjour

16



17

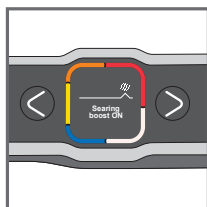

Marquage intensif activé

18

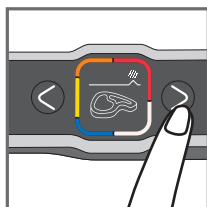

19

**17-19** Fonction Marquage Intensif à activer avant de lancer le préchauffage, lors de la sélection du mode automatique, si vous souhaitez un marquage plus important des aliments à cuire.

En cas d'oubli d'activation de l'option, utiliser la touche "retour" et recommencer les étapes.

Cette fonction n'est disponible qu'en mode automatique, pas en mode manuel.

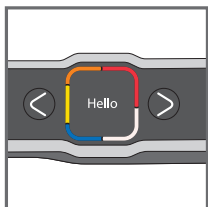

Bonjour

20

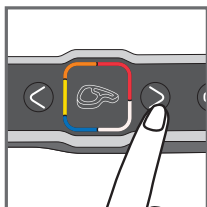

21

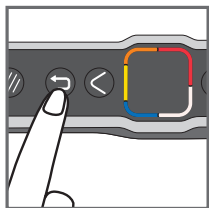

22

En cas de doute sur le mode de cuisson à utiliser, reportez-vous aux guides de cuisson page 22.

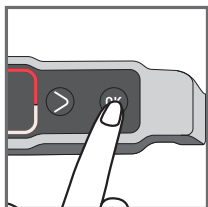

23



Préchauffe en cours

24

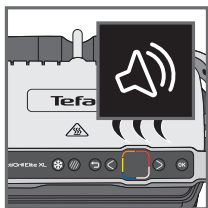

25

- 21 Sélectionnez le mode de cuisson approprié en fonction du type d'aliment à cuire.

**Conseil, notamment pour la viande :** les résultats de cuisson des programmes prédéfinis peuvent varier selon l'origine, la coupe et la qualité de l'aliment à cuire, les programmes ayant été définis et testés avec des aliments de bonne qualité.

De même, l'épaisseur de la viande doit être prise en compte lors de la cuisson; vous ne devez pas faire cuire d'aliments de plus de 4 cm d'épaisseur.

- 22 Si vous souhaitez changer de programme, il est possible de revenir au menu principal en appuyant une fois sur le bouton retour.

- 23 Appuyez sur le bouton «OK» : l'appareil commence le préchauffage.

**Remarque :** si vous sélectionnez un programme par erreur, utiliser la touche "retour".

- 24 Attendez 4 à 7 minutes. Lorsque le préchauffage a démarré, si vous souhaitez changer le programme choisi, appuyez sur le bouton retour puis valider avec le bouton OK pour revenir au menu principal. Un deuxième appui sur le bouton retour annule la fonction.

- 25 Un signal sonore retentit pour signaler que le préchauffage est terminé.

**Commentaire :** si l'appareil demeure fermé trop longtemps une fois le préchauffage terminé, le système de sécurité mettra l'appareil hors tension.

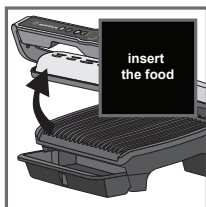

Mettez vos aliments

26

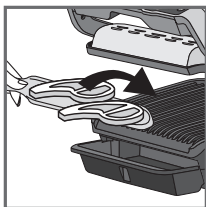

27

26-27

Une fois le préchauffage terminé, vous pouvez insérer vos ingrédients. Soulevez le couvercle du grill et mettez les aliments dans le grill.

**Commentaire :** si l'appareil demeure ouvert trop longtemps, le système de sécurité mettra l'appareil hors tension automatiquement.



28



Pour démarrer la cuisson

29

28-30

L'appareil calcule automatiquement le cycle de cuisson (temps et température) selon la quantité et l'épaisseur des aliments.

Fermez l'appareil pour que le cycle de cuisson commence.

**Remarque pour les aliments très fins, par exemple du bacon :** Le bouton "OK" s'allume. Appuyez alors sur "OK" pour s'assurer que l'appareil reconnaisse bien l'aliment et que le cycle de cuisson démarre.



Début de cuisson

30



31

La flèche se déplace le long de l'indicateur du niveau de cuisson et lorsqu'elle atteint un niveau de cuisson, le niveau est affiché et un signal sonore retentit.

NB: les niveaux de cuisson sont pré programmés pour chaque mode automatique.

Pendant la cuisson, un signal sonore avertit l'utilisateur chaque fois qu'un niveau de cuisson est atteint (p. ex., saignant/jaune).

Selon le degré de cuisson, l'indicateur change de couleur et la flèche de progression de cuisson se déplace sur l'écran.

Notez, notamment pour la viande, qu'il est normal que les résultats de cuisson varient selon le type, la qualité et l'origine de la nourriture.



32

**Bien cuit dans 01:35**

33

**32-33** Vous avez la possibilité de connaître à tout moment le temps restant pour atteindre les différents niveaux de cuisson. Appuyez sur la flèche de droite si vous souhaitez voir dans combien de temps le niveau de cuisson suivant sera atteint. Attention, il ne s'agit pas d'une sélection de niveaux de cuisson. Le grill continue de cuire jusqu'au dernier niveau de cuisson et prévient à chaque niveau.

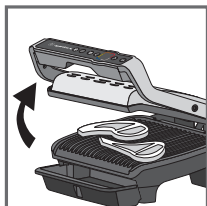

34

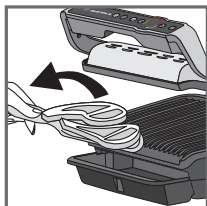

35

**34-35** Lorsque le niveau de cuisson correspondant à votre choix apparaît et que le signal sonore retentit, ouvrez l'appareil et retirez vos aliments.

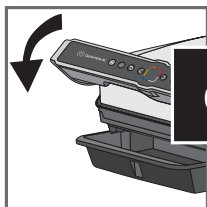

36

**Pour arrêter la cuisson**

37

**36-37** Abaissez le couvercle. L'écran vous demande confirmation pour stopper la cuisson. Valider par OK si tous les aliments ont été retirés, sinon laisser se poursuivre la cuisson.

Si vous souhaitez réaliser une nouvelle cuisson, vous référer au paragraphe 7.

**Commentaire :** le système de sécurité mettra l'appareil hors tension automatiquement si aucun programme n'est sélectionné au bout d'un certain temps.

## 7 Comment réaliser une seconde cuisson

### Seconde cuisson du même type d'aliment

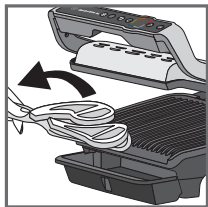

38

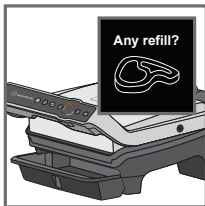

Nouvelle cuisson ?

39

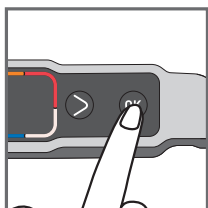

40



Préchauffe en cours

41

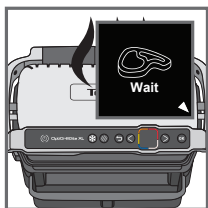

Attendez

42

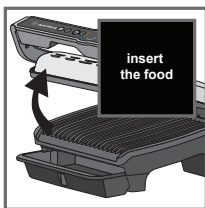

Mettez vos aliments

43

**38-39** A la fin de la première cuisson, un écran "nouvelle cuisson" apparaît. Si vous souhaitez griller le même type d'aliment, appuyez sur OK.

**40** L'appareil commence le préchauffage.

**41** Attendez la fin du préchauffage.

**42** Mettez les aliments dans le grill.

**43** Suivez ensuite les étapes de 27 à 37.

### Seconde cuisson d'un ingrédient différent

Une fois que la cuisson de vos premiers ingrédients est terminée :

1. Assurez-vous que l'appareil est fermé et qu'il n'y a pas d'aliments à l'intérieur.
2. Sélectionnez le mode ou programme de cuisson approprié.
3. Appuyez sur le bouton «OK» pour commencer le préchauffage. Pendant le préchauffage, l'indicateur du préchauffage est indiqué sur l'écran.
4. Une fois le préchauffage terminé, un signal sonore retentit et l'information de fin de préchauffage est indiquée sur l'écran.

5. L'appareil est prêt à être utilisé une fois le préchauffage terminé. Soulevez le couvercle du grill et mettez les aliments à l'intérieur de l'appareil. Suivez ensuite les étapes de 27 à 37.

### Important :

- Veuillez noter que le préchauffage est obligatoire pour chaque cuisson.
- Rappel : avant de lancer le préchauffage, assurez-vous que l'appareil est fermé et qu'il n'y a pas d'aliments à l'intérieur.
- Attendez ensuite que le préchauffage soit terminé avant d'ouvrir le grill et de mettre des aliments à l'intérieur.

**Remarque :** si le nouveau cycle de préchauffage est lancé immédiatement après la fin du cycle précédent, le temps de préchauffage sera plus court.

## 8 Cuisson en mode manuel

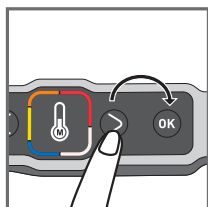

44

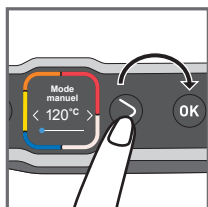

45

- 44 Sélectionnez le mode manuel et appuyez sur OK pour valider.

- 45 Sélectionnez la température souhaitée à l'aide des touches de réglages.

Appuyez sur OK pour valider la température sélectionnée.

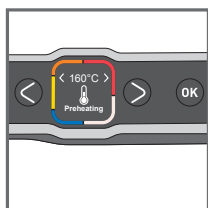

46

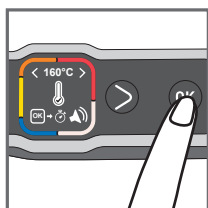

47

- 46 Attendez la fin du préchauffage.

- 47 Une fois le préchauffage terminé, appuyez sur OK pour lancer le timer.

**Remarque :** le temps de cuisson peut également être réglé dès le début du préchauffage.

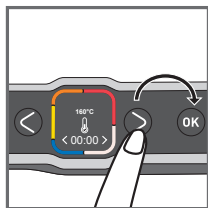

48

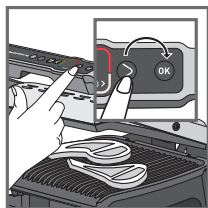

49

- 48 Appuyez sur les touches de réglage pour sélectionner le temps de cuisson souhaité.

- 49 Insérez vos aliments et appuyez sur OK pour lancer la cuisson et le décompte du temps.

A tout moment, appuyer sur "OK" pour régler la température et/ou le temps.



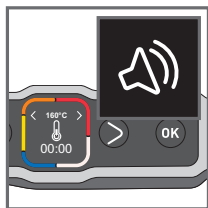

50

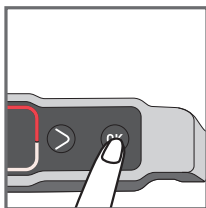

Pour arrêter la cuisson

51

**50-51** Un signal sonore vous indique quand le temps de cuisson est terminé. Retirez vos aliments.

Appuyez sur OK pour arrêter la cuisson et retirez vos aliments

## 9 Commentaires

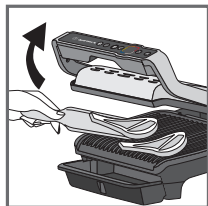

52

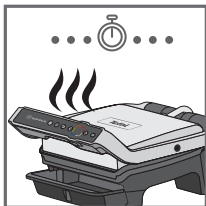

53

**52-54**

En fonction des préférences personnelles ouvrez le grill et retirez les aliments ayant atteint le niveau de cuisson souhaité, puis refermez le grill pour poursuivre la cuisson des autres aliments. Le programme poursuivra le cycle de cuisson jusqu'au dernier niveau de cuisson du mode sélectionné.



Retirez votre aliment

54



Risque de surcuisson

55

**55 Commentaire :** le système de sécurité mettra l'appareil hors tension automatiquement après un certain laps de temps.

## 10 Fin d'utilisation

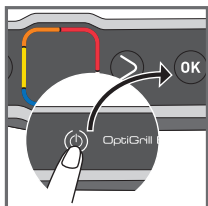

56

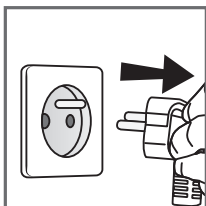

57

**56** Appuyez sur le bouton marche/arrêt puis valider en appuyant sur le bouton OK.

**57** Débranchez l'appareil.

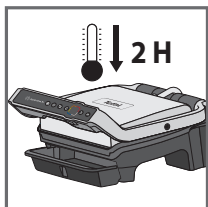

58

**58** Laissez refroidir pendant au moins 2 heures.

Pour éviter des brûlures accidentelles, laissez le grill refroidir complètement avant de procéder à son nettoyage.

# 11 Nettoyage



FR

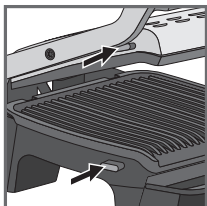

59

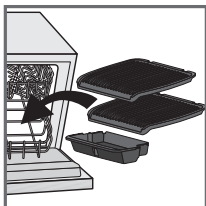

60

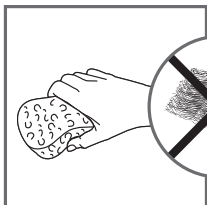

61

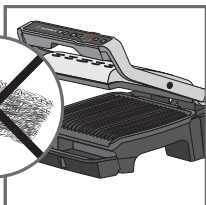

62

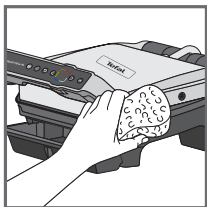

63

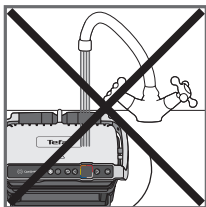

64

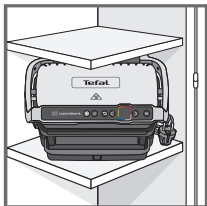

65

**59** Avant le nettoyage, débloquez et retirez les plaques pour éviter d'endommager la surface de cuisson.

**60** Le plateau de récupération de jus et les plaques de cuisson peuvent aller au lave-vaisselle. L'appareil et son cordon ne doivent jamais être mis au lave-vaisselle. Les éléments chauffants (les résistances) ne doivent jamais être nettoyés après que les plaques aient été enlevées. S'ils sont très sales, attendez que l'appareil ait complètement refroidi et nettoyez-les à l'aide d'un chiffon sec.

**61-62**

Pour faciliter le nettoyage des plaques, laissez tremper 1h dans de l'eau chaude et du liquide vaisselle, puis rincez-les abondamment pour enlever tout résidu. Essuyez-les soigneusement avec un essuie-tout. N'utilisez pas de tampon à recurer métallique, de laine d'acier ou de produits de nettoyage abrasifs pour nettoyer toute partie du gril, utilisez uniquement des tampons de nettoyage en nylon ou non métalliques.

Videz le plateau de récupération du jus et lavez-le dans de l'eau chaude légèrement savonneuse, puis essuyez-le soigneusement à l'aide d'un essuie-tout.

**63** Pour nettoyer le couvercle du gril, passez une éponge imprégnée d'eau chaude et essuyez avec un chiffon doux et sec. Pour nettoyer le panneau de commande, utiliser uniquement un chiffon doux et sec.



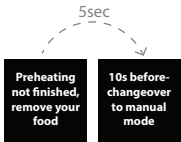

**64** N'immergez pas le boîtier du gril dans l'eau ou tout autre liquide.

**65** Assurez-vous toujours que le gril est propre, froid et sec avant de le ranger. Toute autre réparation doit être effectuée par un représentant de service agréé.

**GUIDE DE DEPANNAGE ELITE**



Problème	Cause	Solution
Changement de langue		Brancher le Grill, Appuyer sur ON, puis immédiatement sur la touche Frozen (pendant que l'écran affiche «Bonjour»)
	Le temps de préchauffage n'était pas complètement terminé. Le gril a été ouvert et les aliments déposés sur la plaque avant la fin du préchauffage.	Il est possible de cuire les aliments, mais vous devez contrôler la cuisson car le gril est passé en mode manuel. La température peut être ajustée. Ou Ouvrez le gril, enlevez les aliments, fermez le gril correctement et attendez jusqu'à la fin du préchauffage.
Je n'arrive pas à éteindre mon appareil	Manque un second appui ou temps trop long entre les 2 appuis.	Appuyer une fois sur le bouton marche/arrêt puis valider par OK
Err 1 a Err 8	L'appareil a été rangé ou utilisé dans une pièce trop froide. Appareil en surchauffe.	Débranchez l'appareil et attendez quelques minutes. Rebranchez à nouveau le gril et appuyez sur Marche. Si le problème persiste, contactez le service client.
Err 9 a Err 13	Défaillance de l'appareil.	Débranchez l'appareil et contactez le service client.
L'appareil s'arrête tout seul pendant le cycle de préchauffage ou de cuisson.	L'appareil est resté ouvert trop longtemps en cours de cuisson. L'appareil est demeuré au repos trop longtemps après la fin du préchauffage ou du maintien au chaud.	Débranchez l'appareil et attendez quelques minutes. Rebranchez ensuite votre appareil et mettez-le en marche.

## GUIDE DE DEPANNAGE ELITE

Problème	Cause	Solution
	Demande de confirmation de fin de cuisson	2 solutions : Appuyer sur OK si tous les aliments ont été retirés Ou Ne pas appuyer sur OK et laisser cuire si il reste des aliments à cuire
	Aliment non détecté car trop fin	Appui sur OK pour démarrer la cuisson
	Aliment trop épais	2 solutions : Appuyer sur OK pour continuer la cuisson en mode manuel Ou Retirer les aliments pour diminuer l'épaisseur, afin de permettre une cuisson en mode automatique
Je ne parviens pas à régler un temps en mode manuel	L'écran est resté sur le réglage température	Appuyer une fois sur Ok pour aller sur le réglage temps puis régler avec les flèches. Valider par OK.  

16 PROGRAMMES AUTOMATIQUES					
PROGRAMMES AUTOMATIQUES		INDICATEUR DU NIVEAU DE CUISSON			
MENUS					
	Boeuf	Bleu	Saignant	À point	Bien cuit
	Poulet	-	-	-	Bien cuit
	Saucisse	-	-	-	Bien cuit
	Bacon	-	-	À point	Croustillant
	Steak haché (burger)	-	Saignant	À point	Bien cuit
	Panini	-	Légèrement cuit	Toasté	Croustillant
	Poisson	-	À point	À point plus	Bien cuit
	Fruits de mer	-	À point	À point plus	Bien cuit
	Pomme de terre	-	-	-	Fondant
	Poivron	-	-	Croquant	Fondant
	Aubergine	-	-	-	Grillé
	Tomate	-	-	Croquant	Fondant
	Porc	-	-	À point plus	Bien cuit
	Saucisse précuite	-	-	-	Fondant
	Agneau	-	À point	À point plus	Bien cuit
	Steak végétal	-	-	-	Fondant

## CONSEIL DE CUISSON

PRODUITS	PROGRAMME DE CUISSON	CONSEIL DE CUISSON
Filet mignon de porc (sans os), poitrine de porc		Bien cuit *
Bratwurst (porc précuit)		220°C / 8 min 30
Rindswurst (boeuf précuit)		220°C / 8 min 30
Nürnberger Wurst (porc précuit)		220°C / 4 min 30

## MODE MANUEL SPÉCIAL

## LÉGUME OU FRUIT

De 180°C à 195°C	De 220°C à 235°C	De 225°C à 270°C
-	-	Courgette (tranches)
-	-	Asperge
-	-	Champignon
-	Oignon	-
Brocoli	-	-
Mini-carotte	-	-
-	Fenouil	-
Patate douce (tranches)	-	-
-	Pomme (tranches)	-
-	Ananas	-
-	Pêche	-

## CONSEIL DE PRÉPARATION

Pour des grillades plus marquées, il est préférable de retourner l'aliment grillé avant de le servir à vos convives.

PRODUITS	CONSEIL DE PRÉPARATION
POMME DE TERRE	<ul style="list-style-type: none"> <li>• Tranches dans la longueur</li> <li>• Ajouter de l'huile sur les ingrédients pour une meilleure cuisson</li> </ul>
POIVRON	<ul style="list-style-type: none"> <li>• Coupé en deux dans la longueur</li> </ul>
AUBERGINE	<ul style="list-style-type: none"> <li>• Tranches dans la longueur</li> <li>• Ajouter de l'huile sur les ingrédients pour une meilleure cuisson</li> </ul>
TOMATE	<ul style="list-style-type: none"> <li>• Utiliser des tomates de forme ronde</li> <li>• Utiliser des tomates qui ne sont pas trop mûres</li> <li>• Couper en deux dans la largeur</li> <li>• Pour une cuisson optimale, placer le côté arrondi de la tomate découpée en 2 sur la plaque inférieure du gril.</li> </ul>
PORC	<ul style="list-style-type: none"> <li>* Utiliser la fonction marquage intensif si l'épaisseur dépasse 20 mm.</li> </ul>



# VEILIGHEIDSVOORSCHRIFTEN

## BELANGRIJKE VOORZORGSMAATREGELEN

**Gebruik, onderhoud, reiniging en installatie van het product: raadpleeg voor uw eigen veiligheid de verschillende secties in deze handleiding en de overeenkomstige pictogrammen.**

Uw apparaat is uitsluitend bedoeld om gebruikt te worden voor huishoudelijk gebruik. Deze is niet ontworpen voor een gebruik in de volgende gevallen, waarvoor de garantie niet geldig is:

- in kleinschalige personeelskeukens in winkels, kantoren en andere arbeidsomgevingen,
- door gasten van hotels, motels of andere verblijfsvormen.

Verwijder de volledige verpakking, de stickers en diverse accessoires, zowel aan de binnenkant als aan de buitenkant van het apparaat.

Dit apparaat is niet bedoeld om zonder hulp en/of toezicht gebruikt te worden door kinderen of andere personen indien hun fysieke, zintuiglijke of mentale vermogen hen niet in staat stellen dit apparaat op een veilige wijze te gebruiken. Er moet toezicht zijn op kinderen zodat zij niet met het apparaat kunnen spelen. Dit apparaat mag gebruikt worden door kinderen vanaf 8 jaar en door personen met beperkte fysieke, zintuiglijke of mentale capaciteiten of personen zonder ervaring of kennis, indien ze via een persoon die verantwoordelijk is voor hun veiligheid onder toezicht staan of voorafgaand instructies kregen over het gebruik van het toestel en op de hoogte zijn van de mogelijke risico's.

Kinderen mogen niet met het apparaat spelen. Schoonmaak en onderhoudswerkzaamheden mogen alleen worden verricht door kinderen boven de 8 jaar die onder toezicht staan.

Let erop dat kinderen niet met het apparaat spelen of dit als speelgoed gebruiken.

Het apparaat nooit zonder toezicht gebruiken.

 Wanneer het apparaat aanstaat, kan de temperatuur hoog oplopen.

Raak de hete delen van het apparaat niet aan.

**NL** Dit apparaat is niet geschikt om gebruikt te worden in combinatie met een tijdschakelaar of afstandsbediening.

Rol het snoer volledig uit.

Wanneer het netsnoer is beschadigd dient deze te worden vervangen door de fabrikant, zijn servicedienst of een gelijkwaardig gekwalificeerd persoon om een gevaarlijke situatie te voorkomen.

Als er een elektrisch verlengsnoer gebruikt wordt, moet deze minimaal van een gelijke doorsnede zijn en met een geïntegreerde geaarde stekker; neem de nodige voorzorgsmaatregelen om te voorkomen dat men hier over struikelt. Sluit het apparaat uitsluitend aan op een geaard stopcontact.

Controleer of de elektrische installatie geschikt is voor de op het apparaat aangegeven stroomsterkte en spanning.

Nooit het apparaat en het snoer in water onderdompelen.

Dit apparaat mag worden gebruikt door kinderen vanaf 8 jaar en door personen met beperkte lichamelijke, zintuiglijke of geestelijke vermogens of zonder ervaring en kennis, op voorwaarde dat dit onder toezicht gebeurt of zij instructies hebben gekregen inzake het veilige gebruik van het apparaat en dat zij op de hoogte zijn van de risico's waaraan zij zijn blootgesteld. De reiniging en het onderhoud mag niet worden uitgevoerd door kinderen, tenzij ze minstens 8 jaar oud zijn en bovendien worden begeleid.

Houd het apparaat en het netsnoer buiten het bereik van kinderen jonger dan 8 jaar.

**OPGELET:** De grill niet laten opwarmen of voorverwarmen zonder de twee binnenste platen.

# Doen

- Lees de instructies van deze handleiding aandachtig door en houd ze binnen handbereik; deze handleiding betreft de verschillende modellen, afhankelijk van de meegeleverde accessoires.
- Als iemand zich brandt, koel de brandplek dan onmiddellijk met koud water en schakel, indien nodig, de hulp in van een huisarts.
- Reinig de platen bij het eerste gebruik (zie paragraaf 11). Giet er een beetje olie over en wrijf droog met een zachte doek.
- Zorg ervoor dat u het snoer, met of zonder verlengsnoer, zo neerlegt dat iedereen vrij rond de tafel kan lopen en er niemand over kan struikelen.
- De dampen die tijdens het bereiden van voedsel vrijkomen kunnen gevaarlijk zijn voor (huis)dieren met bijzonder gevoelige luchtwegen, zoals vogels. Wij raden u daarom aan eventuele vogels op een veilige afstand van de plek waar u het apparaat gebruikt te plaatsen.
- Houd het apparaat altijd buiten het bereik van kinderen.
- Controleer of beide zijden van de plaat vóór gebruik goed zijn schoongemaakt.
- Om beschadigingen van de bakplaten te voorkomen dient u deze alleen te gebruiken bij het apparaat waar ze voor bedoeld zijn. (bijv.: niet in een oven plaatsen, op het gas of een elektrische kookplaat...).
- Zorg ervoor dat de platen stabiel zijn, goed geplaatst en vastgeklikt op het apparaat. Gebruik alleen de bij het apparaat geleverde bakplaten of platen aangeschaft via een erkend service center.
- Om beschadigingen aan de bakplaten te voorkomen, adviseren wij u altijd een houten of kunststof spatel te gebruiken.
- Gebruik enkel de accessoires die bij het apparaat werden geleverd of werden gekocht bij een erkend servicenter. Niet gebruiken op andere apparaten.

# Niet doen

- Gebruik het apparaat niet buiten.
- De stekker van het apparaat niet in het stopcontact steken wanneer u het apparaat niet gebruikt.
- Om oververhitting van het apparaat te voorkomen, dient u dit niet in een hoek of tegen een muur te plaatsen.
- Plaats het apparaat nooit rechtstreeks op een kwetsbare ondergrond (glazen tafel, tafelkleed, gelakt meubel...) of op een onstabiele ondergrond, zoals tafelkleden met een verende vulling.
- Plaats het apparaat niet onder een aan de muur bevestigd meubel of wandmeubel of in de nabijheid van andere brandbare materialen zoals (rol)gordijnen, behang, enz.
- Plaats het apparaat niet op of in de buurt van gladde of warme oppervlakken en laat het snoer nooit boven een warmtebron hangen (kookplaat, gasfornuis, enzovoort).
- Plaats geen kookgerei op de kookoppervlakken van het apparaat.
- Snijd het voedsel niet op de platen.
- Gebruik om beschadiging van het bakoppervlak te voorkomen nooit een metalen spons of schuurpoeder.
- Het apparaat niet verplaatsen als het aanstaat.
- Het apparaat niet bij de handgreep of de metalen draden dragen.
- Het apparaat niet gebruiken als het leeg is.
- U mag nooit een velletje aluminiumfolie of ander voorwerp tussen de bakplaten en de te bereiden voedingsmiddelen leggen.
- De vetopvangbak niet vastnemen wanneer het apparaat nog warm is. Als de vetopvangbak tijdens het bakken vol loopt, het apparaat af laten koelen, voordat u het leegt.
- De hete bakplaat niet onder water houden of op een kwetsbare ondergrond plaatsen.
- Om de anti-aanbaklaag te beschermen, dient u te voorkomen dat het apparaat te lang leeg verwarmt.
- U mag de grillplaten nooit hanteren wanneer deze heet zijn.
- Gebruik geen aluminiumfolie om uw ingrediënten in te bakken.
- Geen geflambeerde gerechten bereiden met dit apparaat om beschadiging van uw product te voorkomen.
- Plaats nooit aluminiumfolie of enig ander voorwerp tussen de platen en de weerstanden.
- Laat het apparaat tijdens het opwarmen of bakken nooit in de stand 'grill open' staan.
- Laat het apparaat nooit zonder bakplaten opwarmen.

## Informatie

- Wij danken u voor de aankoop van dit apparaat, dat uitsluitend bestemd is voor huishoudelijk gebruik.
- Voor uw veiligheid voldoet dit apparaat aan de toepasselijke normen en regelgevingen (Richtlijnen Laagspanning, Elektromagnetische Compatibiliteit, Materialen in contact met voedingswaren, Milieu...).
- Bij het eerste gebruik kan het apparaat enige geur of rook afgeven.
- Gebruik voor het reinigen van de platen een spons, warm water en wat afwasmiddel.
- De fabrikant behoudt zich het recht voor dit apparaat of onderdelen daarvan in het belang van de gebruiker te allen tijde zonder voorafgaande kennisgeving te wijzigen.
- Alle vaste of vloeibare etenswaren die in contact komen met de bestanddelen waarop het logo  staat, kunnen niet meer geconsumeerd worden.
- Als het voedsel te dik is, verhindert het beveiligingssysteem de inschakeling van het apparaat.
- De weerstand niet schoonmaken. Als de weerstand echt vuil is, kunt u hem nadat hij volledig is afgekoeld, afwrijven met een droge doek.
- Het bedieningspaneel is een delicaat onderdeel. Maak het alleen schoon met een droge en zachte doek. Maak het niet schoon met een vochtige spons om het risico op schade aan de functies te vermijden.

## Milieu



### Wees vriendelijk voor het milieu !



Uw apparaat bevat materialen die geschikt zijn voor hergebruik.



Lever het in bij het milieustation in uw gemeente of bij onze technische dienst.

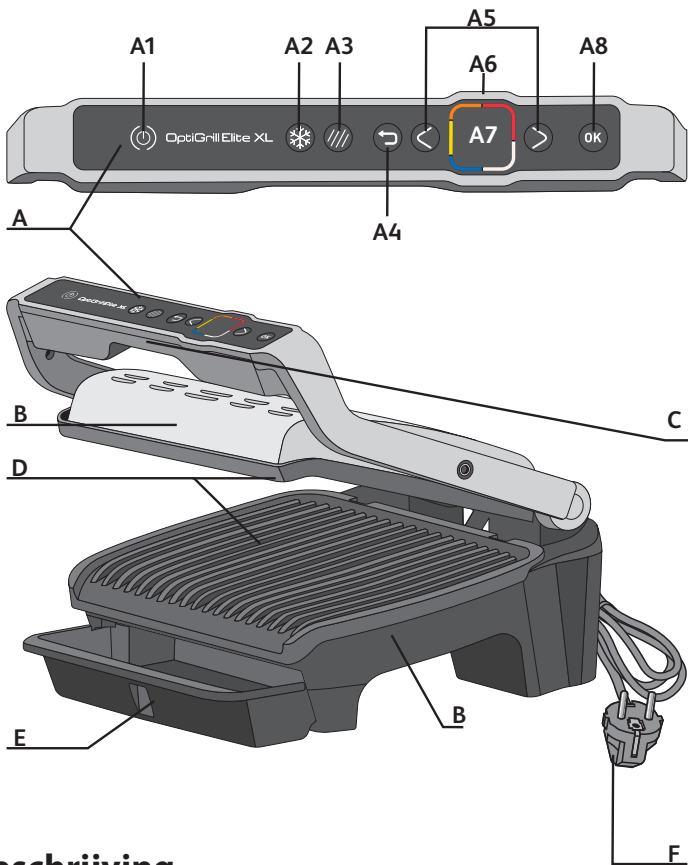

## Beschrijving

**A** Bedieningspaneel

**A1** Aan/uit-knop

**A2** Bevroren ingrediënten-functie

**A3** Dichtschroei-functie

**A4** Terug-knop

**A5** Bedienings- en navigatietoetsen

**A6** Voorverwarmings- en bakkniveau-indicator

**A7** Weergavescherm

**A8** OK knop

**B** Behuizing

**C** Handvat

**D** Grillplaten

**E** Vetopvangbak

**F** Snoer

De knoppen zijn alleen actief als ze verlicht zijn.

# 16 automatische bakprogramma's

NL

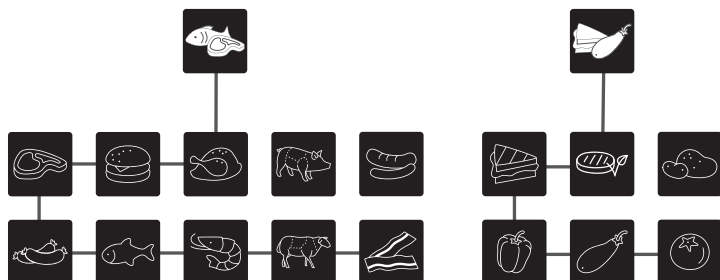

## Twee mogelijke bakopties in de automatische modus



Bevroren ingrediënten-functie



Dichtschroei functie

## Een handmatige modus

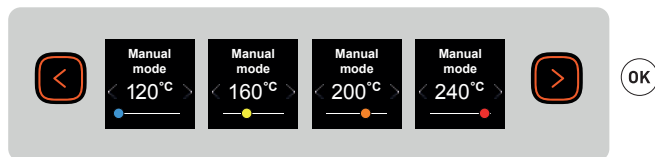

## Een Terug-knop



Als u een submenu hebt geselecteerd en naar het hoofdmenu wilt terugkeren, drukt u één keer op de Terug-knop.

Druk twee keer op de Terug-knop om een verkeerd gekozen programma te annuleren.

# 1 Voorbereiding

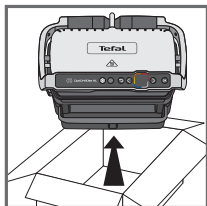
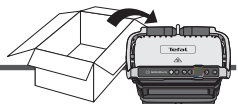

1

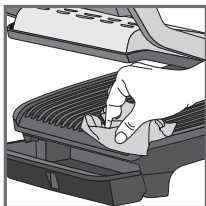

2

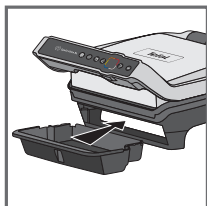

3

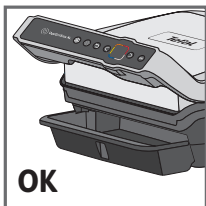

OK

4

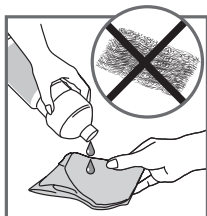

5

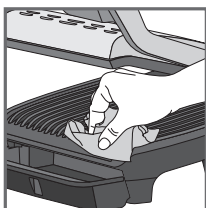

6

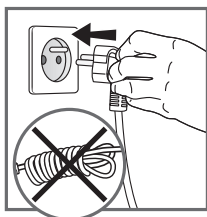

7

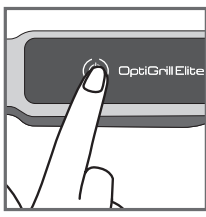

8

1 Verwijder alle verpakkingsmateriaal, stickers en toebehoren aan de binnen- en buitenkant van het apparaat.

2 Voor ingebruikname, maak de grillplaten altijd schoon met warm water en afwasmiddel, spoel en veeg vervolgens grondig droog.

3-4 Installeer de uitneembare vetopvangbak aan de voorkant van het apparaat.

5 Indien gewenst, voor het beste resultaat en een betere doeltreffendheid van de anti-aanbaklaag, smeer de grillplaten met een beetje spijsoolie met behulp van een vel keukenpapier.

6 Verwijder het teveel aan olie met behulp van een schoon vel keukenpapier.

7 Zorg dat de bovenste en onderste platen correct in het product zijn aangebracht. Verwarm het apparaat niet zonder platen voor. Steek de stekker in het stopcontact. (Zorg dat het snoer volledig is afgerold).

8 Druk op de Aan/Uit-knop.

**Opgelet:** Zorg dat er geen voedsel tussen de platen bevindt.

## 2 Ingebruikname

9 Kies uw taal met behulp van de pijlen en druk op ok.

NL



9

## 3 Aan/uit

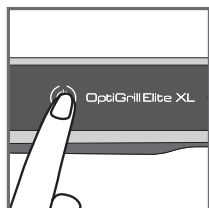

10

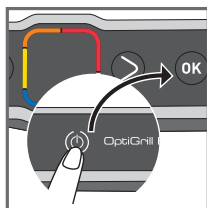

11

10 Schakel de grill in

11 Om de grill uit te schakelen, druk één keer op de aan/uit-knop en één keer op de OK-knop om het uitschakelen van het apparaat te bevestigen.



## 4 Bevroren ingrediënten-functie - in automatische modus



N

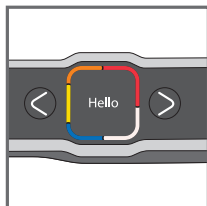

Hallo

12



13

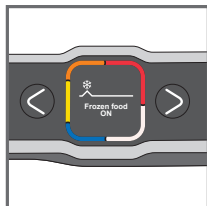

Bevroren ingrediënten  
aan

14

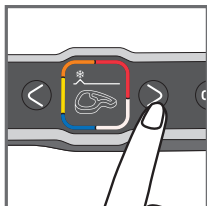

15

**13-15** De Bevroren ingrediënten-functie is tijdens het selecteren van de automatische modus te activeren voor het starten van het voorverwarmingsproces, als het te bakken ingrediënt bevroren/ingevroren is.

Als u vergeten bent deze optie te activeren, drukt u op de Terug-knop en voert u de stappen opnieuw uit.

Deze functie is alleen beschikbaar in de automatische modus, en niet in de handmatige modus.



## 5 Intensieve bakstrepen-functie - in de automatische modus

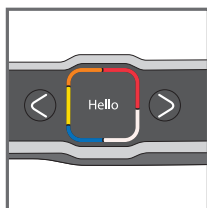

Hallo

16

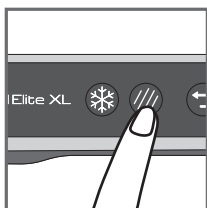

17

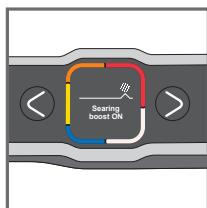

Dichtschroeien aan

18

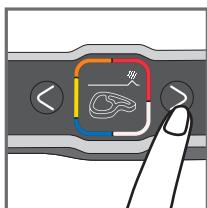

19

**17-19** De Dichtschroei functie is tijdens het selecteren van de automatische modus te activeren voor het starten van het voorverwarmingsproces, als u duidelijke bakstrepen op uw te bakken ingrediënt wilt.

Als u vergeten bent deze optie te activeren, schakel het apparaat uit en voer de stappen opnieuw uit.

Deze functie is alleen beschikbaar in de automatische modus, en niet in de handmatige modus.

## 6 Automatische bakmodus

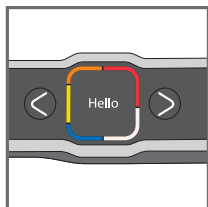

Hallo  
20

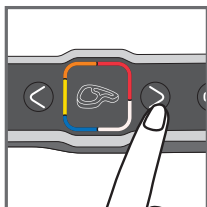

21

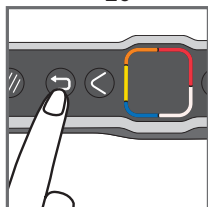

22

In geval u twijfelt over welke bakmodus te gebruiken, raadpleeg de baggidsen op pagina 45.

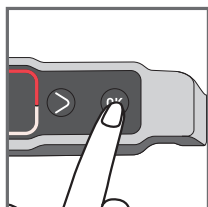

23



Voorverwarmen is bezig

24

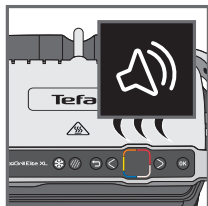

25

- 21 Selecteer de gepaste bakmodus afhankelijk van het soort te bakken ingrediënt.

**Tip, in het bijzonder voor vlees:** het resultaat van de vooraf ingestelde bakprogramma's kan verschillen naargelang de oorsprong, de snijdikte en de kwaliteit van het te bakken voedsel. De programma's werden bepaald en getest met ingrediënten van een hoogwaardige kwaliteit.

Houd tijdens het bakken tevens rekening met de dikte van het vlees. Bak geen vlees dat dikker dan 4 cm is.

- 22 Als u van programma wilt veranderen, kunt u terugkeren naar het hoofdmenu door één keer op de Terug-knop te drukken.

- 23 Druk op de "OK" knop: het apparaat wordt voorverwarmd.

**Let op:** als u per ongeluk het verkeerde programma selecteert, drukt u op de Terug-knop.

- 24 Wacht 4 tot 7 minuten. Wilt u het programma wijzigen terwijl het apparaat al wordt voorverwarmd? Druk op de Terug-knop en bevestig uw keuze met de OK-knop om terug te keren naar het hoofdmenu. Het programma wordt geannuleerd als u twee keer op de knop drukt.

- 25 U hoort een geluidssignaal zodra het voorverwarmen is beëindigd.

**Opmerking:** als het apparaat te lang dicht blijft wanneer het is voorverwarmd, zal het beveiligingssysteem het apparaat automatisch uitschakelen.

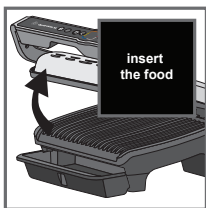

Plaats uw ingrediënten

26

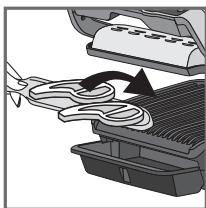

27



28

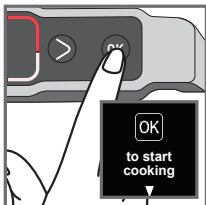

Om het grillproces te starten

29



Start van de bereiding

30



Start van de bereiding

31

26-27

Zodra het voorverwarmen is beëindigd, breng uw ingrediënten aan. Breng de deksel van de grill omhoog en doe de ingrediënten in de grill.

Opmerking: als het apparaat te lang open blijft, zal het beveiligingssysteem het apparaat automatisch uitschakelen.

28-30

Het apparaat berekent automatisch de bakcyclus (tijd en temperatuur) afhankelijk van de hoeveelheid en de dikte van het te bakken ingrediënt. Sluit het apparaat en de bakcyclus start.

**Opmerking voor zeer fijn voedsel, zoals spek:** De „OK“ knop brandt. Druk op „OK“ om ervoor te zorgen dat het apparaat het ingrediënt herkent en de bakcyclus wordt gestart.

De pijl verplaatst zich langs de bakniveau-indicator en wanneer een bakniveau wordt bereikt, wordt het niveau weergegeven en hoort u een geluidssignaal.

Opmerking: de bakniveaus zijn voorgeprogrammeerd voor elke automatische modus.

Tijdens het bakproces hoort u telkens een geluidssignaal wanneer er een bakniveau wordt bereikt (bijv. kort gebakken/geel).

Afhankelijk van de bakgraad verandert de indicator van kleur en verplaatst de pijl voor de voortgang van het bakproces zich over het scherm.

Opmerking, in het bijzonder voor vlees: het is normaal als de bakresultaten verschillen afhankelijk van het soort, de kwaliteit en de oorsprong van het voedsel.



NL



32



Well-done in 01:35

33

**32-33** U kunt op elk moment de resterende baktijd voor het bereiken van de verschillende bakniveaus te weten komen. Druk op de rechter knop om te zien hoe lang het nog duurt voordat het volgend bakniveau wordt bereikt. Opgelet, het betreft hier niet het selecteren van de bakniveaus. De grill blijft bakken tot aan het laatste bakniveau en geeft een waarschuwing bij elk niveau.

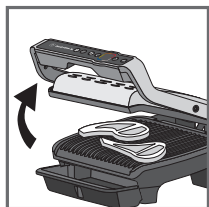

34

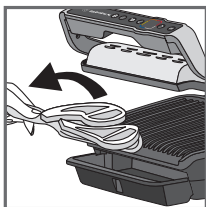

35

**34-35** Wanneer het bakniveau overeenstemt met uw weergegeven keuze en u hoort het geluidssignaal, open het apparaat en verwijder het ingrediënt.

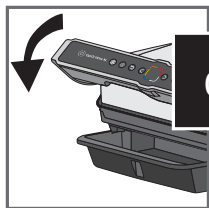

36



Om het kookproces te stoppen

37

**36-37** Breng de deksel omlaag. Het scherm vraagt om uw bevestiging om het bakproces te stoppen. Bevestig met OK wanneer alle ingrediënten zijn verwijderd of bak verder.

Als u een nieuw bakproces wilt starten, raadpleeg sectie 7.

**Opmerking:** het beveiligingssysteem schakelt het apparaat automatisch uit als er na een bepaalde periode geen enkel programma is geselecteerd.

## 7 Een tweede bakproces uitvoeren

### Tweede bakproces van hetzelfde ingrediënt

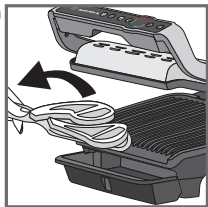

38



Bijvullen?

39

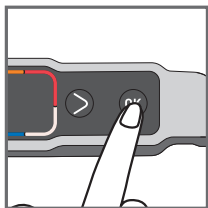

40



Voorverwarmen is bezig

41

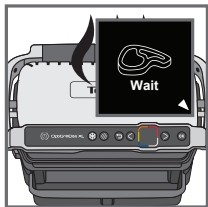

Een ogenblik geduld

42

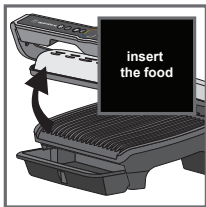

Plaats uw etenswaren

43

**38-39** Aan het einde van het eerste bakproces geeft het scherm „nieuw bakproces“ weer. Als u hetzelfde soort ingrediënt wilt grillen, druk op OK.

**40** Het apparaat start met voorverwarmen.

**41** Wacht tot aan het einde van het voorverwarmingsproces.

**42** Doe het ingrediënt in de grill.

**43** Voer vervolgens stap 27 tot 37 uit.

### Tweede bakproces van een verschillend ingrediënt

Na het beëindigen van het bakproces van uw eerste ingrediënten:

1. Zorg dat het apparaat dicht is en er zich geen ingrediënten in bevinden.
2. Selecteer de gepaste bakmodus.
3. Druk op de "OK" knop om het apparaat voor te verwarmen. Tijdens het voorverwarmen wordt de voorverwarmingsindicator op het scherm weergegeven.

- Na het beëindigen van het voorverwarmen hoort u een geluidssignaal en wordt er informatie over dit einde op het scherm weergegeven.
- Het apparaat is klaar voor gebruik wanneer het voorverwarmen is beëindigd. Breng de deksel van de grill omhoog en doe de ingrediënten in het apparaat. Voer vervolgens stap 27 tot 37 uit.

### Belangrijk:

– Het apparaat voorverwarmen is voor elk bakproces nodig.

Herinnering: Voor het starten van het voorverwarmingsproces, zorg dat het apparaat dicht is en er zich geen ingrediënt in bevindt.

– Wacht totdat het voorverwarmen is beëindigd voordat u de grill opent en er ingrediënten in doet.

**Opmerking:** als er onmiddellijk na een bakproces een nieuw voorverwarmingsproces wordt gestart, zal de voorverwarmingstijd nu korter zijn

## 8 Bakproces in handmatige modus

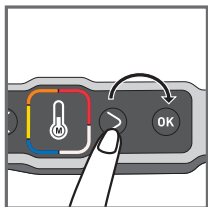

44

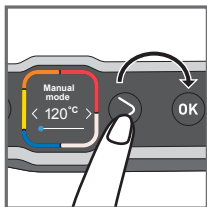

45

44 Selecteer de handmatige modus en druk op OK om te bevestigen.

45 Selecteer de gewenste temperatuur met behulp van de bedieningstoetsen.

Druk op OK om de gekozen temperatuur te bevestigen.

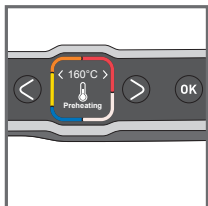

46

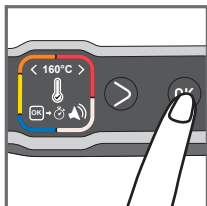

47

46 Wacht tot aan het einde van het voorverwarmingsproces

47 Na het beëindigen van het voorverwarmingsproces, druk op OK om de timer te starten.

**Opmerking:** de baktijd kan tevens worden ingesteld aan het begin van het voorverwarmingsproces.

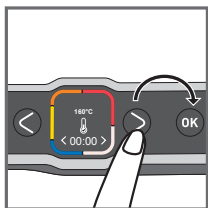

48

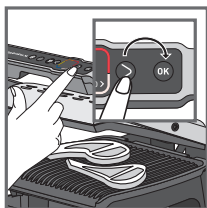

49

48 Druk op de bedieningstoetsen om de gewenste baktijd te selecteren.

49 Plaats de ingrediënten op de grillplaten van het apparaat en druk op OK om het bakproces te starten

Druk op OK om de temperatuur en/of de tijd in te stellen.

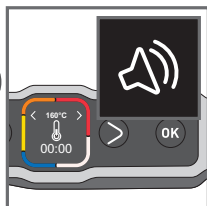

50

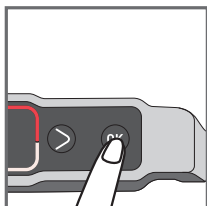

Om het kookproces te stoppen

51

**50-51** Aan het einde van het bakproces hoort u een geluidssignaal. Verwijder het ingrediënt.

Druk op OK om het geluidssignaal te dempen en de ingrediënten te verwijderen.

## 9 Opmerkingen

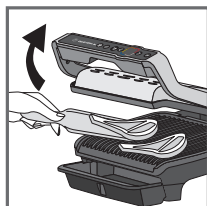

52

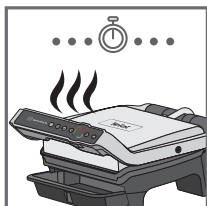

53

**52-54**

Naargelang uw persoonlijke voorkeur, open de grill, verwijder het ingrediënt dat uw gewenste bakniveau heeft bereikt en sluit de deksel om het bakproces voor achterblijvend e ingrediënten voort te zetten. Het programma hervat de bakcyclus tot aan het laatste gekozen bakniveau.



Verwijder uw ingrediënten

54



Risico op te gaar

55

**55** Opmerking: het beveiligingssysteem schakelt het apparaat automatisch uit na een bepaalde periode.



## 10 Na gebruik

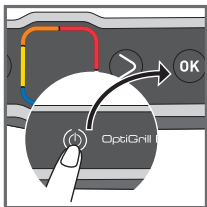

56

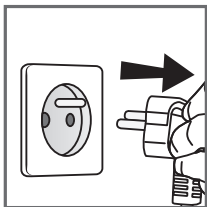

57

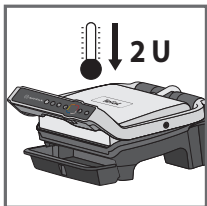

58

56 Druk op de aan/uit-knop en vervolgens op de OK-knop om te bevestigen.

57 Haal de stekker uit het stopcontact.

58 Laat het apparaat minstens 2 uur afkoelen.

Om brandwonden te vermijden, laat de grill volledig afkoelen voordat u het schoonmaakt.

## 11 Reiniging

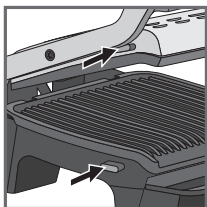

59

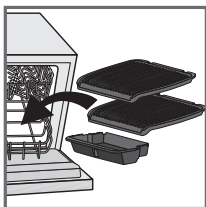

60

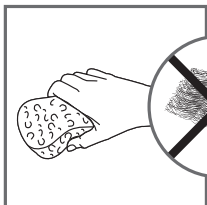

61

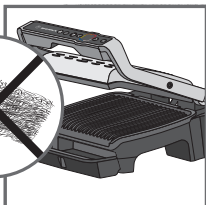

62

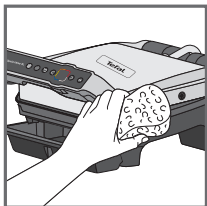

63

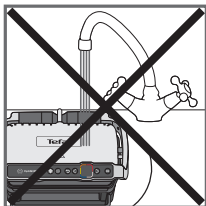

64

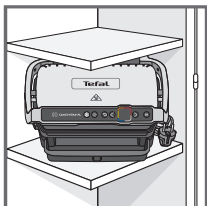

65

**59** Maak de platen los en verwijder ze voordat u ze schoonmaakt om het bakoppervlak niet te beschadigen.

**60** De vetopvangbak en de grillplaten zijn vaatwasmachinebestendig. Stop het apparaat en het snoer nooit in de vaatwasmachine. De verwarmingselementen dienen na het verwijderen van de grillplaten nooit te worden schoongemaakt. Als ze echter zeer vuil zijn, wacht totdat het apparaat volledig is afgekoeld en maak ze dan schoon met een droge doek.

**61-62** De platen zijn eenvoudig te reinigen. Laat ze gedurende een uur in warm water met afwasmiddel weken en spoel ze daarna af om resten te verwijderen. Veeg grondig droog met een vel keukenpapier.

Maak geen enkel onderdeel van de grill schoon met een metalen schuursponsje, staalwol of een agressief schoonmaakmiddel. Gebruik alleen een nylon of niet-metalen schoonmaakpons.

Leeg de vetopvangbak, was het in een warm sopje en veeg grondig droog met een vel keukenpapier.

**63** Maak de deksel van de grill schoon met een spons gedompeld in warm water en veeg droog met een zachte en droge doek. Om het bedieningspaneel schoon te maken, gebruik alleen een zachte en droge doek.

**64** Dompel de behuizing van de grill niet in water of een andere vloeistof.



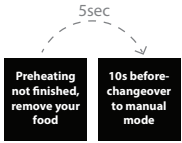

**65** Zorg dat de grill altijd schoon, koud en droog is voordat u het opbergt. Elke andere reparatie moet door een erkende reparateur worden uitgevoerd.

# Probleemoplossing

## PROBLEEMOPLOSSING ELITE





















Probleem	Oorzaak	Oplossing
De taal is gewijzigd		Steek de stekker in het stopcontact, druk op ON en vervolgens onmiddellijk op de Bevroren ingrediënten toets (terwijl „Goedendag“ op het scherm wordt weergegeven)
 <p>5sec</p> <p>Preheating not finished, remove your food</p> <p>10s before changeover to manual mode</p>	De voorverwarmingstijd is niet helemaal voltooid. De grill werd geopend en het ingrediënt werd voor het einde van het voorverwarmingsproces op de plaat gelegd.	<p>Het is mogelijk om het ingrediënt te bakken, maar u dient het bakproces zelf te controleren aangezien de grill in de handmatige modus staat.</p> <p>De temperatuur kan worden aangepast.</p> <p>Of</p> <p>Open de grill, verwijder het ingrediënt, sluit de grill op een juiste manier en wacht totdat het voorverwarmingsproces is voltooid.</p>
Ik kan mijn apparaat niet uitschakelen	Er werd geen tweede keer gedrukt of te veel tijd tussen de 2 drukken.	Druk één keer op de aan/uit-knop en dan op OK om te bevestigen
Fout 1 tot Fout 8	Het apparaat werd in een te koude ruimte opgeborgen of gebruikt. Het apparaat is oververhit.	Haal de stekker uit het stopcontact en wacht enkele minuten. Steek de stekker opnieuw in het stopcontact en druk op On (aan). Als het probleem opnieuw optreedt, neem contact op met een erkend servicecentrum.
Fout 9 tot Fout 13	Storing op het apparaat.	Haal de stekker uit het stopcontact en neem contact op met een erkend servicecentrum.
Het apparaat stopt uit zichzelf tijdens het voorverwarmings- of bakproces.	Het apparaat werd tijdens het bakproces te lang open gehouden. Het apparaat werd na het einde van het voorverwarmings- of warmhoudproces te lang niet gebruikt.	Haal de stekker uit het stopcontact en wacht enkele minuten. Steek de stekker vervolgens opnieuw in het stopcontact en schakel het apparaat in.

## PROBLEEMOPLOSSING ELITE



Probleem	Oorzaak	Oplossing
	Vraag tot bevestiging aan einde van bakproces	2 oplossingen: Druk op OK als al het voedsel is verwijderd Of Druk niet op OK en laat bakken als er nog te bakken levensmiddelen op de grill achterblijven
	Ingrediënt is niet gedetecteerd, het is te fijn.	Druk op OK om het bakproces te starten
	Ingrediënt is te dik	2 oplossingen: Druk op OK om het bakproces in de handmatige modus verder te zetten Of Verwijder het ingrediënt en snij het dunner zodat de automatische modus kan worden gebruikt
Ik kan geen tijd in de handmatige modus instellen	De temperatuurregeling blijft op het scherm weergegeven	Druk één keer op OK om naar de tijdregeling te gaan en stel vervolgens in met behulp van de pijlen. Bevestig met OK  

# Bakniveaus voor elk automatisch programma

## 16 AUTOMATISCHE PROGRAMMA'S

AUTOMATISCHE PROGRAMMA'S		BAKNIVEAU-INDICATOR			
MENU'S		 Blue	 Rare	 Medium	 Well-done
	Rundvlees	Rauw van binnen	Kort gebakken	Half doorbakken	Doorbakken
	Kip	-	-	-	Doorbakken
	Worst	-	-	-	Doorbakken
	Spek	-	-	Half doorbakken	Knapperig
	Hamburger	-	Kort gebakken	Half doorbakken	Doorbakken
	Panini	-	Licht gebakken	Geroosterd	Knapperig
	Vis	-	Half doorbakken	Over half doorbakken	Doorbakken
	Vis en schaaldieren	-	Half doorbakken	Over half doorbakken	Doorbakken
	Aardappelen	-	-	-	Sappig
	Paprika	-	-	Krokant	Sappig
	Aubergine	-	-	-	Gegrild
	Tomaat	-	-	Krokant	Sappig
	Varkensvlees	-	-	Over half doorbakken	Doorbakken
	Voorgegaarde worst	-	-	-	Sappig
	Lamsvlees	-	Half doorbakken	Over half doorbakken	Doorbakken
	Vegetarische burger	-	-	-	Sappig

## BAKTIP

PRODUCTEN	BAK-PROGRAMMA	BAK-TIP
Varkenshaas (zonder botten), varkensbuik		Doorbakken *
Bratwurst (voorgekookt varkensvlees)		220°C / 8 min 30
Rindswurst (voorgekookt rundvlees)		220°C / 8 min 30
Nürnberger Wurst (voorgekookt varkensvlees)		220°C / 4 min 30

## SPECIALE HANDMATIGE MODUS

### GROENTE OF FRUIT

From 180°C to 195°C	From 220°C to 235°C	From 225°C to 270°C
-	-	Courgette (schijfjes)
-	-	Asperge
-	-	Champignon
-	Ui	-
Brocoli	-	-
Mini-wortelen	-	-
-	Venkel	-
Zoete aardappel (schijfjes)	-	-
-	Appel (schijfjes)	-
-	Ananas	-
-	Perzik	-

## BEREIDINGSTIP

Voor mooiere bakstrepen op het voedsel, wordt het aanbevolen om het geroosterde voedsel voor het opdienen om te draaien.

PRODUCTEN	BEREIDINGSTIP
AARD-APPELEN	<ul style="list-style-type: none"><li>• Schijfjes in de lengte</li><li>• Voeg olie aan de ingrediënten toe voor een beter bakresultaat</li></ul>
PAPRIKA	<ul style="list-style-type: none"><li>• Snij in de lengte in tweeën</li></ul>
AUBERGINE	<ul style="list-style-type: none"><li>• Schijfjes in de lengte</li><li>• Voeg olie aan de ingrediënten toe voor een beter bakresultaat</li></ul>
TOMAAT	<ul style="list-style-type: none"><li>• Gebruik ronde tomaten</li><li>• Gebruik geen te rijpe tomaten</li><li>• Snij in de breedte in tweeën</li><li>• Voor het beste bakresultaat, leg de ronde kant van de in 2 gesneden tomaat op de onderste grillplaat.</li></ul>
VARKENSVLEES	* Gebruik de dichtschroei functie als de dikte 20 mm overschrijdt.

# WICHTIGE SICHERHEITSHINWEISE

**Benutzung, Wartung, Reinigung und Verwendung des Produktes: Beziehen Sie sich zu Ihrer Sicherheit bitte auf die verschiedenen Abschnitte dieser Bedienungsanleitung und die entsprechenden Symbole.**

Dieses Gerät ist ausschließlich für den Hausgebrauch bestimmt.

Es ist keinesfalls geeignet, in folgenden Fällen verwendet zu werden, die zudem von der Garantie ausgeschlossen sind:

- in Küchenecken für Verkaufs- und Büroangestellte und sonstigen gewerblich genutzten Einrichtungen,
- in landwirtschaftlichen Betrieben,
- in Unterkünften und sonstigen Gastronomie- und Hotelbetrieben für deren Gäste,
- in Pensionen und Privatunterkünften.

Alle Verpackungen, Klebestreifen oder diversen Zubehörteile innen und außen am Gerät entfernen.

Dieses Gerät ist nicht zur Handhabung durch Personen (einschließlich Kindern) mit eingeschränkten körperlichen, sensorischen oder mentalen Fähigkeiten oder durch Personen mit mangelnder Erfahrung bzw. mangelnden Kenntnissen vorgesehen, es sei denn unter Aufsicht einer Person, die für ihre Sicherheit verantwortlich ist und gegebenenfalls vorab Anweisungen zur Handhabung des Geräts gegeben hat. Kinder müssen beaufsichtigt werden, um sicherzustellen, dass sie nicht mit dem Gerät spielen.

Kinder müssen beaufsichtigt werden, um sicherzustellen, dass sie nicht mit dem Gerät spielen oder das Gerät als Spielzeug verwenden.

Gerät im Betrieb niemals unbeaufsichtigt lassen.

 Frei zugängliche Flächen können im Betrieb hohe Temperaturen erreichen. Achten Sie darauf, nicht mit heißen Geräteteilen in Berührung zu kommen.

Dieses Gerät ist nicht dafür bestimmt, durch einen externen Timer oder ein separates Fernsteuerungssystem in Betrieb genommen zu werden.

Kabel vollständig abrollen.

Um Gefahren zu vermeiden, darf ein schadhaftes Stromkabel nur vom Hersteller, dessen Kundendienst oder einer ähnlich qualifizierten



Person ausgetauscht werden.

Wird ein Verlängerungskabel verwendet, muss es mindestens denselben Querschnitt haben und geerdet sein. Stellen Sie sicher, dass das Kabel niemanden behindert.

Das Gerät nur an einer geerdeten Steckdose anschließen.

Sicherstellen, dass die Elektroinstallation mit der auf der Geräteunterseite angegebenen Leistung und Spannung vereinbar ist.

Gerät oder das Kabel niemals in Wasser tauchen.

Dieses Gerät darf nur dann von Kindern ab 8 Jahren und Personen mit eingeschränkten körperlichen, sensorischen oder geistigen Fähigkeiten oder von Personen mit mangelnder Erfahrung bzw. mangelnden Kenntnissen verwendet werden, wenn sie beaufsichtigt werden oder in die sichere Bedienung des Geräts eingewiesen wurden und die damit verbundenen Gefahren verstehen. Die Reinigung und Pflege darf nicht von Kindern ausgeführt werden, außer wenn sie über 8 Jahre alt sind und beaufsichtigt werden.

Bewahren Sie das Gerät mitsamt Kabel außerhalb der Reichweite von Kindern unter 8 Jahren auf.

**ACHTUNG:** Den Grill nicht ohne die 2 Platten auf- oder vorheizen.

## **Befolgen Sie die nachfolgenden Punkte:**

- Die Hinweise in dieser Anleitung, die je nach dem mit Ihrem Gerät gelieferten Zubehör bei den unterschiedlichen Versionen identisch ausfallen, aufmerksam lesen und in Reichweite aufbewahren.
- Im Falle eines Unfalls sofort kaltes Wasser über die Verbrennung laufen lassen und notfalls einen Arzt rufen.
- Vor der ersten Benutzung die Platten abwaschen (siehe Abschnitt 11), ein wenig Öl darauf verteilen und mit einem weichen Lappen abreiben.
- Bei der Platzierung des Kabels, mit oder ohne Verlängerung, darauf achten und alle Sicherheitsvorkehrungen treffen, dass keine sich am Tisch befindende Person behindert wird, indem sie sich darin beispielsweise verfängt.
- Für Tiere mit einem sensiblen Atmungssystem, wie beispielsweise Vögel, können Grilldämpfe gefährlich sein. Vogelbesitzern wird empfohlen, die Tiere außerhalb der Reichweite des Gerätes zu platzieren.
- Stellen Sie das Gerät immer außerhalb der Reichweite von Kindern auf.
- Stellen Sie sicher, dass die beiden Heizplatten vor der Nutzung gut gereinigt sind.
- Damit die Platten nicht beschädigt werden, verwenden Sie diese ausschließlich mit dem Gerät, für das sie gedacht sind (Verwenden Sie sie beispielsweise nicht in einem Backofen, auf einem Gasherd oder einer Elektrokochplatte...).
- Achten Sie darauf, dass die Platten fest am Gerät angebracht sind. Verwenden Sie ausschließlich die Platten, die vom autorisierten Kundendienst ausgeliefert oder erworben wurden.
- Um die Beschichtung der Platten zu schützen, stets einen Kunststoff- oder Holzwender verwenden.
- Verwenden Sie nur mit dem Gerät geliefertes oder bei einer autorisierten Kundendienststelle gekauftes Zubehör. Nicht mit anderen Geräten zusammen verwenden.

# Beachten Sie, was Sie vermeiden müssen.

- Gerät niemals am Stromkreislauf lassen, wenn es nicht benutzt wird.
- Um eine Überhitzung zu vermeiden, darf das Gerät nicht in Ecken oder an einer Wand platziert werden.
- Ihr Gerät niemals direkt auf eine empfindliche Fläche (Glastisch, Tischdecke, lackiertes Möbelstück...) oder auf eine Plastiktischdecke stellen.
- Ihr Gerät niemals unter ein an der Wand befestigtes Möbelstück oder Regal oder in der Nähe von leicht entflammbarem empfindlichem Material wie Rollos, Vorhänge oder Tapeten stellen. Sollte das Gerät Feuer fangen, nicht mit Wasser löschen. Ziehen Sie den Netzstecker und ersticken Sie die Flammen mit einem feuchten Tuch.
- Ihr Gerät nicht auf oder in der Nähe einer rutschigen oder heißen Oberfläche stellen. Lassen Sie außerdem das Kabel nicht in der Nähe einer Wärmequelle liegen (Heizplatten, Gasherd...) und legen oder ziehen Sie es nicht über scharfe Kanten..
- Keine Kochutensilien auf die Grillflächen des Geräts legen.
- Nicht direkt auf den Heizplatten schneiden.
- Niemals einen Stahlschwamm oder Scheuerpulver verwenden, um die Grillfläche nicht zu beschädigen (Antihafbeschichtung).
- Achten Sie darauf, dass das Gerät bei Gebrauch immer frei steht.
- Das Gerät nicht am Griff oder an den Metalldrähten tragen.
- Gerät niemals leer betreiben. Benutzen Sie das Gerät nicht, wenn es nicht fehlerfrei funktioniert, gefallen ist oder sichtbare Schäden aufweist. Jeder Eingriff, außer der im Haushalt üblichen Reinigung und Wartung durch den Kunden, muss durch einen autorisierten Service Partner erfolgen. Ziehen Sie niemals den Steckeran der Zuleitung aus der Steckdose. Lassen Sie das Gerät vollständig abkühlen, bevor Sie es reinigen und wegräumen. Bewegen Sie das Gerät nicht so lange es heiß ist. Stellen Sie das Thermostat auf die Min.- Position (je nach Modell). Trennen Sie das Gerät nach jeder Benutzung und vor jeder Reinigung vom Stromnetz. Vor der nächsten Benutzung müssen alle Geräteteile trocken sein.
- Niemals Aluminiumfolie oder andere Gegenstände zwischen die Platten und die Speisen legen.
- Während des Garvorgangs die Fettaufangschale nicht herausnehmen. Wenn die Auffangschale während des Garvorgangs voll ist, lassen Sie das Gerät erst abkühlen, bevor Sie sie herausnehmen.
- Die heiße Platte nicht unter Wasser oder auf eine empfindliche Oberfläche legen.
- Für die Erhaltung der Antihafbeschichtung achten Sie darauf, dass das Gerät nicht zu lange leer erwärmt wird.
- Die Platten dürfen niemals in heißem Zustand behandelt werden.
- Niemals mit Folie garen.
- Flambieren Sie niemals Speisen auf dem Gerät, damit dieses nicht beschädigt wird.
- Niemals Aluminiumfolie oder andere Gegenstände zwischen die Platten und die Heizstäbe legen.
- Niemals erhitzen oder Garvorgänge durchführen, wenn sich das Gerät in der Stellung "Grill geöffnet" befindet.
- Das Gerät niemals ohne die Heizplatten erhitzen.

## Hinweise/Informationen

- Vielen Dank, dass Sie sich für den Kauf dieses Gerätes entschieden haben, das ausschließlich für den Hausgebrauch bestimmt ist.
- Zur Gewährleistung Ihrer Sicherheit entspricht das Gerät den geltenden Normen und Bestimmungen (Niederspannungsrichtlinie;
- elektromagnetische Verträglichkeit; Materialien, die mit Lebensmitteln in Berührung kommen; Umwelt...).
- Bei der ersten Inbetriebnahme ist es möglich, dass eine leichte Geruchs- oder Rauchentwicklung entsteht.
- Öffnen Sie in diesem Fall das Fenster, bis keine Rauch oder Geruchsbildung mehr feststellbar ist.
- Verwenden Sie zur Reinigung der Heizplatten einen Schwamm, heißes Wasser und Spülmittel.
- Unsere Gruppe behält sich das Recht vor, im Interesse des Nutzers die Eigenschaften und Einzelteile des Produktes jederzeit zu bearbeiten.
- Jedes flüssige oder feste Lebensmittel, das mit den mit dem Logo  gekennzeichneten Teilen in Berührung kommt, darf nicht verzehrt werden.
- Wenn die Lebensmittel zu dick sind, verhindert das Sicherheitssystem, dass das Gerät in Betrieb genommen wird.
- Das Heizelement darf nicht gereinigt werden. Sollte es sehr verschmutzt sein, warten Sie, bis es vollständig abgekühlt ist und reiben Sie es mit einem trockenen Tuch ab.
- Das Bedienfeld ist sehr empfindlich: nur mit einem trockenen und weichen Tuch, reinigen, abwischen und trocknen. Nicht mit einem feuchten Schwamm reinigen, andernfalls könnte die Funktionsfähigkeit des Bedienfeldes beeinträchtigt werden.

## Umwelt



### Denken Sie an den Schutz der Umwelt!



Ihr Gerät enthält wertvolle Rohstoffe, die wiederverwertet werden können.



Geben Sie Ihr Gerät zur Entsorgung deshalb bitte bei einer Sammelstelle Ihrer Stadt oder Gemeinde ab.

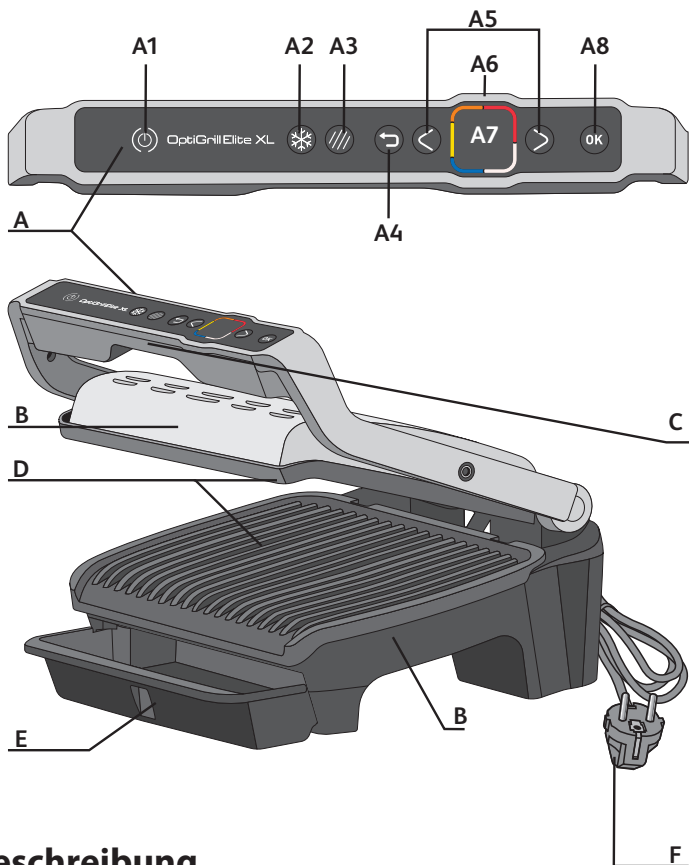

## Beschreibung

- |  |   |                            |
|--|---|----------------------------|
| <b>A</b> Bedienfeld                              | <b>A5</b> Einstell- und Navigationstasten | <b>C</b> Griff             |
| <b>A1</b> Ein-/Aus-Taste                         | <b>A6</b> Vorheiz- und Garstufen-Anzeige  | <b>D</b> Grillplatten      |
| <b>A2</b> Funktion für tiefgekühlte Lebensmittel | <b>A7</b> Display                         | <b>E</b> Saftauffangschale |
| <b>A3</b> Funktion für kräftigere Grillstreifen  | <b>A8</b> OK-Taste                        | <b>F</b> Netzkabel         |
| <b>A4</b> Zurück-Taste                           | <b>B</b> Haupteinheit                     |                            |

Die Tasten sind nur aktiv, wenn sie leuchten.

# 16 automatische Garprogramme

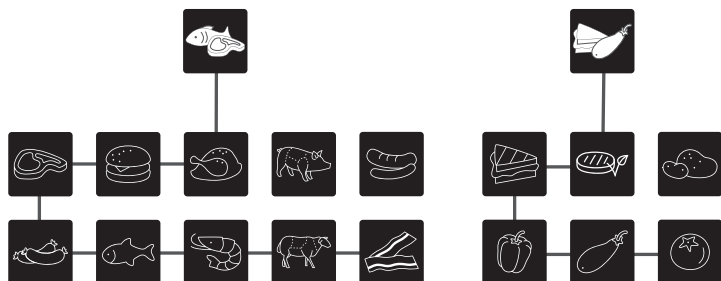

## Im automatischen Modus stehen zwei Optionen zur Verfügung:



Funktion für tiefgekühlte Lebensmittel



Funktion für intensivere Grillstreifen

## Ein manueller Modus

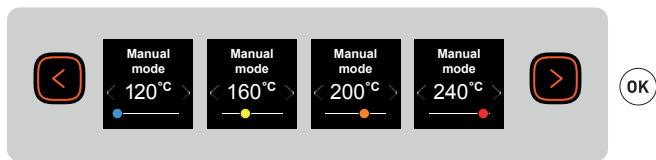

## Eine Zurück-Taste



Wenn Sie in ein Untermenü gegangen sind und zum Hauptmenü zurückkehren möchten, drücken Sie einmal die Zurück-Taste. Wenn Sie das falsche Programm ausgewählt haben, drücken Sie zweimal die Zurück-Taste, um die Funktion abubrechen.

# 1 Vorbereitung

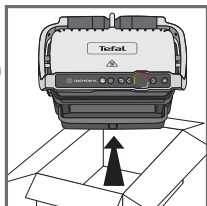
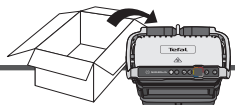

1

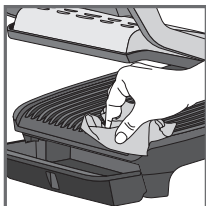

2

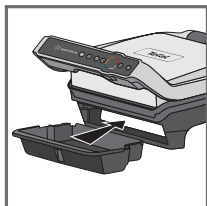

3



4

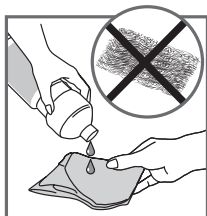

5

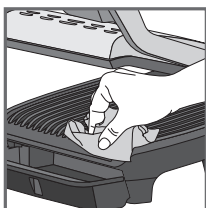

6

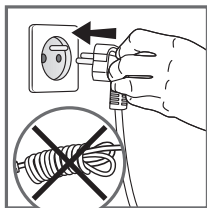

7

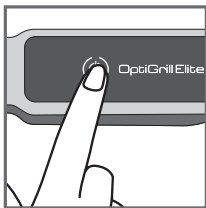

8

1 Entfernen Sie sämtliches Verpackungsmaterial, Aufkleber und Zubehörteile im Inneren und an den Außenflächen des Geräts.

2 Reinigen Sie vor dem ersten Gebrauch die Platten sorgfältig mit heißem Wasser und Geschirrspülmittel, spülen und trocknen Sie die Platten anschließend gründlich ab.

3-4 Befestigen Sie die herausnehmbare Saftauffangschale an der Vorderseite des Gerätes.

5 Um bessere Ergebnisse zu erzielen und die Wirkung der antihafbeschichteten Oberfläche zu optimieren, können Sie mithilfe eines Küchenpapiers die Grillplatten mit etwas Öl einfetten.

6 Entfernen Sie überschüssiges Öl mit einem sauberen Küchenpapier.

7 Vergewissern Sie sich, ob die oberen und unteren Platten korrekt im Produkt eingesetzt wurden. Heizen Sie das Gerät nicht ohne Platten auf. Schließen Sie das Gerät an eine Steckdose an. (Achten Sie darauf, dass das Kabel vollständig abgewickelt ist.)

8 Drücken Sie die Ein/Aus-Taste.

Achtung: Vergewissern Sie sich, dass sich keine Lebensmittel zwischen den Platten befinden.

## 2 Erster Gebrauch

9 Wählen Sie mithilfe der Pfeile Ihre Sprache und drücken Sie dann OK.



9

## 3 Ein-/Aus-Taste



10

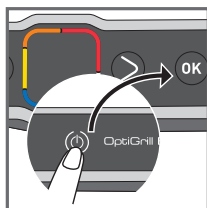

11

10 Schalten Sie das Gerät ein.

11 Drücken Sie zum Ausschalten des Gerätes einmal auf die Ein-/Aus-Taste und einmal auf OK, um das Ausschalten des Gerätes zu bestätigen.

## 4 Funktion für tiefgekühlte Lebensmittel - im automatischen Modus

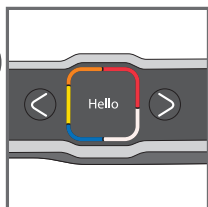

Hallo

12



(13-15)

Die Funktion für tiefgekühlte Lebensmittel ist vor dem Starten des Vorheizvorgangs zu aktivieren. Wählen Sie bei der Auswahl des automatischen Modus aus, ob das Grillgut tiefgekühlt/gefroren ist.

Falls Sie vergessen haben, die Funktion zu aktivieren, drücken Sie die Zurück-Taste und wiederholen Sie die Schritte.

Diese Funktion steht nur im automatischen Modus, nicht im manuellen Modus, zur Verfügung.

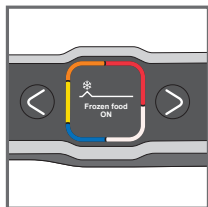

Gefrorene Speisen aus

14

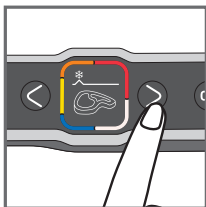

15



## 5 Funktion für intensivere Grillstreifen- im automatischen Modus

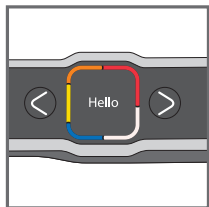

Hallo

16

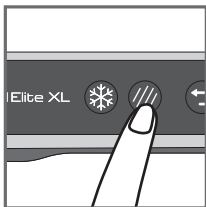

17

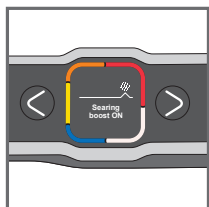

Scharfes Anbraten ein

18

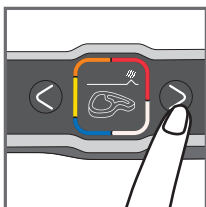

19

**17-19** Die Funktion für intensivere Grillstreifen ist vor dem Starten des Vorheizvorgangs zu aktivieren. Wählen Sie die Funktion bei der Auswahl des automatischen Modus aus, wenn Sie ausgeprägtere Grillstreifen auf dem Grillgut wünschen.

Falls Sie vergessen haben, die Funktion zu aktivieren, schalten Sie das Gerät aus und wiederholen Sie die Schritte.

Diese Funktion steht nur im automatischen Modus, nicht im manuellen Modus, zur Verfügung.

DE

## 6 Garen im automatischen Modus

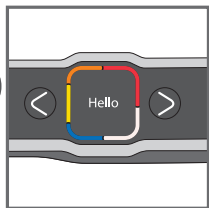

Hallo  
20

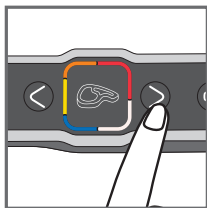

21

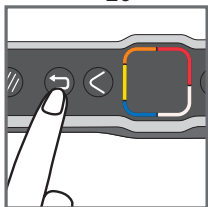

22

Wenn Sie sich nicht sicher sind, welchen Garmodus Sie verwenden sollten, ziehen Sie den Garleitfaden auf Seite 67 zurate.

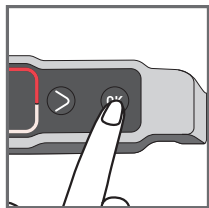

23



Wird vorgeheizt

24

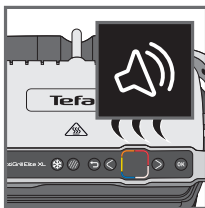

25

- 21 Wählen Sie den für die Art des Grillguts geeigneten Garmodus.

**Tipp, insbesondere für Fleisch:** Die Garergebnisse der voreingestellten Programme können je nach Herkunft, Zuschnitt und Qualität des Grillguts variieren. Die Programme wurden mit Lebensmitteln von guter Qualität eingestellt und getestet.

Ebenso muss die Dicke des Fleisches beim Garen berücksichtigt werden. Garen Sie keine Lebensmittel, die dicker als 4 cm sind.

- 22 Wenn Sie das Programm wechseln möchten, können Sie durch einmaliges Drücken der Zurück-Taste zum Hauptmenü zurückkehren.

- 23 Drücken Sie die Taste „OK“: Das Gerät beginnt, vorzuheizen.

**Hinweis:** Wenn Sie versehentlich ein Programm auswählen, drücken Sie die Zurück-Taste.

- 24 Warten Sie 4 bis 7 Minuten. Wenn Sie das gewählte Programm ändern möchten, drücken Sie nach dem Start der Aufwärmzeit die Zurück-Taste und bestätigen Sie mit der OK-Taste, um zum Hauptmenü zurückzukehren. Ein zweites Drücken der Zurück-Taste bricht den Vorgang ab.

- 25 Ein akustisches Signal zeigt an, wenn das Vorheizen abgeschlossen ist.

**Anmerkung:** Wenn das Gerät nach Abschluss des Vorheizvorgangs zu lange geschlossen bleibt, schaltet das Sicherheitssystem das Gerät aus.

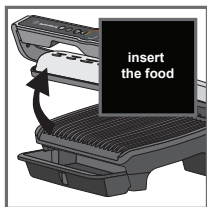

Speisen einlegen

26

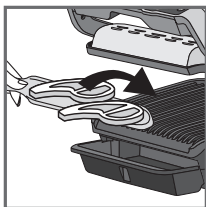

27

(26-27)

Sobald der Vorheizvorgang abgeschlossen ist, können Sie Ihre Zutaten in den Grill legen. Öffnen Sie den Deckel des Grills und legen Sie die Lebensmittel auf den Grill.

Anmerkung: Wenn das Gerät zu lange geöffnet ist, schaltet das Sicherheitssystem das Gerät automatisch aus.



28

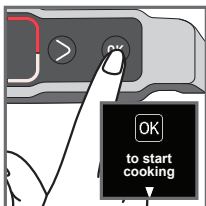

Garvorgang starten

29

28-30

Das Gerät berechnet automatisch nach Menge und Dicke der Lebensmittel den Garzyklus (Garzeit und Temperatur).

Schließen Sie den Deckel des Gerätes, damit der Garvorgang beginnen kann.

**Hinweis zu sehr dünnen Lebensmitteln, zum Beispiel Bacon:** Die OK-Taste leuchtet auf. Drücken Sie dann auf OK, um sicherzustellen, dass das Gerät die Lebensmittel erkennt und der Garzyklus beginnt.

Die OK-Taste leuchtet auf. Drücken Sie dann auf OK, um sicherzustellen, dass das Gerät die Lebensmittel erkennt und der Garzyklus beginnt.



Garvorgang beginnt

30



31

Der Pfeil bewegt sich entlang der Garstufen-Anzeige und wenn das Gerät eine Garstufe erreicht, wird die Stufe angezeigt und das Gerät erzeugt ein akustisches Signal.

Anmerkung: Die Garstufen sind für jedes automatische Programm voreingestellt.

Während des Garvorgangs benachrichtigt ein akustisches Signal den Benutzer jedes Mal, wenn eine Garstufe erreicht ist (z. B. blutig).

Die Anzeige ändert je nach Garstufe die Farbe und der Pfeil bewegt sich entsprechend des Garfortschritts entlang des Displays.

Beachten Sie bitte, dass es besonders bei Fleisch normal ist, wenn die Garergebnisse je nach Fleischsorte, Qualität und Herkunft der Nahrung variieren.



32



33

Durchgebraten in 01:35

**32-33** Sie können sich jederzeit über die verbleibende Zeit zum Erreichen der verschiedenen Garstufen informieren. Drücken Sie auf den Rechts-Pfeil, wenn Sie sehen möchten, wie lange es dauern wird, bis die nächste Garstufe erreicht ist. Achtung - Es handelt sich dabei nicht um die Auswahl einer Garstufe. Der Grill fährt fort, bis zur letzten Garstufe zu garen, und benachrichtigt den Benutzer bei jeder Garstufe.

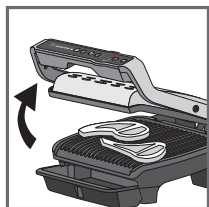

34

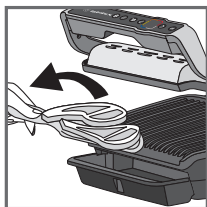

35

**34-35** Wenn die Garstufe Ihrer Wahl angezeigt wird und das akustische Signal ertönt, öffnen Sie das Gerät und entnehmen Sie Ihre Speisen.

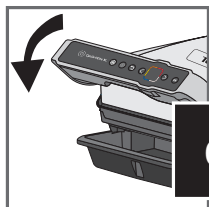

36



37

Garvorgang beenden

**36-37** Schließen Sie den Deckel. Das Display fordert Sie auf, den Abbruch des Garvorgangs zu bestätigen. Bestätigen Sie mithilfe von OK, dass alle Lebensmittel vom Grill genommen wurden, sonst wird der Garvorgang fortgesetzt.

Wenn Sie einen neuen Garvorgang starten möchten, lesen Sie bitte Abschnitt 7.

**Anmerkung:** Das Sicherheitssystem schaltet das Gerät automatisch aus, wenn nach einer gewissen Zeit kein Programm ausgewählt wurde.

## 7 Durchführen eines zweiten Garvorgangs

### Zweiter Garvorgang mit der gleichen Art Grillgut

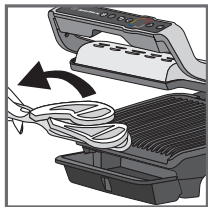

38



Nachlegen?

39

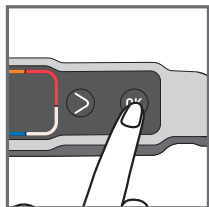

40



Wird vorgeheizt

41

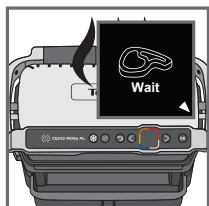

Warten

42

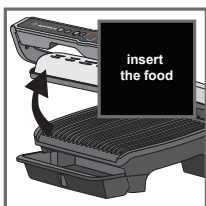

Speisen einlegen

43

**38-39** Nach Ablauf des ersten Garvorgangs wird auf dem Display „nouvelle cuisson“ (neuer Garvorgang) angezeigt. Wenn Sie die gleiche Art von Grillgut grillen möchten, drücken Sie OK.

**40** Das Gerät beginnt vorzuheizen.

**41** Warten Sie bis zum Ende des Vorheizvorgangs.

**42** Legen Sie das Grillgut in den Grill.

**43** Folgen Sie dann den Schritten 27 bis 37.

### Zweiter Garvorgang mit einer anderen Art Grillgut

Sobald der Garvorgang für Ihre ersten Speisen abgeschlossen ist:

1. Vergewissern Sie sich, dass das Gerät geschlossen ist und sich kein Grillgut zwischen den Platten befindet.
2. Wählen Sie den passenden Modus oder das passende Garprogramm.
3. Drücken Sie „OK“, um den Vorheizvorgang zu beenden. Während des Vorheizens erscheint die Vorheiz-Anzeige auf dem Display.

4. Sobald der Vorheizvorgang beendet ist, ertönt ein akustisches Signal und auf dem Display wird das Ende des Vorheizvorgangs angezeigt.
5. Nach dem Vorheizen ist das Gerät einsatzbereit. Öffnen Sie den Deckel des Grills und legen Sie die Lebensmittel in den Grill. Folgen Sie dann den Schritten 27 bis 37.

### Wichtig:

– Bitte beachten Sie, dass das Vorheizen für jeden Garvorgang obligatorisch ist.

Denken Sie daran: Stellen Sie vor dem Starten des Vorheizvorgangs sicher, dass das Gerät geschlossen ist und das sich kein Grillgut im Grill befindet.

– Warten Sie dann, bis das Vorheizen abgeschlossen ist, bevor Sie den Grill öffnen und die Lebensmittel in den Grill legen.

**Anmerkung:** Wenn der neue Vorheizzyklus sofort nach dem Ende des vorherigen Zyklus gestartet wird, ist der Vorheizvorgang kürzer.

## 8 Garen im manuellen Modus

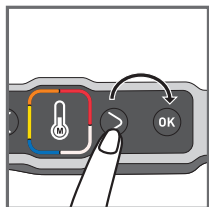

44

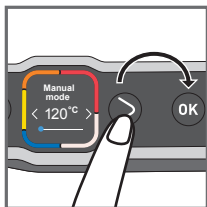

45

44 Wählen Sie den manuellen Modus und drücken Sie zur Bestätigung OK.

45 Wählen Sie die gewünschte Temperatur mithilfe der Einstelltasten. Drücken Sie zur Bestätigung der ausgewählten Temperatur OK.

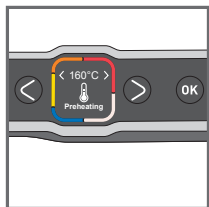

46

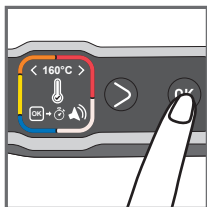

47

46 Warten Sie bis zum Ende des Vorheizvorgangs.

47 Sobald das Vorheizen beendet ist, drücken Sie OK, um den Timer zu starten.

**Anmerkung:** Die Garzeit kann auch zu Beginn des Vorheizvorgangs eingestellt werden.

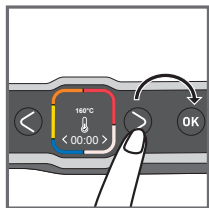

48

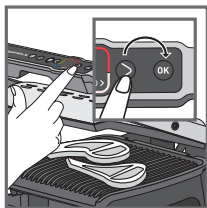

49

48 Drücken Sie die Einstelltasten, um die gewünschte Garzeit auszuwählen.

49 Legen Sie Ihr Grillgut in den Grill und drücken Sie OK, um den Garvorgang und den Timer zu starten.

Drücken Sie jederzeit die OK-Taste, um die Temperatur und/oder die Zeit einzustellen.

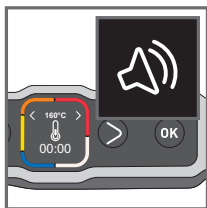

50

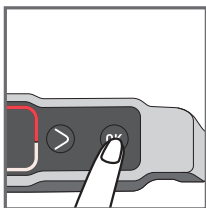

Garvorgang beenden

51

**50-51** Ein akustisches Signal zeigt Ihnen an, wenn die Garzeit abgelaufen ist. Entnehmen Sie Ihre Speisen.

Drücken Sie OK, um den Signalton zu beenden und Ihre Speisen zu entnehmen.

DE

## 9 Anmerkungen

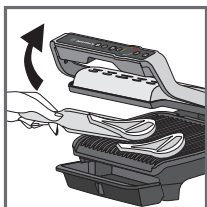

52

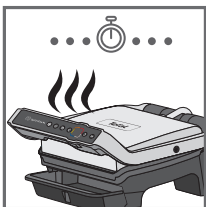

53

**52-54**

Öffnen Sie je nach persönlicher Vorliebe den Grill und entnehmen Sie die Speisen, die die gewünschte Garstufe erreicht haben. Schließen Sie den Grill dann wieder, um den Garvorgang für die restlichen Lebensmittel fortzusetzen. Das Programm folgt dem Garzyklus bis zur letzten Garstufe des gewählten Modus.



Speisen entnehmen

54



Evtl. verbraten

55

**55 Anmerkung:** Das Sicherheitssystem schaltet das Gerät automatisch nach einer gewissen Zeit aus.

## 10 Betrieb beenden

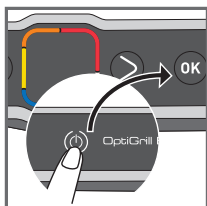

56

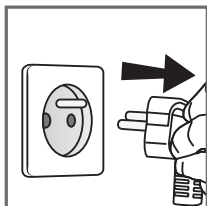

57

**56** Drücken Sie einmal die Ein-/Aus-Taste und dann zur Bestätigung die OK-Taste.

**57** Ziehen Sie den Netzstecker des Geräts.

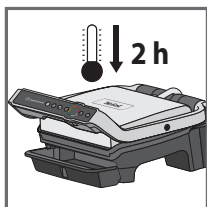

58

**58** Lassen Sie das Gerät mindestens für 2 Stunden abkühlen.

Lassen Sie den Grill vor dem Reinigen vollständig abkühlen, um Verbrennungen zu vermeiden.

## 11 Reinigung

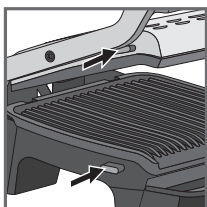

59



60

**59** Lösen und entfernen Sie vor der Reinigung die Platten, um Beschädigungen an der Garfläche zu vermeiden.

**60** Die Saftauffangschale und die Platten können in die Geschirrspülmaschine gestellt werden. Das Gerät und sein Kabel dürfen unter keinen Umständen in der Geschirrspülmaschine gereinigt werden. Die Heizelemente dürfen in keinem Fall gereinigt werden, nachdem die Platten entfernt wurden. Wenn sie sehr verschmutzt sind, warten Sie bis das Gerät vollständig abgekühlt ist, und reinigen Sie die Heizelemente mit einem trockenen Tuch.



# 11 Reinigung

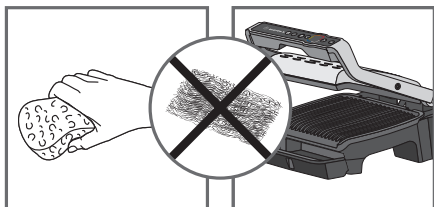

61

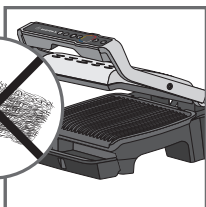

62



63

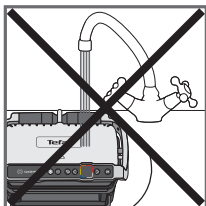

64

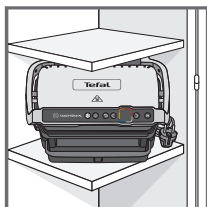

65

## 61-62

Um die Reinigung der Platten zu erleichtern, geben Sie sie eine Stunde in heißes Wasser und Spülmittel, und spülen Sie sie anschließend gründlich ab, um Rückstände zu entfernen. Wischen Sie die Platten sorgfältig mit einem Küchenpapier trocken.

Verwenden Sie keine metallischen Scheuerschwämme, Stahlwolle oder scheuernde Reinigungsmittel, um eines der Elemente des Grills zu reinigen. Verwenden Sie nur Nylonschwämme oder nicht metallische Schwämme.

Entleeren Sie die Saftauffangschale und waschen Sie sie in heißem Seifenwasser ab. Wischen Sie die Schale dann gründlich mit einem Küchenpapier trocken.

**63** Wischen Sie den Grilldeckel mit einem mit heißem Wasser angefeuchteten Schwamm sauber und trocknen Sie ihn dann mit einem weichen und trockenen Tuch ab. Verwenden Sie zum Reinigen des Bedienfeldes nur ein weiches und trockenes Tuch.

**64** Tauchen Sie das Gehäuse des Grills niemals in Wasser oder eine andere Flüssigkeit.



**65** Vergewissern Sie sich stets, dass der Grill sauber, abgekühlt und trocken ist, bevor Sie ihn wegräumen.

Alle anderen Wartungsarbeiten müssen von einem zugelassenen Kundendienst durchgeführt werden.

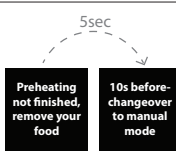

# Fehlerbehebung

DE



## FEHLERBEHEBUNG FÜR DEN ELITE

Problem	Ursache	Lösung
Ändern der Sprache		Grill mit einer Steckdose verbinden, auf ON und dann sofort die Taste Frozen drücken (währenddessen zeigt das Display „Bonjour“ an).
	Der Vorheizvorgang ist noch nicht abgeschlossen. Der Grill wurde vor Ende des Vorheizvorgangs geöffnet und Lebensmittel wurden auf die Platte gelegt.	Die Lebensmittel können gegrillt werden, der Garvorgang muss jedoch überwacht werden, denn der Grill hat in den manuellen Modus geschaltet. Die Temperatur kann eingestellt werden. Oder Grill öffnen, Speisen entnehmen, Grill ordnungsgemäß schließen und warten, bis der Vorheizvorgang abgeschlossen ist.
Ich kann mein Gerät nicht ausschalten.	Die Taste wurde nicht lange genug gedrückt oder zwischen dem ersten und zweiten Drücken war zu viel Zeit.	einmal die Ein-/Aus-Taste drücken, dann zur Bestätigung OK drücken.
Err 1 bis Err 8	Das Gerät wurde in einem zu kalten Zimmer aufbewahrt oder benutzt. Das Gerät ist überhitzt.	Netzstecker des Gerätes herausziehen und einige Minuten warten. Grill erneut mit der Steckdose verbinden und die Ein-/Aus-Taste drücken. Falls das Problem weiterhin besteht, kontaktieren Sie einen Kundendienst.
Err 9 bis Err 13	Funktionsstörung	Ziehen Sie den Netzstecker und wenden Sie sich an den Kundendienst.
Das Gerät schaltet sich während des Vorheiz- oder Garvorgangs von allein aus.	Das Gerät stand zu lange offen, während des Garvorgangs. Das Gerät stand nach Abschluss des Vorheizvorgangs oder während des Warmhaltens zu lange offen	Netzstecker ziehen und einige Minuten warten. Dann wieder mit der Steckdose verbinden und einschalten.
	Aufforderung, das Ende des Garvorgangs zu bestätigen	2 Lösungen OK drücken, wenn alle Lebensmittel entnommen wurden oder nicht OK drücken und den Grill laufen lassen, wenn noch Lebensmittel übrig sind, die gegart werden müssen.

## FEHLERBEHEBUNG FÜR DEN ELITE

Problem	Ursache	Lösung
	Lebensmittel wird nicht erkannt, weil es zu dünn ist.	OK drücken, um den Garvorgang zu starten.
	Lebensmittel sind zu dick.	2 Lösungen: OK drücken, um den Garvorgang im manuellen Modus fortzusetzen. oder Lebensmittel vom Grill nehmen, um sie dünner zu schneiden und den Garvorgang im automatischen Modus fortsetzen zu können.
Ich kann im manuellen Modus keine Temperatur einstellen.	Das Display bleibt auf der Temperatureinstellung stehen.	Einmal OK drücken, um zur Einstellung der Temperatur zu gehen, dann mithilfe der Pfeile einstellen. Mit OK bestätigen.  

## Garstufe für jedes automatische Programm

GRILLTIPPS		
PRODUKTE	GAR-PROGRAMM	GRILL-TIPP
Schweinefilet mignon (ohne Knochen), Schweinebauch		Durchgebraten*
Bratwurst (vorgegartes Schweinefleisch)		220°C/8 min 30
Rindswurst (vorgegartes Rindfleisch)		220°C/8 min 30
Nürnberger Wurst (vorgegartes Schweinefleisch)		220°C/4 min 30

# 16 AUTOMATISCHE PROGRAMME

DE

AUTOMATISCHE PROGRAMME		GARSTUFEN-ANZEIGE			
MENÜS		 Blue	 Rare	 Medium	 Well-done
	Rindfleisch	Blau	Blutig	Halbrosa	Durchgebraten
	Huhn	-	-	-	Durchgebraten
	Wurstchen	-	-	-	Durchgebraten
	Bacon	-	-	Halbrosa	Kross
	Hacksteak (Frikadelle)	-	Blutig	Halbrosa	Durchgebraten
	Panini	-	Leicht aufgebacken	Getoastet	Knusprig
	Fisch	-	Halbrosa	Gut durchgebraten	Durchgebraten
	Meeresfrüchte	-	Halbrosa	Gut durchgebraten	Durchgebraten
	Kartoffeln	-	-	-	Weich
	1 rote Paprika	-	-	Knackig	Weich
	Aubergine	-	-	-	Gegrillt
	Tomate	-	-	Knackig	Weich
	Schwein	-	-	Gut durchgebraten	Durchgebraten
	Vorgegarte Wurstchen	-	-	-	Weich
	Lamm	-	Halbrosa	Gut durchgebraten	Durchgebraten
	Vegetarisches Steak	-	-	-	Weich

# SPEZIELLER MANUELLER MODUS

## GEMÜSE ODER OBST

From 180°C to 195°C	From 220°C to 235°C	From 225°C to 270°C
-	-	Zucchini (Scheiben)
-	-	Spargel
-	-	Pilze
-	Zwiebeln	-
Brokkoli	-	-
Mini-Karotten	-	-
-	Fenchel	-
Süßkartoffel (Scheiben)	-	-
-	Apfel (Scheiben)	-
-	Ananas	-
-	Pfirsich	-

## ZUBEREITUNGSTIPP

Für Grillgut mit ausgeprägteren Grillstreifen wenden Sie das Grillgut am besten, bevor Sie es Ihren Gästen servieren.

PRODUKTE	ZUBEREITUNGSTIPP
KARTOFFELN	<ul style="list-style-type: none"> <li>• Der Länge nach in Scheiben schneiden</li> <li>• Geben Sie für ein optimiertes Garergebnis Öl auf die Zutaten.</li> </ul>
PAPRIKA	<ul style="list-style-type: none"> <li>• Der Länge nach halbieren</li> </ul>
AUBERGINE	<ul style="list-style-type: none"> <li>• Der Länge nach in Scheiben schneiden</li> <li>• Für ein optimiertes Garergebnis Öl auf die Zutaten geben.</li> </ul>
TOMATE	<ul style="list-style-type: none"> <li>• Runde Tomaten verwenden</li> <li>• Keine überreifen Tomaten verwenden.</li> <li>• Der Breite nach halbieren</li> <li>• Für ein optimales Garergebnis die gerundete Seite der Tomatenhälfte auf die untere Platte des Grills legen.</li> </ul>
SCHWEINEFLEISCH	* Funktion für intensivere Grillstreifen benutzen, wenn das Fleisch dicker als 20 mm ist.

# SAFETY INSTRUCTIONS

## IMPORTANT SAFEGUARDS

**Use, maintenance, cleaning and product installation guidelines: for your own safety, please read through all paragraphs of the instruction manual including the associated pictograms.**

**EN** This appliance is intended for indoor, domestic household use only. It is not intended to be used in the following applications, and the guarantee will not apply for:

- staff kitchen areas in shops, offices and other working environments;
- farm houses;
- by clients in hotels, motels and other residential type environments;
- bed and breakfast type environments.

Before first use remove all packaging materials, stickers and accessories from the inside and the outside of the appliance.

This appliance is not intended for use by persons (including children) with reduced physical, sensory or mental capabilities, or lack of experience and knowledge, unless they have been given supervision or instruction concerning use of the appliance by an adult responsible for their safety. Children should be supervised to ensure that they do not play with the appliance, and do not use as a toy.

This appliance can be used by children aged from 8 years and above and persons with reduced physical, sensory or mental capabilities or lack of experience and knowledge if they have been given supervision or instruction concerning use of the appliance in a safe way and understand the hazards involved. Cleaning and user maintenance shall not be made by children unless they are older than 8 and supervised.

Keep the appliance and its cord out of reach of children less than 8 years.

Never leave the appliance unattended when in use.

 Accessible surface temperatures can be high when the appliance is operating. Never touch the hot surfaces of the appliance.

This appliance is not intended to be operated by means of an external timer

or separate remote-control system.

Fully unwind the power cord before plugging in the appliance.

If the power supply cord is damaged, it must be replaced by the manufacturer or its after sales service in order to avoid any danger.

Do not use an extension lead. If you accept liability for doing so, only use an extension lead which is in good condition, has a plug with an earth connection and is suited to the power rating of the appliance. Take all necessary precautions to prevent anyone tripping over an extension cord.

Always plug the appliance into an earthed socket.

Make sure that the electric power supply is compatible with the power rating and voltage indicated on the bottom of the appliance.

Use a sponge, hot water and washing up liquid to clean the cooking plates.

Never immerse the appliance, its power cord or plug in water or any other liquid.

**WARNING:** Do not heat or pre-heat without the 2 cooking plates inside the grill.

## Do

- Read the instructions carefully, common to different models depending on the accessories your appliance with supplied with. Keep the instructions within reach.
- If an accident occurs, rinse the burn immediately with cold water and call a doctor if necessary.
- Before first use, wash the plates (see paragraph 11), pour a little cooking oil onto the plates and wipe with a soft cloth or paper kitchen towel.
- Position the power cord carefully, whether an extension is used or not, so that guests can move freely around the table without tripping over it.
- Cooking fumes may be dangerous for animals which have a particularly sensitive respiratory system, such as birds. We advise bird owners to keep them away from the cooking area.
- Always keep the appliance out of the reach of children.
- Check that both faces of the plate are clean before use.
- To prevent damage to the plates, only use them on the appliance for which they were designed (e.g., do not place in an oven, on the gas ring or electric hot-plate, etc.).
- Ensure that the plates are stable, well positioned and correctly clipped to the appliance. Only use the plates provided with the appliance or bought from an Approved Service Centre.
- Always use a wooden or plastic spatula to avoid damaging the cooking plates.
- Only use parts or accessories provided with the appliance or bought from an Approved Service Centre. Do not use them for other appliances or intention.

## Do not

- Do not use the appliance outside.
- Never leave the appliance unattended when plugged in or in use.
- To prevent the appliance from overheating, do not place it in a corner or below a wall cupboard.
- Never place the appliance directly on a fragile surface (glass table, tablecloth, varnished furniture, etc.) or on a soft surface such as a tea-towel.

- Never place the appliance under a cupboard attached to a wall or a shelf or next to inflammable materials such as blinds, curtains or wall hangings.
- Never place the appliance on or near hot or slippery surfaces; the power cord must never be close to or in contact with hot parts of the appliance, close to a source of heat or resting on sharp edges.
- Do not place cooking utensils on the cooking surfaces of the appliance.
- Never cut food directly on the plates,
- Do not use metal scouring pads, abrasive wire wool or harsh scouring powder as this may damage the nonstick coating.
- Do not move the appliance when in use.
- Do not carry the appliance by the handle or metallic wires.
- Never run the appliance empty.
- Do not use aluminium foil or other objects between the plate and the food being cooked.
- Do not remove the grease collection tray while cooking. If the grease collection tray becomes full when cooking: let the appliance cool down before emptying.
- Do not place the hot plate on a fragile surface or under water.
- To preserve the non-stick properties of the coating, avoid excessive pre-heating with the appliance empty.
- The plates should never be handled when hot.
- Do not cook food in aluminium foil.
- To avoid spoiling your appliance, do not use flambé recipes in connection with it at any time.
- Do not place a sheet of aluminum or any other object between the plates and the heating element.
- Never heat or cook whilst the grill is open.
- Never heat up the appliance without the cooking plates.

## Tips/information

- Thank you for buying this appliance, which is intended for domestic use only.
- For your safety, this appliance complies with the applicable standards and regulations - Low voltage directive - Electromagnetic compatibility - The environment - Materials in contact with food.
- On first use, there may be a slight odour and a little smoke during the first few minutes.
- Our company has an ongoing policy of research and development and may modify these products without prior notice.
- Do not consume foodstuff that comes into contact with the parts marked with logo .
- If the food is too thick, the safety system will stop the appliance from working.
- The instrument panel is fragile: clean, wipe and dry with a dry, soft cloth only. Do not clean it with a wet sponge as this may damage its functions.

## Environment



### Environment protection first!

- ① Your appliance contains valuable materials which can be recovered or recycled.
- ➡ Leave it at a local civic waste collection point.



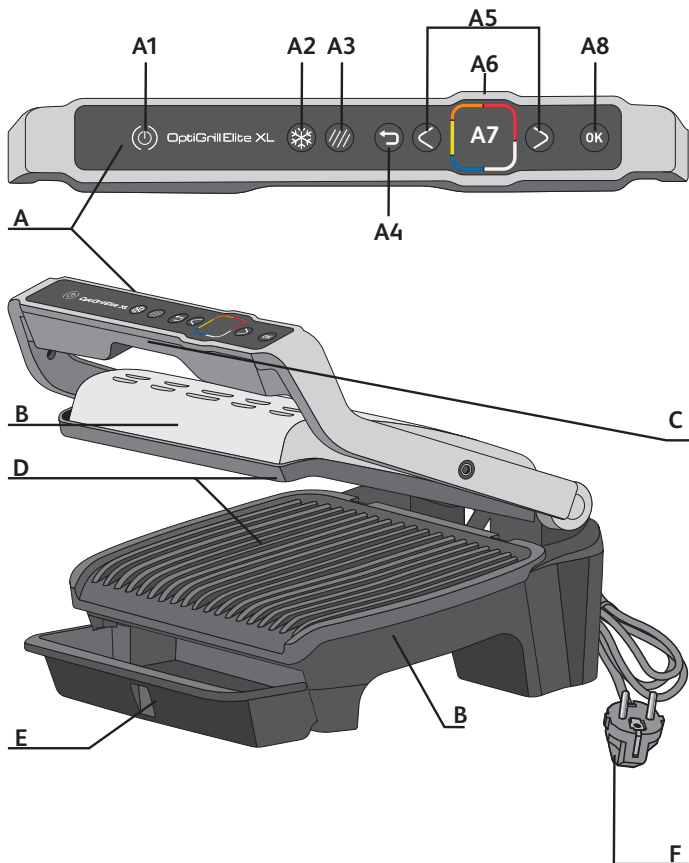

## Description

- |                                |  |                         |
|--------------------------------|--|-------------------------|
| <b>A</b> Control panel         | <b>A5</b> Adjustment and navigation buttons      | <b>B</b> Appliance body |
| <b>A1</b> On/Off button        | <b>A6</b> Preheating indicator and cooking level | <b>C</b> Handle         |
| <b>A2</b> Frozen food function | <b>A7</b> Display screen                         | <b>D</b> Cooking plates |
| <b>A3</b> Searing function     | <b>A8</b> OK button                              | <b>E</b> Drip tray      |
| <b>A4</b> Return button        |  | <b>F</b> Power cord     |

Buttons are only activated when they are lit up.

# 16 automatic cooking programs

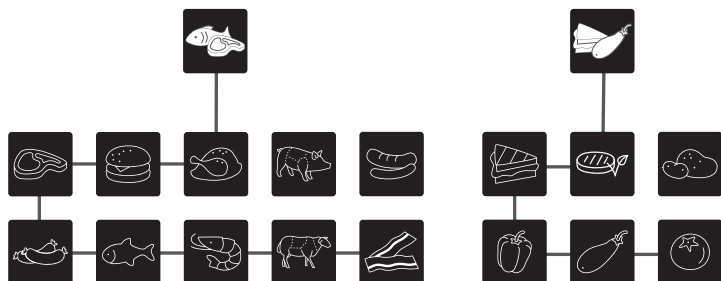

## Two additional cooking options in automatic mode



Frozen food function



Searing function

Note: The Frozen food function and Searing function can be used independently or both at the same time.

## Manual mode

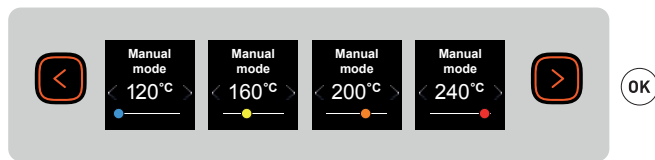

## Return button



If you are in a submenu and wish to return to the main menu, press once on the return button.

If you have selected the wrong program, press twice on the return button to cancel the function.

# 1 Before first use

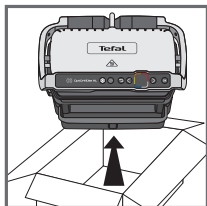
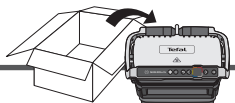

1

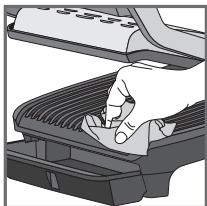

2

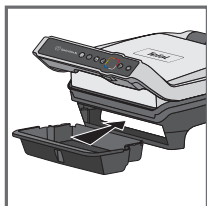

3



OK

4

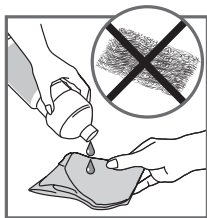

5



6

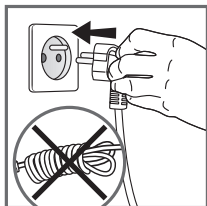

7

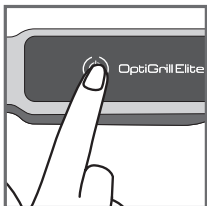

8

1 Remove all packaging, stickers and various accessories from both the inside and outside of the appliance.

2 Prior to first use, thoroughly clean the cooking plates using some hot water and some washing-up liquid, carefully rinse and dry.

3-4 Install the removable drip tray at the front of the machine.

5 If you wish, for best results and to improve the effectiveness of the non-stick surface, you can wipe the cooking plates with a paper towel dipped in a little cooking oil.

6 Remove any excess oil with a clean paper towel.

7 Make sure the top and bottom plates are correctly positioned in the appliance. Do not start preheating without the plates. Connect the appliance to the mains supply. (the cable must be completely unwound).

8 Press the On/Off button.

**Caution:** Ensure that there is no food between the plates.

EN

## 2 Using for the first time

9 Select your language using the arrows then press ok.



9

## 3 On/Off button

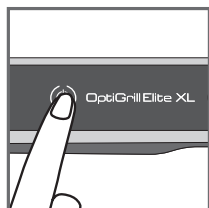

10

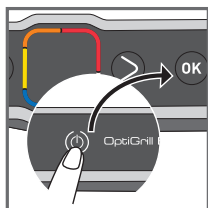

11

10 Switch on fig. 10.

11 To switch off the grill press once on the On/Off button and once on the OK button to switch off the appliance.

## 4 Frozen food function in automatic mode only

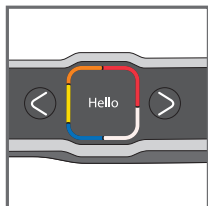

12



13

**13-15** Frozen food function must be activated before starting preheating, if the food to be cooked is frozen/deep frozen.

If you forget to activate the option, use the "return" button and repeat the steps.

This function is only available in automatic mode, not in manual mode.

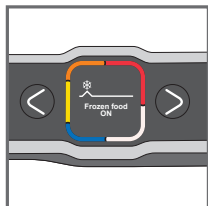

14

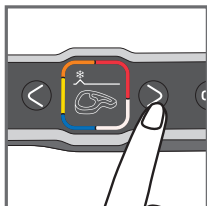

15

## 5 Searing function in automatic only

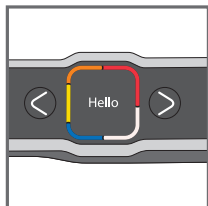

16

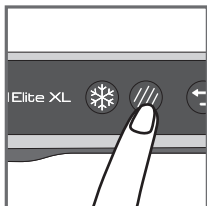

17

**17-19** Searing function must be activated before starting preheating, if you want significant searing on the food to be cooked.

If you forget to activate the option, turn off the appliance and repeat the steps.

This function is only available in automatic mode, not in manual mode.

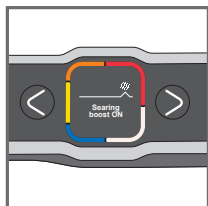

18

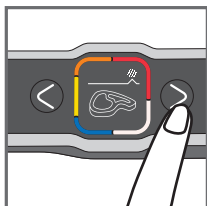

19

## 6 Cooking in automatic mode

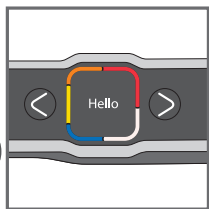

20

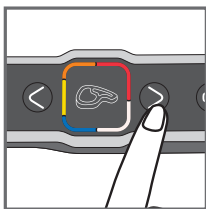

21

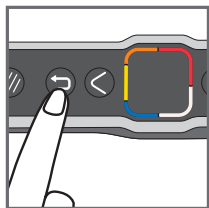

22

- 21** Select the appropriate cooking mode according to the type of food to be cooked.

**Note about meat:** the cooking results of the pre-defined programs may vary depending on the origin, the cut and the quality of the food to be cooked; the programs having been developed and tested with food of good quality.

Similarly, the thickness of the meat must be taken into account during cooking; you must not cook foods over 4 cm thick.

- 22** If you would like to change program, you can return to the main menu by pressing once on the return button.

If you are unsure of which cooking mode to use, please refer to the Cooking Guide, page 88.

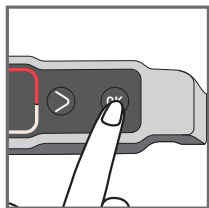

23



24

- 23** Press the **OK** button: the appliance starts to preheat.

**Note:** if you select the wrong program, use the "return" button.

- 24** Wait 4 to 7 minutes. Once the appliance has started to preheat, if you wish to change the program, press the return button and then the OK button to confirm and return to the main menu. Press the return button again to cancel the function.

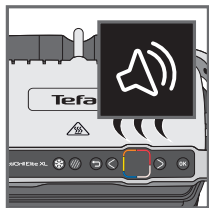

25

- 25** A beep sounds to signal that preheating is finished.

**Caution:** if the appliance remains closed for too long after preheating is finished, the safety system will turn off the appliance.

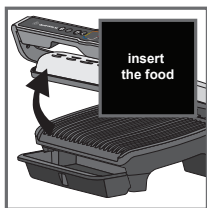

26

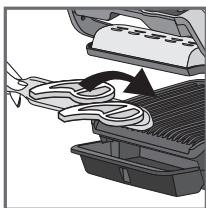

27

## 26-27

Once preheating has finished, you can insert your ingredients. Fully lift the grill lid and place the food on the grill.

**Caution:** if the appliance remains open for too long, the safety system will turn off the appliance.



28



29

## 28-31

The appliance automatically calculates the cooking cycle (time and temperature) according to the quantity and thickness of the food.

Close the appliance so that the cooking cycle can start.

**Note for very thin foods, such as bacon:** The "OK" button is on. Then press "OK" again to make sure that the appliance recognises the food and that the cooking cycle starts.



30

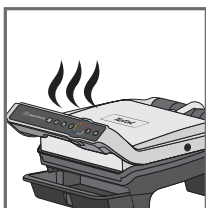

31

The arrow moves along the cooking level indicator and when it reaches a cooking level, the level is displayed and a beep sounds.

Note: the cooking levels are pre-programmed for each automatic mode.

During cooking, a beep will alert the user each time a cooking level is reached (e.g. rare/yellow).

Depending on the degree of cooking, the indicator changes colour and the cooking progress arrow moves on the screen.

Note, especially for meat, that it is normal for the cooking results to vary according to the type, quality and origin of the food.



32



33

## 32-33

At any time, you can find out the time remaining to reach the different levels of cooking. Press the right arrow if you want to see in how long before the next cooking level is reached. Note that this does not select the cooking levels. The grill continues to cook to the last cooking level and a beep sounds at each level.

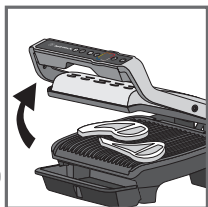

34

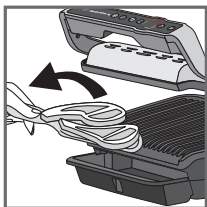

35

**34-35** When the cooking level of your choice is reached and the beep sounds, open the appliance and remove your food.

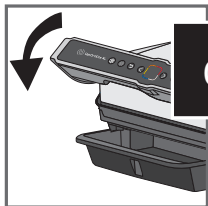

36



37

**36-37** Close the lid. The screen asks for your confirmation to stop cooking. Confirm with OK if all foods have been removed, otherwise allow it to continue cooking.

If you wish to cook more food, refer to section 8, page 81.

**Note:** the safety system will turn off the power automatically if no program is selected after a certain time.



## 7 How to cook a second batch

### Second batch of the same type of food

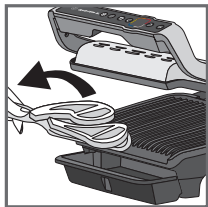

38



39

**38-39** At the end of the first cook, an "any refill" screen appears. If you want to grill the same type of food, press OK.

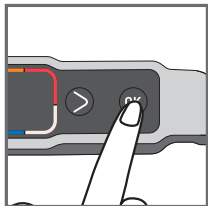

40



41

**40** The appliance starts preheating.

**41** Wait until preheating has finished.

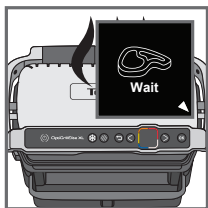

42

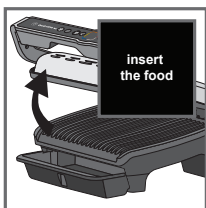

43

**42** Put the food on the grill.

**43** Then follow steps 26 to 36.

### Second cooking with a different type of food

Once cooking your first ingredient has finished:

1. Ensure that the appliance is closed and that there is no food inside.
2. Select the appropriate cooking program or mode.
3. Press the **OK** button to start preheating. During preheating, the preheating indicator is displayed on the screen.
4. Once preheating has finished, a beep sounds and the preheating information is shown on the screen.
5. The appliance is ready to use once preheating has finished. Lift the grill lid and place the food inside the grill. Then follow steps 26-36.

### Important:

– Preheating is essential to cooking.

Reminder: before starting preheating, ensure that the appliance is closed and that there is no food inside.

– Wait until preheating is finished before opening the grill and putting food inside.

**Note:** if the new preheating cycle is started immediately after the end of the previous cycle, the preheating time will be shorter.

## 8 Cooking in manual mode

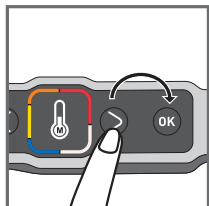

44

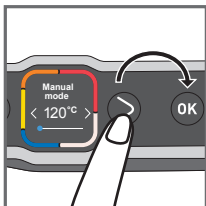

45

44 Select manual mode and press OK to confirm.

45 Select the desired temperature using the adjustment buttons. Please refer to manual cooking guide page 89.

Press OK to confirm the selected temperature.

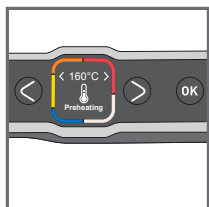

46

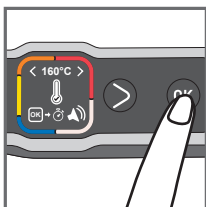

47

46 Wait until preheating has finished.

47 Once preheating has finished, press OK to start the timer.

**Note:** the cooking time can also be set from the start of preheating.

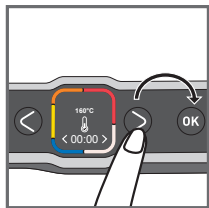

48

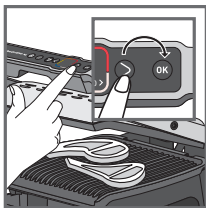

49

48 Press the adjustment buttons to select the desired cooking time.

49 Insert your food and press OK to start cooking and begin the countdown.

Press OK to adjust the temperature and/or the clock at any time.

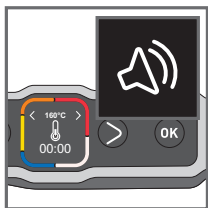

50

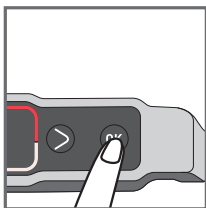

51

**50-51** A beep sounds to indicate when the cooking time has finished. Remove your food.

Press OK to stop the beeping and remove your food.

## 9 Comments

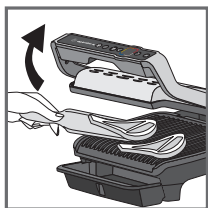

52

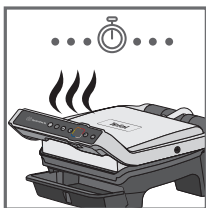

52

**52-54**

Depending on your personal preferences, open the grill and remove foods that have reached the desired cooking level, then close the grill to continue cooking other foods. The program will continue the cooking cycle until the last cooking level of the selected mode.

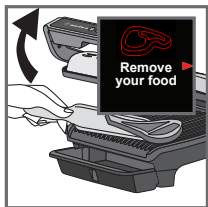

54



55

**55 Note:** the safety system will turn off the power automatically after a certain time.

## 10 End of use

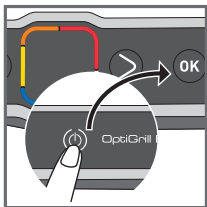

56

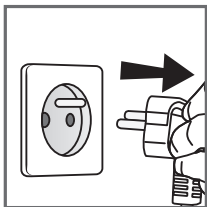

57

**56** Press the On/Off button and confirm by pressing the OK button.

**57** Unplug the appliance.

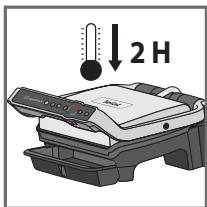

58

**58** Let it cool for at least 2 hours.

To prevent accidental burns, allow the grill to cool completely before cleaning.

## 11 Cleaning

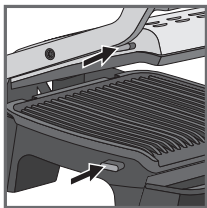

59

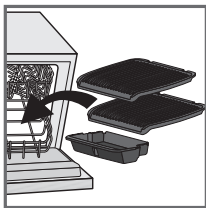

60

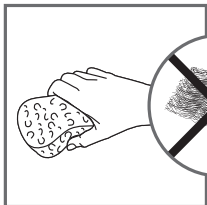

61

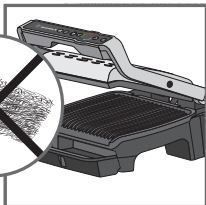

62



63

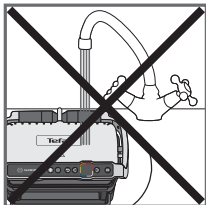

64

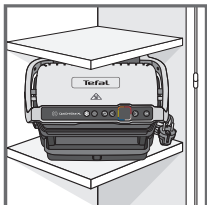

65

**59** To unlock the plates, press the release tabs on the left hand side of the appliance. Before cleaning, unlock and remove the plates to prevent damage to the cooking plates.

**60** The drip tray and cooking plates are dishwasher safe. The appliance and its power cord must never be put in the dishwasher. If you wash the plates in a dishwasher, always wipe the plates over with a little cooking oil on next use in order to condition the coating and ensure the best performance from the non-stick. The heating elements should never be cleaned after the plates have been removed. If they are very dirty, wait until the appliance has cooled down completely and clean them with a dry cloth.

**61-62**

To make washing the plates easier, soak them for 1 hour in hot water and some washing-up liquid, then rinse thoroughly to remove all residue. Dry them gently with a paper towel.

Do not use metal scouring pads, steel wool or abrasive cleaners to clean any part of the grill or cooking plates, use only nylon or non-metallic cleaning pads suitable for non-stick surfaces.

Empty the drip tray and wash it in warm, slightly soapy water, then wipe it thoroughly with a paper towel.

**63** To clean the grill lid, wipe with a sponge moistened with warm water and dry with a soft, dry cloth. To clean the control panel, use only a soft, dry cloth.

**64** The appliance must not be submerged in water or in any other liquid.

**65** Always ensure that the appliance is clean, cold and dry prior to storage. All repairs must be done by an authorised service centre.



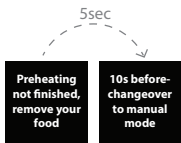

EN

# Troubleshooting Guide

## OPTIGRILL ELITE TROUBLESHOOTING GUIDE

Problem	Cause	Solution
A change of language		Switch on the grill, press ON, then immediately on the Frozen button (while the screen displays "Hello")
 <p>5sec</p> <p>Preheating not finished, remove your food</p> <p>10s before changeover to manual mode</p>	The preheating time was not completely finished. The grill was opened and the food placed on the plate before the end of preheating.	<p>It is possible to cook the food, but you have to check the cooking progress because the grill is in manual mode.</p> <p>The temperature can be adjusted.</p> <p>Or</p> <p>Open the grill, remove the food, close the grill properly and wait until the end of preheating.</p>
My appliance does not switch off	Missing a second press or too long a time between the 2 presses.	Press the On/Off button once then press OK
Err 1 to Err 8	The unit has been stored or used in a room that is too cold. Appliance overheating.	Unplug the appliance and wait a few minutes. Plug the grill in again and switch it on. If the problem persists, contact customer services.
Err 9 to Err 13	Appliance failure.	Unplug the appliance and contact customer services.
The appliance shuts down itself during the preheating or cooking cycle.	The appliance remained open for too long during cooking. The unit has been idle for too long after preheating or preheating has finished.	Unplug the appliance and wait a few minutes. Then plug in your appliance again and turn it on.

## OPTIGRILL ELITE TROUBLESHOOTING GUIDE

Problem	Cause	Solution
	End of cooking confirmation request	2 solutions: Press OK if all of the food has been removed Or Do not press OK and leave the food to cook a little longer
	Food not detected because it is too thin, for example bacon	Press OK to start cooking
	Food too thick, over 4 cm	2 solutions: Press OK to continue cooking in manual mode Or Remove the food and cut thinner to reduce the thickness, to allow cooking in automatic mode
I cannot set a time in manual mode	The screen is stuck on temperature setting	Press OK once to go to the time setting and then adjust it using the arrows. Press OK to confirm.  





















\* For the UK only: do not cook chicken breast from frozen. Always thaw completely first.

\*\* As bacon is a thin food, after closing the lid, press the "OK" button to make sure the appliance recognise the food and the cooking cycle starts.

\*\*\* For the UK only: For food safety reasons the Food Standards Agency do not advise serving rare or medium burgers. Only serve well done burgers.



# Cooking levels for each automatic program

## 16 AUTOMATIC PROGRAMS

AUTOMATIC PROGRAMS		COOKING LEVEL INDICATOR			
MENUS					
	Beef	Very rare (Blue)	Rare	Medium	Well done
	Chicken breast*	-	-	-	Well done
	Sausage	-	-	-	Well done
	Bacon**	-	-	Medium	Crispy
	Beef Burger***	-	-	-	Well done
	Panini	-	Lightly cooked	Toasted	Crispy
	Fish	-	Medium	Medium to well-done	Well done
	Seafood	-	Medium	Medium to well-done	Well done
	Potato	-	-	-	Soft
	Pepper	-	-	Crunchy	Soft
	Aubergine	-	-	-	Grilled
	Tomato	-	-	Crunchy	Soft
	Pork	-	Medium	Medium to well-done	Well done
	Pre-cooked sausages	-	-	-	Soft
	Lamb	-	Medium	Medium to well-done	Well done
	Vegetarian Steak	-	-	-	Soft



## COOKING ADVICE FOR OTHER FOODS

PRODUCTS	COOKING PROGRAM	COOKING TIP
Pork tenderloin (boneless), pork belly		Well done*
Bratwurst (pre-cooked pork)		220°C / 8 min 30 sec
Rindswurst (pre-cooked beef)		220°C / 8 min 30 sec
Nürnberger Wurst (pre-cooked pork)		220°C / 4 min 30 sec

## MANUAL MODE

### FRUIT OR VEGETABLES

From 180°C to 195°C	From 220°C to 235°C	From 225°C to 270°C
-	-	Courgette (slices)
-	-	Asparagus (whole)
-	-	Mushroom
-	Onion	-
Broccoli florets	-	-
Baby carrot	-	-
-	Fennel	-
Sweet potato (slices)	-	-
-	Apple (slices)	-
-	Banana	-
-	Peach (Stoned and sliced)	-

## OPTIGRILL ELITE PREPARATION ADVICE

For more significant searing, it is best to return the grilled food to the grill before serving it to your guests.

PRODUCTS	PREPARATION ADVICE
POTATO	<ul style="list-style-type: none"><li>• Cut lengthways</li><li>• Coat or brush the potato slices with oil for the best cooking results.</li></ul>
PEPPER	<ul style="list-style-type: none"><li>• Cut in half lengthway and remove seeds</li></ul>
AUBERGINE	<ul style="list-style-type: none"><li>• Cut lengthways</li><li>• Coat or brush the aubergine slices with oil for the best cooking results.</li></ul>
TOMATO	<ul style="list-style-type: none"><li>• Use round tomatoes</li><li>• Use tomatoes that are not too ripe</li><li>• Cut in half widthways</li><li>• For optimal cooking, place the rounded side of the halved tomato on the bottom plate of the grill.</li></ul>
PORK	* Use the searing function if the thickness is more than 20 mm.

# ISTRUZIONI DI SICUREZZA

## AVVERTENZE IMPORTANTI

**Utilizzo, manutenzione, pulizia e installazione del prodotto: per la propria sicurezza, fare riferimento ai diversi paragrafi di questo manuale e ai simboli corrispondenti.**

Questo prodotto è destinato al solo uso domestico e in ambienti interni. Questo apparecchio non è destinato a essere utilizzato nei seguenti ambiti, pena l'annullamento della garanzia:

- cucine riservate al personale di negozi, uffici o altri ambienti professionali;
- case coloniche;
- stanze di alberghi, motel e altri edifici residenziali;
- camere in affitto e altri ambienti analoghi.

Prima del primo utilizzo, rimuovere tutti i materiali di imballaggio, gli adesivi e gli accessori dalle superfici esterne e interne dell'apparecchio.

Questo apparecchio non deve essere usato da persone (compresi i bambini) con ridotte capacità fisiche, sensoriali o mentali o prive di esperienza o conoscenza, a meno che non siano sorvegliate o siano state istruite sull'uso dell'apparecchio da una persona responsabile della loro sicurezza. Sorvegliare i bambini per accertarsi che non giochino con l'apparecchio.

Questo apparecchio può essere usato da bambini di età superiore a 8 anni e da persone con ridotte capacità fisiche, sensoriali o mentali o prive di esperienza o conoscenza, solo se supervisionati o istruiti sull'uso sicuro dell'apparecchio e se comprendono i rischi correlati. Le operazioni di pulizia e manutenzione ordinaria possono essere effettuate da bambini solo se di età superiore a 8 anni e supervisionati.

Tenere l'apparecchio e il cavo di alimentazione fuori dalla portata dei bambini di età inferiore a 8 anni.

Non lasciare l'apparecchio incustodito quando è in funzione.

 La temperatura delle superfici accessibili può essere alta quando l'apparecchio è in funzione. Non toccare le superfici calde dell'apparecchio.

Questo apparecchio non è progettato per essere attivato tramite timer esterni o telecomandi separati.

Svolgere completamente il cavo di alimentazione prima di collegare l'apparecchio alla presa di corrente.

Per motivi di sicurezza, se il cavo di alimentazione è danneggiato deve essere sostituito dal costruttore e dal suo centro di assistenza.

Non usare prolunghe elettriche. Se è necessario usare una prolunga, a proprio rischio, usare esclusivamente prolunghe in buone condizioni, dotate di spina con messa a terra e adatte alla potenza dell'apparecchio. Adottare le necessarie precauzioni per evitare che altre persone possano inciampare nel cavo della prolunga.

Collegare l'apparecchio esclusivamente a una presa dotata di messa a terra. Assicurarsi che la rete elettrica sia compatibile con la potenza e il voltaggio indicati sulla parte inferiore dell'apparecchio.

Per pulire le piastre di cottura, usare una spugna, acqua calda e detersivo per piatti.

Non immergere l'apparecchio, il cavo di alimentazione o la spina in acqua o altri liquidi.

**AVVERTENZA! Non riscaldare o pre-riscaldare l'apparecchio senza le 2 piastre di cottura.**

## **Che cosa fare**

- Leggere attentamente le istruzioni, comuni a diverse versioni a seconda degli accessori forniti insieme all'apparecchio, e conservarle a portata di mano.
- In caso di ustione, risciacquare immediatamente la parte lesa con acqua fredda e contattare un medico se necessario.
- Prima del primo utilizzo, lavare le piastre (consultare il paragrafo 11), versare un po' di olio di cottura sulle piastre e strofinarle con un panno morbido o della carta assorbente.
- Posizionare attentamente il cavo di alimentazione, con o senza prolunga, affinché le persone possano muoversi liberamente intorno al tavolo senza inciamparvi.

- I vapori di cottura possono essere nocivi per gli animali dotati di un sistema respiratorio particolarmente sensibile, ad esempio gli uccelli. Si raccomanda ai proprietari di uccelli di tenerli lontani dall'area di cottura.
- Tenere l'apparecchio fuori dalla portata dei bambini.
- Verificare che entrambi i lati delle piastre siano pulite prima dell'uso.
- Per evitare danni alle piastre, usarle esclusivamente con l'apparecchio per il quale sono state progettate (ad es. non usarle in forni, su fornelli o su piastre elettriche, ecc.).
- Assicurarsi che le piastre siano stabili, ben posizionate e fissate correttamente all'apparecchio. Usare esclusivamente le piastre fornite con l'apparecchio o acquistate presso un centro di assistenza autorizzato.
- Usare esclusivamente spatole in legno o plastica per evitare di danneggiare le piastre di cottura.
- Usare esclusivamente parti o accessori forniti con l'apparecchio o acquistati presso un centro di assistenza autorizzato. Non usarli con altri apparecchi o per altri scopi.

## Che cosa non fare

- Non usare l'apparecchio all'aperto.
- Non lasciare l'apparecchio incustodito quando è collegato all'alimentazione o è in funzione.
- Per evitare che l'apparecchio si surriscaldi, non posizionarlo in angoli o sotto un pensile.
- Non posizionare l'apparecchio direttamente su superfici fragili (tavoli in vetro, tovaglie, mobili laccati, ecc.) o morbide (strofinacci, ecc.).
- Non posizionare l'apparecchio sotto pensili o ripiani o in prossimità di materiali infiammabili come tende, persiane o tappezzerie.
- Non posizionare l'apparecchio sopra o in prossimità di superfici calde o scivolose; non posizionare il cavo di alimentazione in prossimità o a contatto con le parti calde dell'apparecchio, fonti di calore e bordi affilati.
- Non collocare utensili da cottura sulle superfici di cottura dell'apparecchio.
- Non tagliare mai gli alimenti direttamente sulle piastre.
- Non usare spugnette metalliche, pagliette d'acciaio o detersivi in polvere abrasivi per evitare di danneggiare il rivestimento antiaderente.
- Non spostare l'apparecchio mentre è in funzione.
- Non trasportare l'apparecchio tramite l'impugnatura o i cavi.
- Non usare l'apparecchio a vuoto.
- Non frapporte fogli di alluminio o altri oggetti tra le piastre e gli alimenti in cottura.
- Non rimuovere la vaschetta raccogli-grassi durante la cottura. Se la vaschetta raccogli-grassi si riempie completamente durante la cottura, lasciare che l'apparecchio si raffreddi prima di svuotarla.
- Non posizionare le piastre calde su superfici fragili o sotto l'acqua.
- Per preservare le proprietà antiaderenti del rivestimento, evitare un eccessivo pre-riscaldamento con l'apparecchio vuoto.
- Non maneggiare mai le piastre quando sono calde.
- Non cuocere gli alimenti avvolti in fogli di alluminio.
- Per evitare di danneggiarlo, non preparare ricette flambé con questo apparecchio.
- Non frapporte fogli di alluminio o altri oggetti tra le piastre e l'elemento riscaldante.
- Non riscaldare o cuocere alimenti quando la griglia è aperta.
- Non riscaldare l'apparecchio senza le piastre di cottura.

## Note e informazioni aggiuntive

- Grazie per aver acquistato questo apparecchio, destinato al solo uso domestico.
- Per la sicurezza degli utenti, questo apparecchio è conforme agli standard e alle norme applicabili: direttive Basso voltaggio, Compatibilità elettromagnetica, Ambiente, Materiali in contatto con gli alimenti.
- Durante il primo utilizzo, l'apparecchio potrebbe emettere un leggero odore e una scia di fumo.
- Il prodotto potrebbe subire modifiche senza preavviso a causa della politica aziendale di costante ricerca e sviluppo.
- Non consumare alimenti entrati a contatto con le parti contraddistinte dal logo .
- Se gli alimenti sono troppo spessi, il sistema di sicurezza causerà lo spegnimento dell'apparecchio.
- Il pannello di controllo è un componente fragile: pulirlo e asciugarlo esclusivamente con un panno morbido e asciutto. Non pulirlo con una spugna umida per evitare di danneggiarlo.

## Protezione ambientale



### Salvaguardiamo l'ambiente!



- ① L'apparecchio contiene materiali utili che possono essere recuperati o riciclati.
- ➡ Portarlo presso un apposito centro di raccolta affinché venga riciclato.

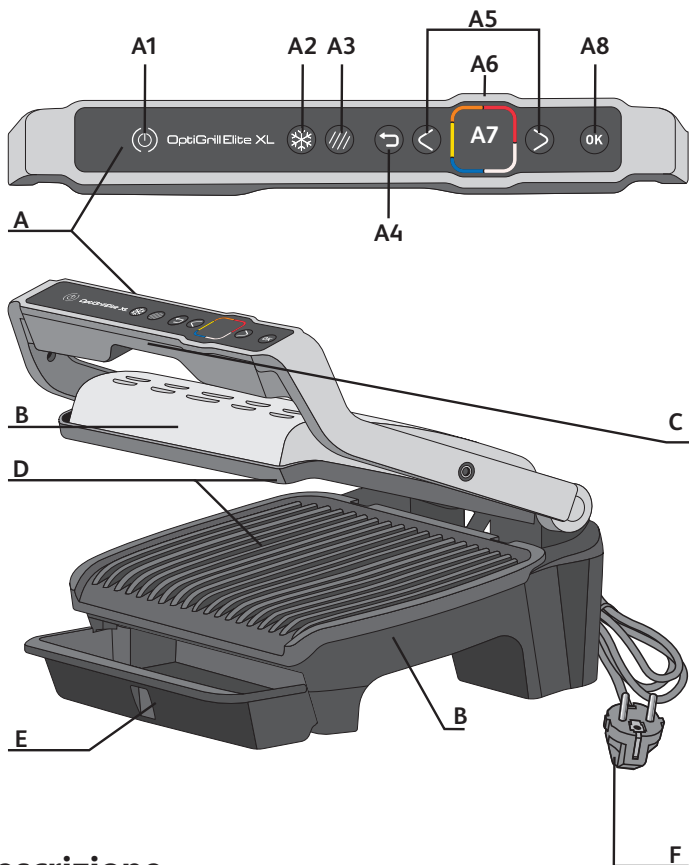

## Descrizione

- |                                       |  |                                    |
|---------------------------------------|--|------------------------------------|
| <b>A</b> Pannello di controllo        | <b>A5</b> Pulsanti di regolazione e navigazione                    | <b>B</b> Corpo dell'apparecchio    |
| <b>A1</b> Pulsante di avvio/arresto   | <b>A6</b> Indicatore del preriscaldamento e del livello di cottura | <b>C</b> Impugnatura               |
| <b>A2</b> Funzione Alimenti surgelati | <b>A7</b> Display  | <b>D</b> Piastre di cottura        |
| <b>A3</b> Funzione Grigliatura extra  | <b>A8</b> Pulsante OK  | <b>E</b> Vaschetta raccogli-grasso |
| <b>A4</b> Pulsante Indietro           |  | <b>F</b> Cavo di alimentazione     |

I tasti sono attivi solo quando sono accesi.

# 16 programmi di cottura automatica

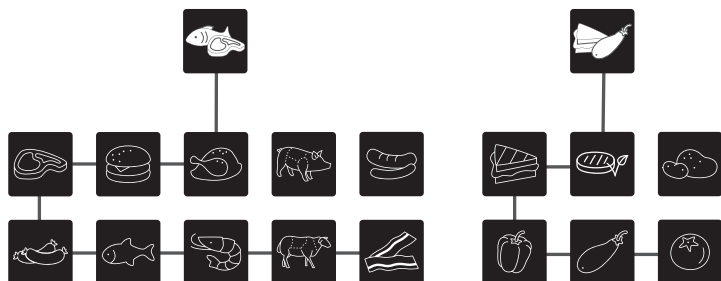

## Due funzioni di cottura in modalità automatica



Funzione Alimenti surgelati



Funzione Grigliatura extra

## Una modalità manuale

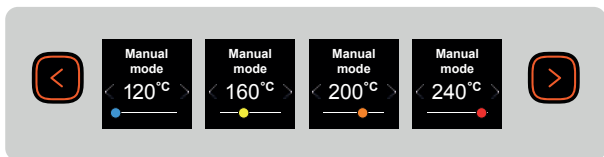

## Un pulsante Indietro



Se si è entrati in un sottomenu e si desidera tornare al menu principale, premere una volta il pulsante di ritorno.

Se si è scelto il programma sbagliato, premere due volte il pulsante Indietro per annullare la funzione.



# 1 Preparazione

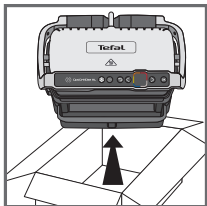
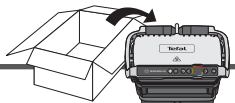

1

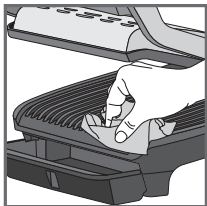

2



3



OK

4

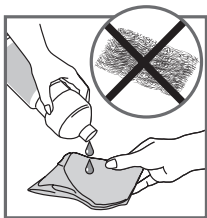

5



6

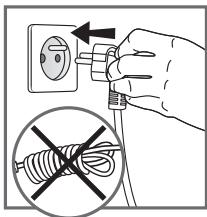

7

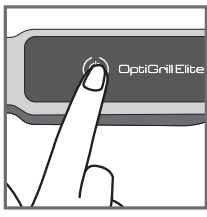

8

1 Rimuovere tutti i materiali di imballaggio, gli adesivi o gli accessori all'interno e all'esterno dell'apparecchio.

2 Prima di usare l'apparecchio per la prima volta, lavare accuratamente le piastre con acqua calda e detersivo per piatti, risciacquarle e asciugarle.

3-4 Installare la vaschetta raccogli-grasso removibile sulla parte anteriore dell'apparecchio.

5 Per ottenere migliori risultati e migliorare l'efficacia della superficie antiaderente, è possibile strofinare le piastre di cottura con della carta assorbente impregnata con un po' di olio di cottura.

6 Eliminare l'olio in eccesso con della carta assorbente asciutta.

7 Assicurarsi che le piastre di cottura superiore e inferiore siano posizionate correttamente nell'apparecchio. Non avviare il preriscaldamento senza piastre. Collegare l'apparecchio a una presa di corrente (il cavo di alimentazione deve essere completamente svolto).

8 Premere il pulsante di avvio/arresto.

**Attenzione!** Assicurarsi che tra le piastre non siano presenti alimenti.

IT

## 2 Primo utilizzo

9 Selezionare la lingua utilizzando le frecce e premere OK.



9

## 3 Avvio/arresto

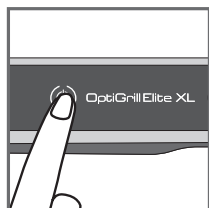

10

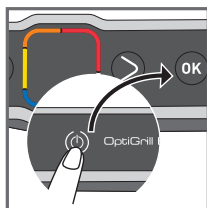

11

10 Accensione.

11 Per spegnere l'apparecchio, premere una volta il pulsante di avvio/arresto, quindi premere il pulsante OK.

## 4 Funzione Alimenti surgelati - in modalità automatica

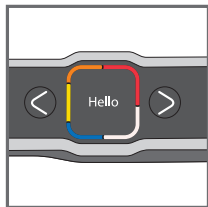

**Benvenuto**

**12**

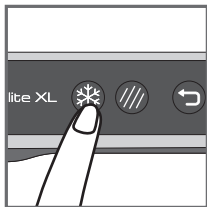

**13**

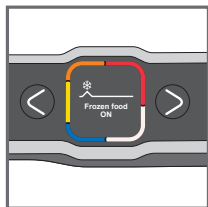

**Alimento surgelato  
disattivato**

**14**

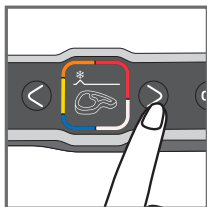

**15**

**13-15** La funzione Alimenti surgelati deve essere attivata prima di avviare il preriscaldamento, durante la selezione della modalità automatica, se gli alimenti da cuocere sono congelati/surgelati.

Se la funzione non è stata attivata, utilizzare il tasto "Indietro" e ricominciare da capo.

Questa funzione è disponibile esclusivamente in modalità automatica, e non in modalità manuale.

IT

## 5 Funzione Grigliatura extra - in modalità automatica

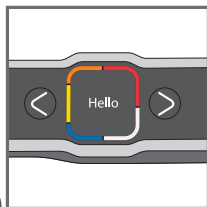

**Benvenuto**

**16**



**17**

**17-19** La funzione Grigliatura extra deve essere attivata prima di avviare il preriscaldamento, durante la selezione della modalità automatica, per ottenere dei segni di grigliatura più intensi.

Se la funzione non è stata attivata, spegnere l'apparecchio e ricominciare da capo.

Questa funzione è disponibile esclusivamente in modalità automatica, e non in modalità manuale.

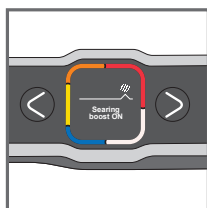

**Rosolatura extra attiva**

**18**

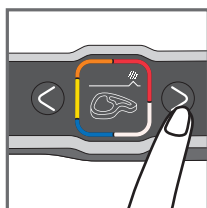

**19**

## 6 Cottura in modalità automatica

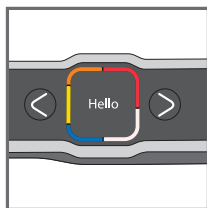

Benvenuto

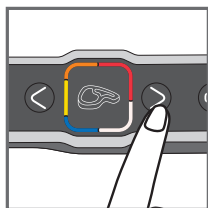

21

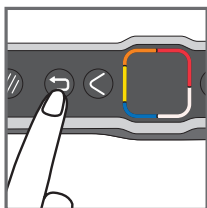

22

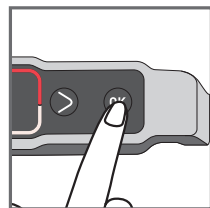

23



Pre riscaldamento  
in corso

24

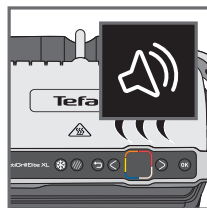

25

- 21 Selezionare la modalità di cottura appropriata a seconda del tipo di alimento.

**Suggerimento, in particolare per la carne:** i risultati di cottura dei programmi predefiniti possono variare a seconda dell'origine, del taglio e della qualità dell'alimento da cuocere; i programmi sono stati calibrati e testati con alimenti di qualità.

Inoltre, è necessario valutare lo spessore della carne: non è possibile cuocere alimenti con spessore a 4 cm.

- 22 Se si desidera modificare il programma, è possibile tornare al menu principale premendo una volta il pulsante Indietro.

- 23 Premere il pulsante "OK": l'apparecchio avvierà il preriscaldamento.

**Nota:** se è stato selezionato un programma per errore, utilizzare il tasto "Indietro".

- 24 Attendere da 4 a 7 minuti. Una volta avviato il preriscaldamento, se si desidera modificare il programma scelto, premere il pulsante Indietro, quindi confermare con il pulsante OK per tornare al menu principale. Premere due volte il pulsante Indietro per annullare la funzione.

- 25 Al termine del preriscaldamento verrà emesso un segnale acustico.

**Nota:** se l'apparecchio rimane inattivo per un certo periodo dopo il termine del preriscaldamento, il sistema di sicurezza spegnerà l'apparecchio.

IT

In caso di dubbi sulla modalità di cottura da utilizzare, consultare la guida di cottura a pagina 111.

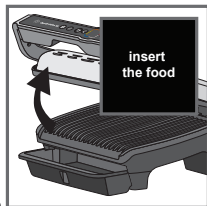

Inserire l'alimento

26

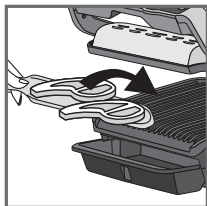

27



28

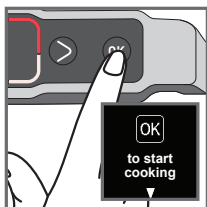

inizio cottura

29



Inizio della cottura

30



31

26-27

Al termine del preriscaldamento è possibile inserire gli alimenti. Sollevare il coperchio dell'apparecchio e disporre gli alimenti al suo interno.

**Nota:** se l'apparecchio rimane aperto troppo a lungo, il sistema di sicurezza spegnerà automaticamente l'apparecchio.

28-30

L'apparecchio calcola automaticamente i parametri di cottura (tempo e temperatura) in base alla quantità e allo spessore degli alimenti.

Chiudere l'apparecchio per avviare il ciclo di cottura.

**Nota per gli alimenti molto sottili come la pancetta:** il pulsante "OK" si accenderà. Premere il pulsante "OK" per fare in modo che l'apparecchio riconosca l'alimento e avvii la cottura.

La freccia si sposterà lungo l'indicatore del livello di cottura; al raggiungimento di un nuovo livello di cottura, tale livello apparirà sul display e verrà emesso un segnale acustico.

**Nota:** i livelli di cottura sono preimpostati per ciascun programma di cottura automatica.

Durante la cottura, ogni livello di cottura è indicato da un segnale acustico (ad es. al sangue/giallo).

A seconda del grado di cottura, l'indicatore cambierà colore e la freccia di progressione si sposterà sul display.

**Nota,** in particolare per la carne: è normale che i risultati di cottura varino in base al tipo, alla qualità e all'origine dell'alimento.



32



Ben cotta tra 01:35

33

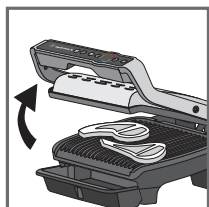

34

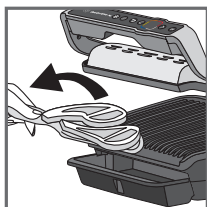

35

**32-33** È possibile visualizzare il tempo mancante al raggiungimento dei diversi livelli di cottura in qualsiasi momento. Premere la freccia di destra per visualizzare il tempo mancante al raggiungimento del livello di cottura successivo. Attenzione! Non si tratta di una selezione del livello di cottura. L'apparecchio proseguirà la cottura fino all'ultimo livello di cottura ed emetterà un segnale acustico al raggiungimento di ogni livello.

**34-35** Quando il livello di cottura desiderato appare sul display e viene emesso il segnale acustico, aprire l'apparecchio e rimuovere gli alimenti.

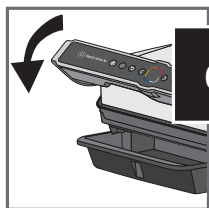

36



Arresto cottura

37

**36-37** Abbassare il coperchio. L'apparecchio chiederà conferma per arrestare la cottura. Premere il pulsante OK se tutti gli alimenti sono stati rimossi, altrimenti lasciare che la cottura prosegua. Se si desidera avviare una nuova cottura, tornare al passaggio 7.

**Nota:** il sistema di sicurezza spegnerà automaticamente l'apparecchio se non viene selezionato alcun programma entro un certo intervallo.

IT

## 7 Avvio di una seconda cottura

### Seconda cottura dello stesso tipo di alimento

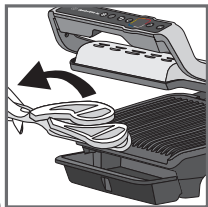

38



Un'altra cottura?

39

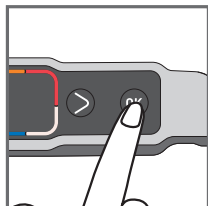

40



Pre riscaldamento in corso

41

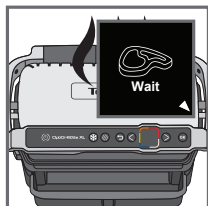

Attendere

42

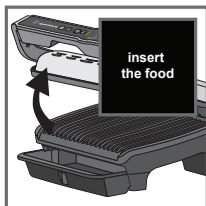

Inserire l'alimento

43

**38-39** Al termine della prima cottura, sul display apparirà "Nuova cottura?". Se si desidera cuocere lo stesso tipo di alimento, premere il pulsante OK.

**40** L'apparecchio avvia il preiscaldamento.

**41** Attendere il termine del preiscaldamento.

**42** Inserire gli alimenti nell'apparecchio.

**43** Seguire i passaggi da 27 a 37.

### Seconda cottura di un alimento diverso

Al termine della cottura del primo alimento, procedere come descritto di seguito.

1. Assicurarsi che l'apparecchio sia chiuso e che al suo interno non siano presenti alimenti.
2. Selezionare la modalità o il programma di cottura appropriato.
3. Premere il pulsante "OK" per avviare il preiscaldamento. Durante il preiscaldamento, l'indicatore del preiscaldamento apparirà sul display.



- Al termine del preriscaldamento verrà emesso un segnale acustico, e il display segnerà la fine del preriscaldamento.
- Al termine del preriscaldamento, l'apparecchio è pronto per la cottura. Sollevare il coperchio dell'apparecchio e disporre gli alimenti al suo interno. Seguire i passaggi da 27 a 37.

### Importante!

– Il preriscaldamento è obbligatorio per ogni cottura.

Nota: prima di avviare il preriscaldamento, assicurarsi che l'apparecchio sia chiuso e che al suo interno non siano presenti alimenti.

– Attendere il termine del preriscaldamento prima di aprire l'apparecchio e di inserire gli alimenti.

**Nota:** se la nuova fase di preriscaldamento viene avviata immediatamente dopo il termine della cottura, la sua durata sarà inferiore.

## 8 Cottura in modalità manuale

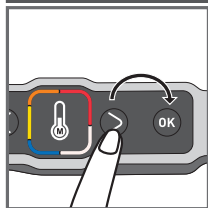

44

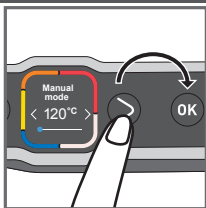

45

**44** Selezionare la modalità manuale e premere il pulsante OK per confermare.

**45** Selezionare la temperatura desiderata con i pulsanti di regolazione.

Premere il pulsante OK per confermare la temperatura selezionata.

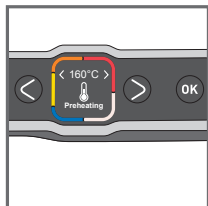

46

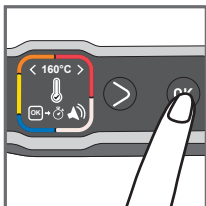

47

**45** Attendere il termine del preriscaldamento.

**47** Al termine del preriscaldamento, premere il pulsante OK Per avviare il timer.

**Nota:** il tempo di cottura può essere impostato anche all'inizio del preriscaldamento.

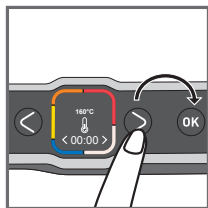

48

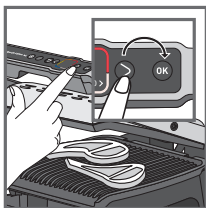

49

**48** Premere i pulsanti di regolazione per selezionare il tempo di cottura desiderato.

**49** Inserire gli alimenti e premere il pulsante OK per avviare la cottura e il conto alla rovescia.

In qualsiasi momento, premere il pulsante "OK" per impostare la temperatura e/o il tempo.

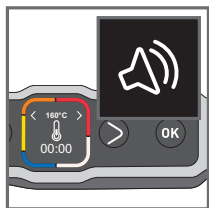

50

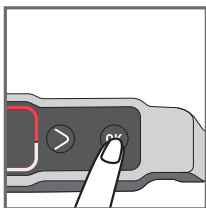

Arresto cottura

51

**50-51** Allo scadere del tempo di cottura verrà emesso un segnale acustico. Rimuovere gli alimenti.

Premere il pulsante OK per interrompere il segnale acustico e rimuovere gli alimenti.

## 9 Note

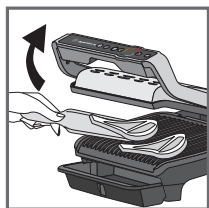

52

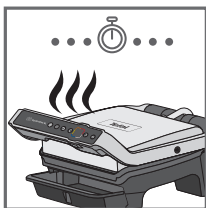

53

**52-54**

A seconda delle preferenze personali, aprire l'apparecchio e rimuovere gli alimenti che hanno raggiunto il livello di cottura desiderato, quindi richiudere l'apparecchio per proseguire la cottura degli altri alimenti. L'apparecchio proseguirà il ciclo di cottura fino all'ultimo livello di cottura della modalità selezionata.



Rimuovere l'alimento

54



Rischio di cottura eccessiva

55

**55 Nota:** il sistema di sicurezza spegnerà automaticamente dopo un certo intervallo.

## 10 Dopo l'uso

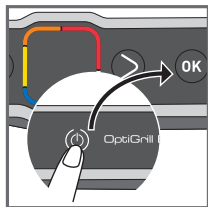

56

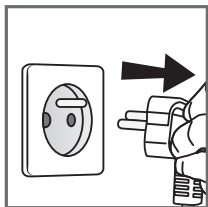

57

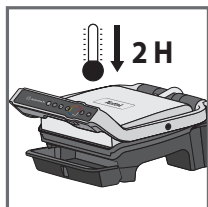

58

**56** Per spegnere l'apparecchi, premere il pulsante di avvio/arresto e confermare premendo il pulsante OK.

**57** Scollegare l'apparecchio dalla presa di corrente.

**58** Lasciare che l'apparecchio si raffreddi per almeno 2 ore.

Per evitare il rischio di ustioni, lasciare che l'apparecchio si raffreddi completamente prima di pulirlo.

IT

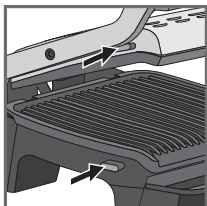

59

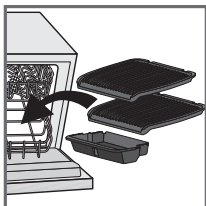

60

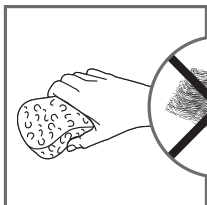

61

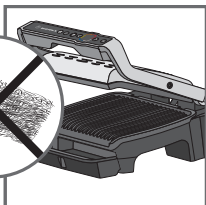

62

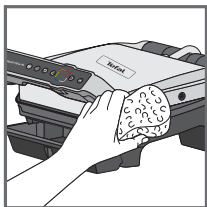

63

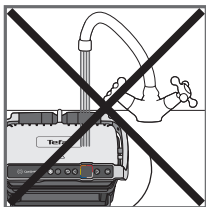

64

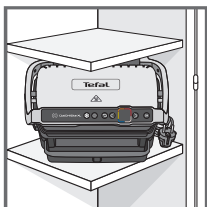

65

**59** Prima di pulire l'apparecchio, sbloccare e rimuovere le piastre per evitare di danneggiare la superficie di cottura.

**60** La vaschetta raccogli-grasso e le piastre di cottura possono essere lavate in lavastoviglie. L'apparecchio e il cavo di alimentazione non devono essere lavati in lavastoviglie. Gli elementi riscaldanti (le resistenze) non devono essere pulite dopo la rimozione delle piastre. Se sono molto sporche, attendere che l'apparecchio sia completamente freddo e pulirle con un panno asciutto.

**61-62**

Per facilitare la pulizia delle piastre, immergere per 1 ora in acqua calda e detersivo per piatti, quindi risciacquarle abbondantemente per eliminare ogni residuo. Asciugarle accuratamente con della carta assorbente.

Non usare spugne abrasive o metalliche o prodotti di pulizia abrasivi per pulire l'apparecchio; usare esclusivamente spugne in nylon o non metalliche.

Svuotare la vaschetta raccogli-grasso e lavarla con acqua calda e un po' di detersivo, quindi asciugarla accuratamente con della carta assorbente.

**63** Pulire il coperchio dell'apparecchio con una spugna imbevuta d'acqua e asciugarlo con un panno morbido e asciutto. Per pulire il contorno dello sportello, usare esclusivamente un panno morbido e asciutto.

**64** Non immergere il corpo dell'apparecchio in acqua o altri liquidi.

**65** Assicurarsi che l'apparecchio sia pulito, freddo e asciutto prima di riporlo.



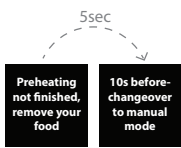

Qualsiasi altro intervento deve essere effettuato da un centro di assistenza autorizzato.

# Risoluzione dei problemi

## Risoluzione dei problemi ELITE





















Problema	Causa	Soluzione
Modifica della lingua.		Collegare l'apparecchio alla presa di corrente, accenderlo e premere immediatamente il pulsante Alimenti surgelati (mentre sul display appare "Bonjour").
	Il preriscaldamento non è terminato. L'apparecchio è stato aperto e gli alimenti sono stati inseriti sulla piastra prima del termine del preriscaldamento.	È possibile cuocere gli alimenti, ma è necessario sorvegliare la cottura perché l'apparecchio è passato in modalità manuale. La temperatura può essere regolata. Oppure Aprire l'apparecchio, rimuovere gli alimenti, chiudere l'apparecchio e attendere il termine del preriscaldamento.
L'apparecchio non si spegne.	Il pulsante non è stato premuto per la seconda volta, o è intercorso troppo tempo tra le 2 pressioni.	Premere una volta il pulsante di avvio/arresto e confermare premendo il pulsante OK
Da Err 1 a Err 8	L'apparecchio è stato riposto o utilizzato in un ambiente troppo freddo. L'apparecchio si è surriscaldato.	Scollegare l'apparecchio dalla presa di corrente e attendere qualche minuto. Collegare nuovamente l'apparecchio e premere il pulsante di avvio/arresto. Se il problema persiste, contattare il servizio clienti.
Da Err 9 a Err 13	Malfunzionamento dell'apparecchio.	Scollegare l'apparecchio dalla presa di corrente e contattare il servizio clienti.
L'apparecchio si arresta durante il ciclo di preriscaldamento o la cottura.	L'apparecchio è rimasto aperto troppo a lungo durante la cottura. L'apparecchio è rimasto inattivo troppo a lungo al termine del preriscaldamento o del mantenimento al caldo.	Scollegare l'apparecchio dalla presa di corrente e attendere qualche minuto. Ricollegare l'apparecchio e accenderlo.

## Risoluzione dei problemi ELITE



Problema	Causa	Soluzione
	Richiesta di conferma di fine cottura.	2 soluzioni: Premere il pulsante OK se tutti gli alimenti sono stati rimossi. Oppure Non premere il pulsante OK e lasciare che gli alimenti rimanenti continuino a cuocere.
	Alimento non rilevato perché è troppo sottile.	Premere il pulsante OK per avviare la cottura.
	Alimento troppo spesso.	2 soluzioni: Premere il pulsante OK per proseguire la cottura in modalità manuale. Oppure Rimuovere gli alimenti e ridurne lo spessore per permettere la cottura in modalità automatica.
Non è possibile impostare il tempo di cottura in modalità manuale.	Il display è in modalità di impostazione della temperatura.	Premere una volta il pulsante OK per passare all'impostazione del tempo di cottura e impostarlo con le frecce. Confermare con il pulsante OK.  

# Livelli di cottura per ciascun programma automatico

## 16 PROGRAMMI AUTOMATICI

PROGRAMMI AUTOMATICI		INDICATORE DEL LIVELLO DI COTTURA			
MENU		 Blue	 Rare	 Medium	 Well-done
	Manzo	Scottato	Al sangue	A puntino	Ben cotto
	Pollo	-	-	-	Ben cotto
	Salsiccia	-	-	-	Ben cotto
	Pancetta	-	-	A puntino	Croccante
	Carne trita (hamburger)	-	Al sangue	A puntino	Ben cotto
	Sandwich	-	Leggermente cotto	Tostato	Croccante
	Pesce	-	A puntino	Più che a puntino	Ben cotto
	Frutti di mare	-	A puntino	Più che a puntino	Ben cotto
	Patate	-	-	-	Fondenti
	Peperone	-	-	Croccante	Fondenti
	Melanzana	-	-	-	Grigliata
	Pomodoro	-	-	Croccante	Fondenti
	Maiale	-	-	Più che a puntino	Ben cotto
	Salsicce precotte	-	-	-	Fondenti
	Agnello	-	A puntino	Più che a puntino	Ben cotto
	Bistecca vegetariana	-	-	-	Fondenti

## SUGGERIMENTI DI COTTURA

ALIMENTI	PROGRAMMA DI COTTURA	SUGGERIMENTO DI COTTURA
Filetto mignon di maiale (senza osso), pancetta		Ben cotto *
Bratwurst (maiale precotto)		220°C / 8 min 30 sec
Rindswurst (manzo precotto)		220°C / 8 min 30 sec
Nürnberger Wurst (maiale precotto)		220°C / 4 min 30 sec

## MODALITÀ MANUALE SPECIALE

### VERDURA O FRUTTA

From 180°C to 195°C	From 220°C to 235°C	From 225°C to 270°C
-	-	Zucchina (fette)
-	-	Asparagi
-	-	Funghi
-	Cipolla	-
Broccoli	-	-
Carote baby	-	-
-	Finocchio	-
Patata dolce (fette)	-	-
-	Mela (fette)	-
-	Ananas	-
-	Pesca	-



## SUGGERIMENTI DI PREPARAZIONE

Per una grigliatura più intensa, si raccomanda di voltare l'alimento grigliato prima di servirlo.

ALIMENTI	SUGGERIMENTI DI PREPARAZIONE
PATATE	<ul style="list-style-type: none"><li>• Tagliarle per il lungo</li><li>• Aggiungere dell'olio per una cottura migliore</li></ul>
PEPERONI	<ul style="list-style-type: none"><li>• Tagliarli in due per il lungo</li></ul>
MELANZANE	<ul style="list-style-type: none"><li>• Tagliarle per il lungo</li><li>• Aggiungere dell'olio per una cottura migliore</li></ul>
POMODORI	<ul style="list-style-type: none"><li>• Utilizzare pomodori di forma rotonda</li><li>• Utilizzare pomodori non troppo maturi</li><li>• Tagliarli in due nel senso della larghezza</li><li>• Per una cottura ottimale, posizionare il lato arrotondato del pomodoro tagliato in 2 sulla piastra inferiore della griglia.</li></ul>
MAIALE	<p>* Utilizzare la funzione Grigliatura extra se lo spessore supera i 20 mm.</p>

# INSTRUCCIONES DE SEGURIDAD

## PRECAUCIONES IMPORTANTES

**Uso, mantenimiento, limpieza e instalación del producto: por motivos de seguridad, consulta los diferentes párrafos de estas instrucciones y los pictogramas correspondientes.**

Este aparato está diseñado para un uso exclusivamente doméstico. No ha sido concebido para utilizarse en los siguientes casos, que no están cubiertos por la garantía:

- en zonas de cocina reservadas para el personal de almacenes, oficinas y otros entornos profesionales,
- en granjas,
- por clientes de hoteles, moteles y otros espacios residenciales,
- en lugares como habitaciones de huéspedes.

Retire todos los envases, etiquetas y accesorios que hay tanto dentro como fuera del aparato.

Este aparato no está diseñado para que lo utilicen personas (incluidos niños) cuyas capacidades físicas, sensoriales o mentales sean reducidas, o por personas sin experiencia ni conocimientos, a no ser que la persona responsable de su seguridad las supervise o les haya proporcionado instrucciones previas sobre el funcionamiento del aparato.

Se recomienda vigilar a los niños para asegurarse de que no juegan con el aparato y que no lo utilizan como juguete.

Nunca deje el aparato en funcionamiento sin vigilancia.

 La temperatura de las superficies accesibles puede ser elevada cuando el aparato está en funcionamiento.

No toque las superficies calientes del aparato.

Este aparato no debe ponerse en marcha mediante un temporizador exterior ni por un sistema de mando a distancia externo.

Desenrolle el cable por completo.

Si el cable de alimentación está dañado debe ser reemplazado por el fabricante, su servicio de posventa o por personal cualificado para evitar cualquier peligro. Si se utiliza un alargador eléctrico, debe tener una sección equivalente y llevar toma de tierra incorporada. Adoptar todas las precauciones necesarias para que nadie tropiece con el alargador.

Conecte el aparato únicamente a un enchufe con toma de tierra incorporada. Compruebe que la instalación eléctrica es compatible con la potencia y la tensión indicadas debajo del aparato.

No sumerja este aparato. Nunca sumerja el aparato ni el cable en agua.

Este aparato puede ser utilizado por niños de 8 años o más y personas con capacidades físicas, sensoriales o mentales reducidas o personas sin experiencia ni conocimientos, siempre que hayan recibido instrucciones o supervisión sobre el uso seguro del aparato y conozcan los riesgos a los que se exponen. La limpieza y el mantenimiento que ha de realizar el usuario no deben ser efectuados por niños, salvo que tengan más de 8 años y estén vigilados. Mantenga el aparato y el cable de alimentación fuera del alcance de los niños menores de 8 años.

**ATENCIÓN** : no calentar ni precalentar el grill sin las 2 placas interiores.

## Qué debe hacer

- Lea atentamente y tenga a mano estas instrucciones, comunes a las diferentes versiones de los accesorios suministrados con el aparato.
- Si ocurre un accidente, aplique de inmediato agua fría sobre la quemadura y llame a un médico si fuera necesario.
- Antes del primer uso, lave las placas (véase el apartado 11), vierta unas gotas de aceite en las placas y séquelas con un paño suave.
- Tenga cuidado al colocar el cable con o sin alargador; tome todas las precauciones necesarias para no dificultar el paso de las personas alrededor de la mesa, de modo que nadie tropiece con él.
- Los humos de cocción pueden ser peligrosos para los animales que tengan un sistema de respiración especialmente sensible, como los pájaros. Aconsejamos a los propietarios de pájaros que los mantengan alejados del lugar de cocción.
- Mantenga siempre el aparato fuera del alcance de los niños.
- Compruebe que los 2 lados de la placa estén limpios antes de utilizar el aparato.
- Para evitar que se deterioren las placas, utilícelas únicamente con el aparatado para el que han sido diseñadas (ejemplo: no las introduzca en el horno, ni las coloque sobre fogones de gas o una placa eléctrica).

- Cuide de que las placas estén en una posición estable, bien colocadas y encajadas en la base del aparato. Utilice solamente las placas suministradas o adquiridas en el centro de servicio oficial.
- Para preservar el revestimiento de las placas de cocción, utilice siempre una espátula de plástico o madera.
- Utilice únicamente los accesorios suministrados con el aparato o comprados en un centro de servicio autorizado. No los utilice con otros aparatos.

## Qué no debe hacer

- No utilice el aparato en el exterior.
- Nunca deje conectado el aparato cuando no vaya a utilizarlo.
- Para evitar el sobrecalentamiento del aparato, no lo coloque en una esquina ni contra una pared.
- Nunca coloque el aparato directamente sobre una superficie frágil (mesa de vidrio, mantel, mueble barnizado, etc.) ni sobre un hule.
- Nunca coloque el aparato sobre un mueble fijado a la pared, sobre una estantería ni cerca de materiales inflamables como toldos, cortinas o estores.
- No coloque el aparato sobre o cerca de superficies resbaladizas o calientes, ni deje el cable colgando por encima de una fuente de calor (placas de cocción, cocinas de gas).
- No coloque utensilios de cocina en las superficies de cocción del aparato.
- No corte directamente sobre las placas.
- Nunca utilice esponjas metálicas ni detergente en polvo, para no dañar la superficie de cocción (revestimiento antiadherente).
- No desplace el aparato mientras esté en funcionamiento.
- No transporte el aparato cogiéndolo por el asa o los bordes metálicos.
- Nunca utilice el aparato vacío.
- No coloque nunca hojas de aluminio ni ningún otro objeto entre las placas y los alimentos que vaya a cocinar.
- No retire la bandeja de recogida de grasas durante la cocción. En caso de que la bandeja de recogida de grasas esté llena durante la cocción, deje enfriar el aparato antes de vaciarla.
- No coloque la placa caliente bajo el agua o sobre una superficie frágil.
- Para conservar las cualidades antiadherentes del revestimiento, evite calentar demasiado tiempo el aparato vacío.
- Las placas no se deben manipular nunca en caliente.
- No cocinar alimentos envueltos en papel de aluminio.
- Para evitar dañar el aparato, nunca realice recetas flambeadas sobre el mismo.
- No coloque nunca hojas de aluminio ni ningún otro objeto entre las placas y las resistencias.
- Nunca caliente ni realice ninguna cocción en posición «grill abierto».
- Nunca caliente el aparato sin las placas de cocción.

## Consejos/Información

- Le agradecemos que haya comprado este aparato, exclusivamente destinado a uso doméstico.
- Por su seguridad, este aparato cumple las normas y reglamentaciones aplicables (Directivas de Baja Tensión, Compatibilidad Electromagnética, Materiales en Contacto con Alimentos, Medio Ambiente, etc.).
- En la primera utilización puede desprenderse un ligero olor o humo.
- Para limpiar las placas de cocción, utilice una esponja, agua caliente y jabón de lavavajillas líquido.
- Nuestra empresa se reserva el derecho de modificar en cualquier momento, en interés del consumidor, las características o componentes de sus productos.

- No se puede consumir ningún alimento sólido o líquido que entre en contacto con piezas marcadas con el logo .
- Si los alimentos son demasiado espesos, el sistema de seguridad impide la puesta en marcha del aparato.
- La resistencia no se debe limpiar. Si está sucia de verdad, espere a que se enfríe totalmente y frótela con un paño seco.
- El panel de control es un elemento frágil, por lo que deberá limpiarlo, frotarlo y secarlo únicamente con un paño seco y suave. No lo limpie con una esponja mojada, ya que podría dañar sus funciones.

## Medio Ambiente



### ¡Colaboremos con la protección del medio ambiente!

- ① Su aparato contiene numerosos materiales recuperables o reciclables.
- ➔ Lleve el aparato a un punto de recogida de residuos o, en su defecto, a un centro de servicio autorizado para que pueda ser procesado.

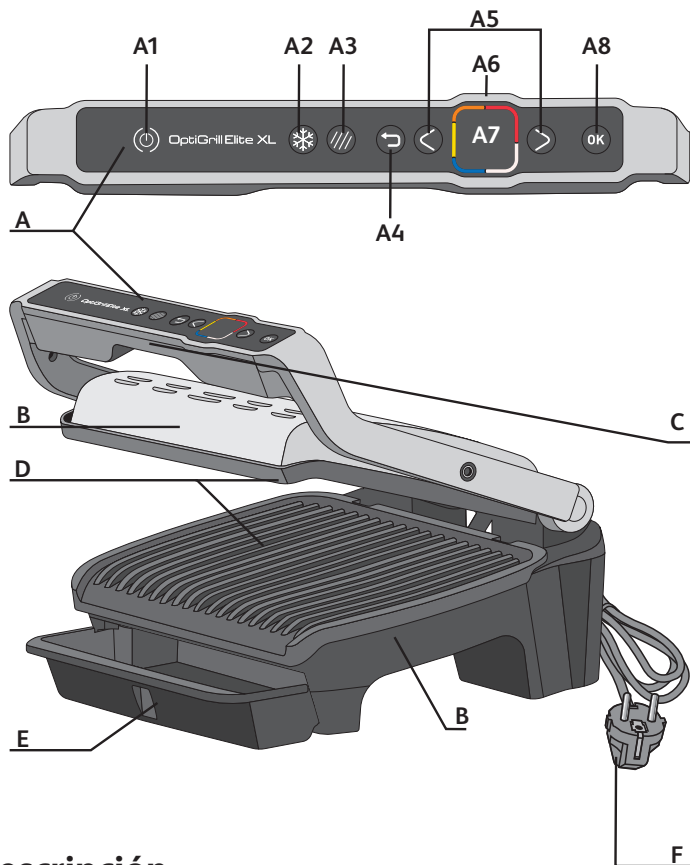

## Descripción

- |                                      |   |                                |
|--------------------------------------|---|--------------------------------|
| <b>A</b> Panel de control            | <b>A5</b> Botones de ajuste y de navegación                   | <b>B</b> Cuerpo del aparato    |
| <b>A1</b> Botón de encendido/apagado | <b>A6</b> Indicador de precalentamiento y de nivel de cocción | <b>C</b> Asa                   |
| <b>A2</b> Función Descongelar        | <b>A7</b> Pantalla de visualización                           | <b>D</b> Placas de cocción     |
| <b>A3</b> Función Churrascar         | <b>A8</b> Botón «OK» (Aceptar)                                | <b>E</b> Bandeja recogejugos   |
| <b>A4</b> Botón Atrás                |   | <b>F</b> Cable de alimentación |

Los botones se encuentran activos únicamente cuando están iluminados.

# 16 programas automáticos de cocción

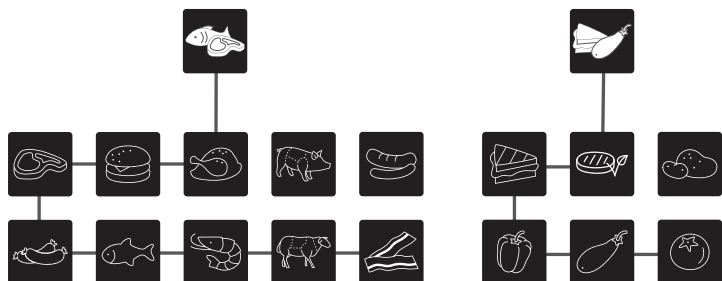

## Dos opciones de cocción posibles en modo automático



Función Descongelar



Función Churrascar

## Un modo manual

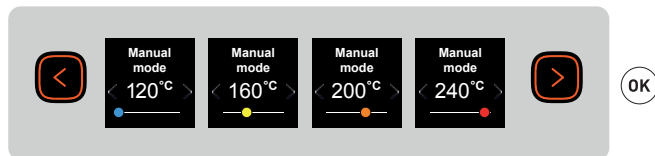

## Botón Atrás



Si has accedido a un submenú y quieres volver al menú principal, toca el botón Atrás una sola vez. Si te has equivocado de programa, toca dos veces el botón Atrás para anular la función.

# 1 Preparación

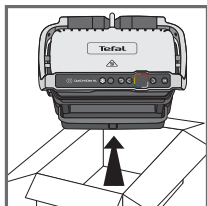
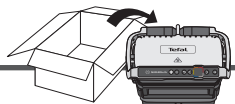

1

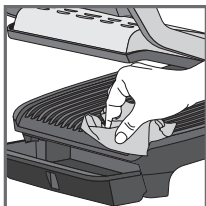

2

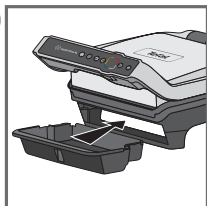

3



Bien

4

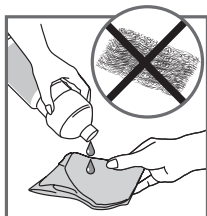

5



6

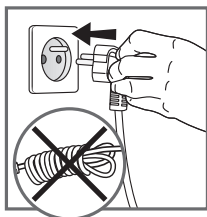

7

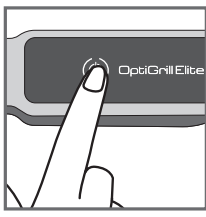

8

- 1 Retire todo el material de embalaje, así como los adhesivos y elementos de protección presentes tanto en el interior como en el exterior del aparato.
- 2 Antes de utilizar el aparato por primera vez, limpie cuidadosamente las placas con agua caliente y líquido lavavajillas, enjuáguelas y séquelas con cuidado.
- 3-4 Coloque la bandeja recogejugos extraíble en la parte delantera del aparato.

- 5 Si lo desea, para obtener los mejores resultados y mejorar la eficacia de la superficie antiadherente, puede frotar las placas de cocción con un papel de cocina impregnado con un poco de aceite de cocina.
- 6 Elimine todo el exceso de aceite con un papel de cocina limpio.

- 7 Asegúrese de que las placas superiores e inferiores están correctamente colocadas en el producto. No inicie el precalentamiento sin las placas. Conecte el aparato a la corriente. (Tenga en cuenta que el cable deberá estar totalmente desenrollado).
- 8 Pulse el botón de encendido/apagado.

**Atención:** Asegúrese de que no haya alimentos entre las placas.



## 2 Primer uso

- 9 Seleccione su idioma utilizando las flechas y, a continuación, pulse el botón «OK».



9

## 3 Encendido/apagado

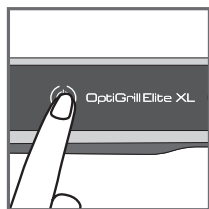

10

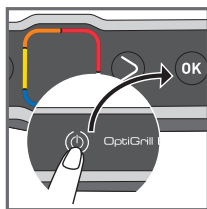

11

- 10 Encienda el aparato.

- 11 Para apagar el grill, pulse una vez el botón de encendido/apagado y una vez el botón «OK» para confirmar el apagado del aparato.

## 4 Función Descongelar (en modo automático)

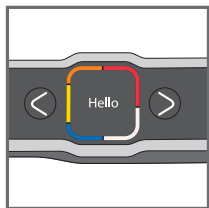

Hola

12



13

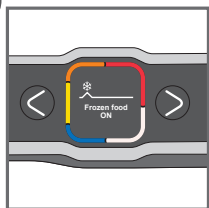

Alimento congelado  
desactivado

14

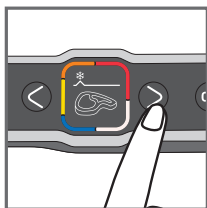

15

**13-15** Debe activar la función Descongelar antes de iniciar el precalentamiento, durante la selección del modo automático, si los alimentos que va a cocinar están congelados.

Si has olvidado activar la opción, utiliza el botón "Atrás" y empieza de nuevo cada fase.

Esta función solo está disponible en modo automático (en el modo manual no está disponible).

## 5 Función Churrascar (en modo automático)

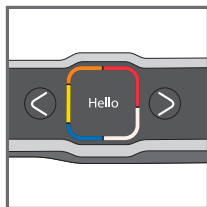

Hola

16



**17-19** Debe activar la función Churrascar antes de iniciar el precalentamiento, durante la selección del modo automático, si desea que los alimentos que va a cocinar se doren aún más.

Si ha olvidado activar esta función, apague el aparato y vuelva a realizar los pasos desde el principio.

Esta función solo está disponible en modo automático (en el modo manual no está disponible).

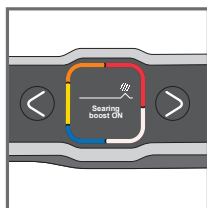

Dorado turbo activado

18

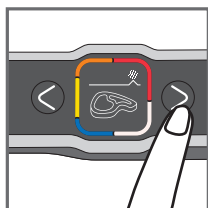

19



## 6 Cocción en modo automático

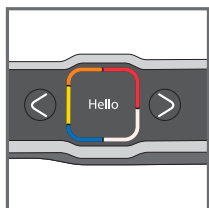

Hola  
20

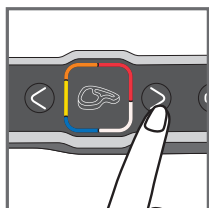

21

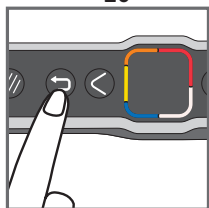

22

Si tiene dudas acerca del modo de cocción que debe utilizar, consulte las guías de cocción en la página 134.

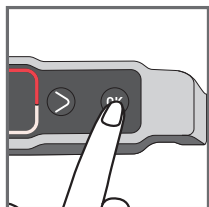

23



Precalentando

24

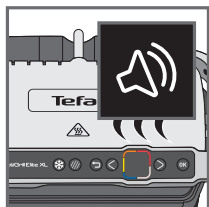

25

21 Seleccione el modo de cocción adecuado en función del tipo de alimento que vaya a cocinar.

**Consejo (especialmente para la carne):** los resultados de cocción de los programas preajustados pueden variar según el origen, el corte y la calidad del alimento que se cocine; los programas han sido ajustados y probados con alimentos de buena calidad.

Asimismo, debe tenerse en cuenta el grosor de la carne durante la cocción; no deberá cocinar alimentos de más de 4 cm de grosor.

22 Si quieres cambiar el programa, puedes ir al menú principal tocando el botón Atrás una sola vez.

23 Pulse el botón "OK" y el aparato comenzará el precalentamiento.

**Nota:** si te equivocas de programa, utiliza el botón "Atrás".

24 Espere de 4 a 7 minutos. Si quieres cambiar de programa una vez que se ha iniciado el precalentamiento, toca el botón Atrás y valida la acción con el botón OK para volver al menú principal. Si tocas el botón dos veces se anula la función.

25 Sonará una señal audible para indicar que ha finalizado el precalentamiento.

**Observación:** si el aparato permanece cerrado durante demasiado tiempo después de que haya finalizado el precalentamiento, el sistema de seguridad apagará el aparato.

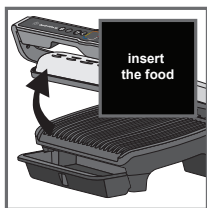

Introduzca el alimento

26

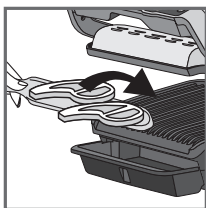

27



28

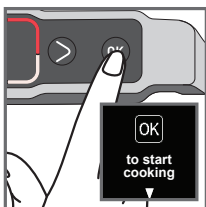

Para iniciar la cocción

29



Inicio de la cocción

30



31

26-27

Una vez haya finalizado el precalentamiento, puede introducir los ingredientes. Levante la tapa del grill e introduzca los alimentos en él.

**Observación:** si el aparato permanece abierto durante demasiado tiempo, el sistema de seguridad apagará automáticamente el aparato.

28-30

El aparato calcula automáticamente el ciclo de cocción (tiempo y temperatura) según la cantidad y el grosor de los alimentos.

Cierre el aparato para que comience el ciclo de cocción.

**Nota para los alimentos muy finos, por ejemplo, el beicon:** se encenderá el botón «OK». A continuación, pulse el botón «OK» para asegurarse de que el aparato reconoce correctamente el alimento y se inicia el ciclo de cocción.

La flecha se desplaza a lo largo del indicador del nivel de cocción y cuando alcanza un nivel de cocción, el nivel se muestra y suena una señal audible.

Nota: los niveles de cocción están preprogramados para cada modo automático.

Durante la cocción, una señal audible avisará al usuario cada vez que se alcance un nivel de cocción (p. ej.: poco hecho/amarillo).

Según el grado de cocción, el indicador cambiará de color y la flecha de progreso de la cocción se desplazará en la pantalla.

Tenga en cuenta, especialmente con la carne, que es normal que los resultados de cocción varíen según el tipo, la calidad y el origen de los alimentos.





32



**Muy hecho en 01:35**

33

**32-33** Puede conocer en cualquier momento el tiempo que falta para alcanzar los diferentes niveles de cocción. Pulse la flecha derecha si desea ver en cuánto tiempo se alcanzará el siguiente nivel de cocción. Atención, de esta forma no se seleccionan los niveles de cocción. El grill continuará cocinando hasta el último nivel de cocción y avisará cuando se alcance cada nivel.

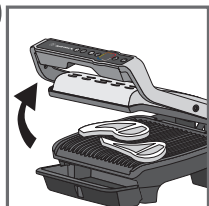

34

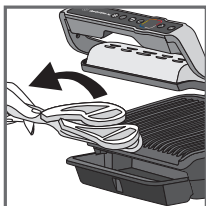

35

**34-35** Cuando se muestre el nivel de cocción que ha seleccionado y suene la señal audible, abra el aparato y retire los alimentos.

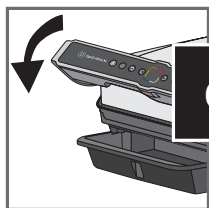

36



**Para detener la cocción**

37

**36-37** Baje la tapa. La pantalla le pedirá su confirmación para detener la cocción. Confirme pulsando el botón «OK» si ha retirado todos los alimentos; si no, deje que continúe la cocción.

Si desea realizar una nueva cocción, consulte el párrafo 7.

**Observación:** el sistema de seguridad apagará automáticamente el aparato si no se selecciona ningún programa al cabo de cierto tiempo.

## 7 Cómo realizar una segunda cocción

### Segunda cocción del mismo tipo de alimento

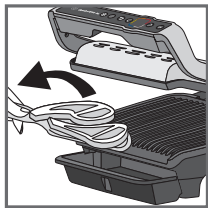

38



¿Añadir?

39

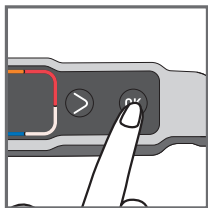

40



Precalentando

41

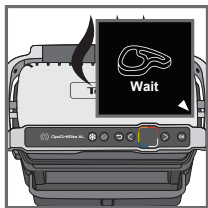

Esperar

42

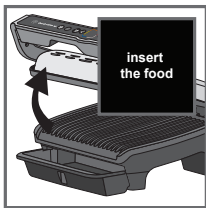

Introduzca el alimento

43

**38-39** Cuando haya terminado la primera cocción, aparecerá en la pantalla el mensaje «nouvelle cuisson» («nueva cocción»). Si desea asar el mismo tipo de alimento, pulse el botón «OK».

**40** El aparato comenzará el precalentamiento.

**41** Espere a que finalice el precalentamiento.

**42** Introduzca los alimentos en el grill.

**43** A continuación, siga los pasos 27 a 37.

### Segunda cocción de un ingrediente distinto

Cuando haya terminado la cocción de sus primeros ingredientes:

1. Asegúrese de que el aparato esté cerrado y de que no haya alimentos en su interior.
2. Seleccione el modo o programa de cocción adecuado.
3. Pulse el botón «OK» para comenzar el precalentamiento. Durante el precalentamiento, el indicador de precalentamiento aparecerá en la pantalla.
4. Cuando haya terminado el precalentamiento, sonará una señal audible y aparecerá en la pantalla la información del fin del precalentamiento.

5. El aparato estará listo para ser utilizado una vez haya terminado el precalentamiento. Levante la tapa del grill e introduzca los alimentos en el interior del aparato. A continuación, siga los pasos 27 a 37.

### Importante:

– Tenga en cuenta que el precalentamiento es obligatorio para cada cocción.  
Recuerde: antes de iniciar el precalentamiento, asegúrese de que el aparato esté cerrado y de que no haya.

– A continuación, espere a que haya terminado el precalentamiento antes de abrir el grill e introducir los alimentos en su interior.

**Nota:** si el nuevo ciclo de precalentamiento se inicia inmediatamente después del fin del ciclo anterior, el tiempo de precalentamiento será más corto.

## 8 Cocción en modo manual

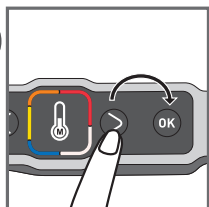

44

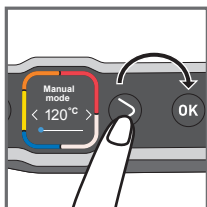

45

44 Seleccione el modo manual y pulse el botón «OK» para confirmar.

45 Seleccione la temperatura que desee pulsando los botones de ajuste.

Pulse el botón «OK» para confirmar la temperatura seleccionada.

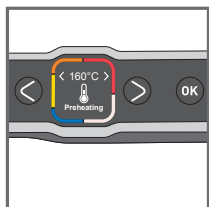

46

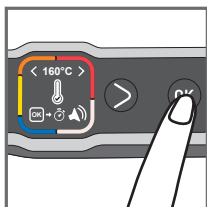

47

46 Espere a que finalice el precalentamiento.

47 Una vez haya terminado el precalentamiento, pulse el botón «OK» para iniciar el temporizador.

**Nota:** el tiempo de cocción también se puede ajustar desde el inicio del precalentamiento.

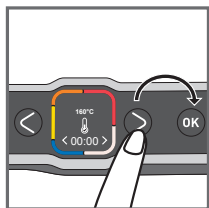

48

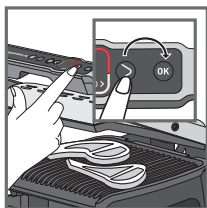

49

48 Pulse los botones de ajuste para seleccionar el tiempo de cocción que desee.

49 Coloca los alimentos y toca el botón OK para iniciar la cocción y la cuenta atrás de tiempo.

Puedes tocar el botón OK en cualquier momento para regular la temperatura o el tiempo.



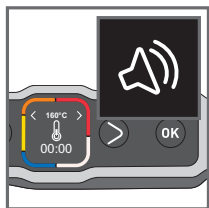

50

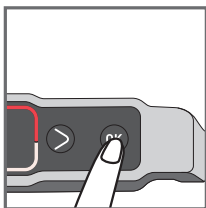

Para detener la cocción

51

**50-51** Una señal audible le avisará cuando haya finalizado el tiempo de cocción. Retire los alimentos.

Toca el botón OK para detener la señal acústica y retirar los alimentos.

## 9 Observaciones

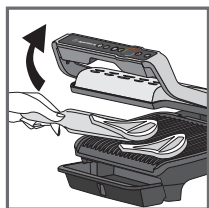

52

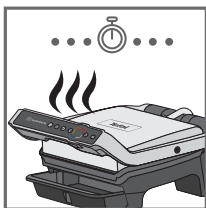

53

**52-54**

Según las preferencias personales, abra el grill y retire los alimentos cuando se haya alcanzado el nivel de cocción deseado; a continuación, vuelva a cerrar el grill para seguir cocinando los otros alimentos. El programa continuará el ciclo de cocción hasta el último nivel de cocción del modo seleccionado.



Saque el alimento

54



Riesgo de cocción excesiva

55

**55 Observación:** el sistema de seguridad apagará automáticamente el aparato al cabo de cierto tiempo.

## 10 Fin del uso

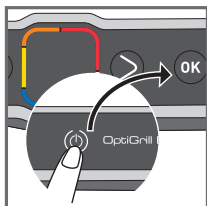

56

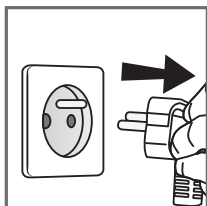

57

**56** Pulse el botón de encendido/apagado y confirme después pulsando el botón «OK».

**57** Desenchufe el aparato.

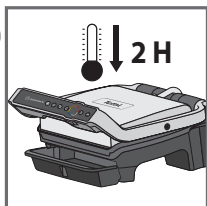

58

**58** Deje que se enfríe durante al menos 2 horas.

Para evitar quemarse accidentalmente, deje que el grill se enfríe totalmente antes de limpiarlo.

## 11 Limpieza

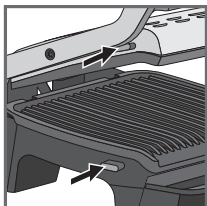

59

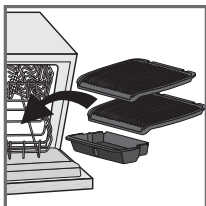

60

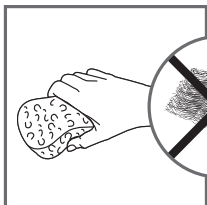

61

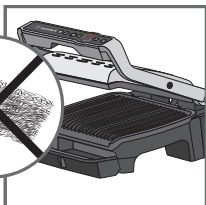

61



63



64

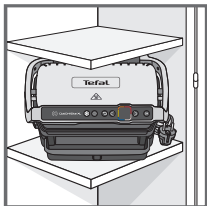

65

**59** Antes de limpiarlo, desbloquee y retire las placas para evitar dañar la superficie de cocción.

**60** La bandeja recogejugos y las placas de cocción son aptas para lavavajillas. No deberá introducir nunca el aparato ni su cable en el lavavajillas. Los elementos calefactores (las resistencias) nunca deberán limpiarse después de que se hayan quitado las placas. Si están muy sucios, espere a que el aparato se haya enfriado totalmente y límpielas con un paño seco.

**61-62**

Para limpiar las placas cómodamente, ponlas en remojo en agua caliente con jabón lavavajillas durante una hora y enjuágalas abundantemente para eliminar cualquier residuo. Sécalas con cuidado con papel de cocina.

No utilice un estropajo metálico, lana de acero ni productos de limpieza abrasivos para limpiar ninguna parte del grill, utilice únicamente estropajos de nailon o no metálicos.

Vacíe la bandeja recogejugos y lávela con agua caliente ligeramente jabonosa; a continuación, séquela cuidadosamente con un papel de cocina.

**63** Para limpiar la tapa del grill, pase una esponja ligeramente humedecida con agua caliente y séquela con un paño suave y seco. Para limpiar el panel de control, utilice únicamente un paño suave y seco.

**64** Nunca sumerja el cuerpo del grill en el agua ni en ningún otro líquido.

**65** Asegúrese siempre de que el grill está limpio, frío y seco antes de guardarlo. Cualquier reparación deberá realizarla un representante de un servicio técnico autorizado.

11

# Guía de resolución de problemas

## GUÍA DE RESOLUCIÓN DE PROBLEMAS DE ELITE

Problema	Causa	Solución
Cambio de idioma		Enchufe el Grill, pulse el botón de encendido, inmediatamente después pulse el botón Descongelar -mientras la pantalla muestre el mensaje «Bonjour» («Hola»).
 <p>5sec</p> <p>Preheating not finished, remove your food</p> <p>10s before-changeover to manual mode</p>	El tiempo de precalentamiento no había finalizado del todo. El grill se ha abierto y los alimentos se han colocado sobre la placa antes de que finalizara el precalentamiento.	Se pueden cocinar los alimentos, pero debe controlar la cocción, ya que el grill ha cambiado al modo manual. Puede ajustar la temperatura. O Abra el grill, retire los alimentos, cierre el grill correctamente y espere a que finalice el precalentamiento.
No puedo apagar el aparato.	Ha mantenido pulsado el botón durante un segundo menos o ha transcurrido demasiado tiempo entre las dos pulsaciones.	Pulse una vez el botón de encendido/apagado y, después, confirme pulsando el botón «OK».
Err 1 a Err 8	El aparato se ha guardado o utilizado en una habitación demasiado fría. El aparato tiene un sobrecalentamiento.	Desenchufe el aparato y espere unos minutos. Vuelva a enchufar el grill y pulse el botón de encendido. Si el problema persiste, contacte con el servicio de atención al cliente.
Err 9 a Err 13	Mal funcionamiento del aparato.	Desenchufe el aparato y contacte con el servicio de atención al cliente.
El aparato se apaga solo durante el ciclo de precalentamiento o de cocción.	El aparato ha permanecido abierto durante demasiado tiempo durante la cocción. El aparato ha estado sin utilizarse durante demasiado tiempo después de que finalizara el precalentamiento o el mantenimiento del calor.	Desenchufe el aparato y espere unos minutos. A continuación, vuelva a enchufar el aparato y enciéndalo.

## GUÍA DE RESOLUCIÓN DE PROBLEMAS DE ELITE



Problema	Causa	Solución
	Solicitud de confirmación del fin de la cocción.	2 soluciones: Si ha retirado todos los alimentos, pulse el botón «OK». O Si aún quedan alimentos por cocinar, no pulse el botón «OK» y deje que continúe la cocción.
	Alimento no detectado porque es demasiado fino.	Pulse el botón «OK» para iniciar la cocción.
	Alimento demasiado grueso.	2 soluciones: Pulse el botón «OK» para continuar la cocción en modo manual. O Retire los alimentos para reducir el grosor y permitir así una cocción en modo automático.
No consigo ajustar un tiempo en modo manual.	La pantalla se ha quedado fija en el ajuste de la temperatura.	Pulse una vez el botón «OK» para ir al ajuste del tiempo y, a continuación, ajústelo con las flechas. Confirme pulsando el botón «OK».  

# Niveles de cocción para cada programa automático

## 16 PROGRAMAS AUTOMÁTICOS

PROGRAMAS AUTOMÁTICOS		INDICADOR DEL NIVEL DE COCCIÓN			
MENÚS					
	Buey	Crudo	Poco hecho	Al punto	Muy hecho
	Pollo	-	-	-	Muy hecho
	Salchicha	-	-	-	Muy hecha
	Beicon	-	-	Al punto	Crujiente
	Carne picada (hamburguesa)	-	Poco hecha	Al punto	Muy hecha
	Panini	-	Poco cocido	Tostado	Crujiente
	Pescado	-	Al punto	Bastante hecho	Muy hecho
	Marisco	-	Al punto	Bastante hecho	Muy hecho
	Patata	-	-	-	Asada
	Pimiento	-	-	Crocante	Asado
	Berenjena	-	-	-	Asada
	Tomate	-	-	Crocante	Asado
	Cerdo	-	Al punto	Medio-muy hecho	Bien hecho
	Salsichas precocinadas	-	-	-	Blanda
	Cordero	-	Al punto	Medio-muy hecho	Bien hecho
	Filete vegetal	-	-	-	Blanda

## CONSEJOS DE COCCIÓN

PRODUCTOS	PROGRAMA DE COCCIÓN	CONSEJOS DE COCCIÓN
<i>Filet mignon</i> de cerdo (sin huesos), magro de cerdo		Muy hecho *
Bratwurst (cerdo precocido)		220 °C/8 min. 30
Rindswurst (buey precocido)		220 °C/8 min. 30
Nürnberger Wurst (cerdo precocido)		220 °C/4 min. 30

## MODO MANUAL ESPECIAL

### VERDURAS O FRUTAS

From 180°C to 195°C	From 220°C to 235°C	From 225°C to 270°C
-	-	Calabacín (en rodajas)
-	-	Espárragos
-	-	Setas
-	Cebolla	-
Brócoli	-	-
Zanahorias baby	-	-
-	Hinojo	-
Boniato (en rodajas)	-	-
-	Manzana (en rodajas)	-
-	Piña	-
-	Melocotón	-

## CONSEJOS DE PREPARACIÓN

Para unas parrilladas más doradas, le recomendamos que dé la vuelta a los alimentos asados antes de servirlos a sus comensales.

PRODUCTOS	CONSEJOS DE PREPARACIÓN
PATATA	<ul style="list-style-type: none"><li>• Corte en rodajas a lo largo.</li><li>• Eche aceite sobre los ingredientes para que se cocinen mejor.</li></ul>
PIMIENTO	<ul style="list-style-type: none"><li>• Corte por la mitad a lo largo.</li></ul>
BERENJENA	<ul style="list-style-type: none"><li>• Corte en rodajas a lo largo.</li><li>• Eche aceite sobre los ingredientes para que se cocinen mejor.</li></ul>
TOMATE	<ul style="list-style-type: none"><li>• Utilice tomates que tengan una forma redonda.</li><li>• Utilice tomates que no estén demasiado maduros.</li><li>• Corte por la mitad a lo ancho.</li><li>• Para una cocción óptima, coloque el lado redondeado del tomate cortado por la mitad sobre la placa inferior del grill.</li></ul>
CERDO	<ul style="list-style-type: none"><li>* Utilice la función Churrascar si el grosor es superior a 20 mm.</li></ul>



# INSTRUÇÕES DE SEGURANÇA PRECAUÇÕES IMPORTANTES

**Utilização, manutenção, limpeza e instalação do produto: para sua segurança, consulte os diferentes parágrafos deste manual e as respectivas imagens.**

Esse produto destina-se exclusivamente ao uso doméstico. Não foi concebido para ser usado nos seguintes casos, que não são abrangidos pela garantia:

- em zonas de cozinha reservadas aos funcionários nas lojas, escritórios e outros espaços profissionais;
- em quintas,
- por clientes de hotéis, motéis e outros espaços de natureza residencial,
- em ambientes de tipo quarto de hóspedes.

Retirar todo o material de embalagem, autocolantes ou outros acessórios, tanto no interior como no exterior do aparelho.

Este aparelho não foi concebido para ser utilizado por pessoas (incluindo crianças) cujas capacidades físicas, sensoriais ou mentais se encontram reduzidas, ou por pessoas com falta de experiência ou conhecimento, a não ser que tenham sido devidamente acompanhadas e instruídas sobre a correta utilização do aparelho por uma pessoa responsável pela sua segurança.

É importante vigiar as crianças para garantir que não brincam com o aparelho e que não o utilizam como um brinquedo.

Nunca deixe o aparelho a funcionar sem vigilância.

 A temperatura das superfícies acessíveis pode alcançar níveis elevados quando o aparelho está em funcionamento.

Não toque nas superfícies quentes do aparelho.

Esse aparelho não se destina a ser colocado em funcionamento com um temporizador exterior ou através de um sistema de comando à distância separado.

Desenrole totalmente o cabo.

Se o cabo de alimentação estiver danificado, deve ser substituído pelo fabricante, por um Serviço de Assistência Técnica autorizado ou por um técnico igualmente qualificado, por forma a evitar qualquer situação de perigo para o utilizador.

Se utilizar uma extensão elétrica, esta deve ter uma secção pelo menos equivalente, e ter uma tomada com ligação de terra incorporada. Tome as devidas precauções para que ninguém tropece.

O aparelho apenas deve ser ligado a uma tomada com ligação à terra incorporada. Certifique-se de que a instalação elétrica é compatível com a potência e a tensão indicadas por baixo do aparelho.

Este aparelho não pode ser mergulhado em líquidos. Nunca mergulhe o aparelho nem o cabo em água.

O aparelho pode ser utilizado por crianças a partir dos 8 anos ou mais e por pessoas com capacidades físicas, sensoriais e mentais reduzidas ou falta de experiência e conhecimentos, desde que tenham sido devidamente acompanhadas e instruídas sobre a utilização do aparelho em segurança e que compreendam os perigos envolvidos. A limpeza e a manutenção do mesmo por parte do utilizador não devem ser realizadas por crianças, a não ser que tenham mais de 8 anos e sejam supervisionadas. Mantenha o aparelho e o cabo de alimentação fora do alcance das crianças com menos de 8 anos.

**ATENÇÃO** : Não aqueça nem preaqueça o grelhador sem as duas placas colocadas no interior.

## O que pode fazer

- Leia atentamente estas instruções e guarde-as para futuras consultas. Estas instruções são as mesmas para as várias versões consoante os acessórios fornecidos com o aparelho.
- Caso ocorra um acidente, passe imediatamente água fria sobre a zona queimada e consulte um médico, se necessário.
- Quando utilizar o aparelho pela primeira vez, lave as placas (consulte o parágrafo 11), deite um pouco de óleo sobre as placas e limpe com um pano macio.
- Tenha atenção à localização do cabo, com ou sem extensão. Tome as devidas precauções para não perturbar a circulação das pessoas à volta da mesa e evitar que alguém tropece.
- Os fumos de cozedura podem ser perigosos para os animais com sistema respiratório particularmente sensível, como os pássaros. Aconselhamos os proprietários de pássaros a afastá-los do local de cozedura.
- Mantenha sempre o aparelho fora do alcance das crianças.
- Certifique-se de que as duas faces da placa estão bem limpas antes de utilizá-las.
- Para evitar danificar as placas, utilize-as apenas no aparelho para o qual foram concebidas (por ex.: não coloque num forno, sobre um fogão ou uma placa elétrica...).
- Certifique-se de que as placas estão estáveis, devidamente posicionadas e encaixadas na base do aparelho. Utilize apenas as placas fornecidas ou adquiridas num Serviço de Assistência Técnica autorizado.

- Para preservar o revestimento das placas de cozedura, utilize sempre uma espátula de plástico ou madeira.
- Utilize apenas os acessórios fornecidos com o aparelho ou adquiridos num Serviço de Assistência Técnica autorizado. Não utilize com outros aparelhos.

## O que não pode fazer

- Não utilize o aparelho no exterior.
- Nunca ligue o aparelho quando não é utilizado.
- A fim de evitar o sobreaquecimento, não o coloque num canto nem encostado a uma parede.
- Nunca coloque o aparelho diretamente sobre um suporte frágil (mesa de vidro, toalha, móvel envernizado, etc.) ou sobre um suporte de tipo toalha de plástico.
- Nunca coloque o aparelho por baixo de móveis fixados na parede, prateleiras, ou perto de materiais inflamáveis como estores, cortinas, tapetes.
- Não coloque o aparelho sobre ou junto a superfícies escorregadias ou quentes, nem deixe o cabo pendurado por cima de uma fonte de calor (placas de cozedura, fogões a gás, etc.).
- Nunca coloque utensílios de cozinha sobre as superfícies de cozedura do aparelho.
- Nunca corte os alimentos diretamente sobre as placas.
- Nunca utilize um esfregão metálico, nem pó abrasivo para não danificar a superfície de cozedura (ex: revestimento antiaderente).
- Não desloque o aparelho durante a sua utilização.
- Não transporte o aparelho pela pega nem pelos cabos.
- Nunca coloque o aparelho a funcionar em vazio.
- Nunca coloque uma folha de papel alumínio nem qualquer outro objeto entre as placas e os alimentos a cozinhar.
- Nunca retire a gaveta de recolha de sucos durante a cozedura. Se a gaveta de recolha de sucos ficar cheia durante a cozedura, deixe o aparelho arrefecer antes de esvaziá-la.
- Não coloque a placa quente debaixo de água ou sobre uma superfície frágil.
- Para conservar as qualidades antiaderentes do revestimento, evite deixar aquecer o aparelho vazio durante muito tempo.
- Nunca pegue nas placas enquanto estiverem quentes.
- Não coza em papelote.
- Para evitar a degradação do aparelho, não faça receitas de flambé.
- Nunca coloque uma folha de papel alumínio nem qualquer outro objeto entre as placas e as resistências.
- Nunca aqueça ou coza em posição «grelhador aberto».
- Nunca coloque o aparelho em funcionamento sem as placas de cozedura.

## Conselhos/Informações

- Obrigado por ter adquirido este aparelho, destinado exclusivamente a utilização doméstica.
- Para sua segurança, este aparelho está em conformidade com as normas e regulamentos aplicáveis (Diretivas Baixa tensão, Compatibilidade Eletromagnética, Materiais em contacto com os alimentos, Ambiente...).
- Aquando da primeira utilização, pode ocorrer uma ligeira libertação de cheiro ou fumo.
- Limpe as placas de cozedura com uma esponja, água quente e detergente para a louça.
- A nossa empresa reserva-se o direito de alterar a qualquer momento, para benefício do consumidor, as características ou componentes dos seus produtos.
- Qualquer alimento sólido ou líquido que entre em contacto com as peças marcadas com o símbolo  não deverá ser consumido.

- Se os alimentos forem demasiado espessos, o sistema de segurança impede o arranque do aparelho.
- A resistência não deve ser limpa. Se estiver muito suja, deixe-a arrefecer por completo e friccione-a com um pano seco.
- O painel de comandos é um elemento frágil: Limpe-o, e seque-o apenas com um pano suave e seco. Não limpe com uma esponja molhada. Corre o risco de danificar as suas funções.

## Ambiente



### Proteção do ambiente em primeiro lugar!



O aparelho contém vários materiais que podem ser recuperados ou reciclados.



Entregue-o num ponto de recolha para possibilitar o seu tratamento.

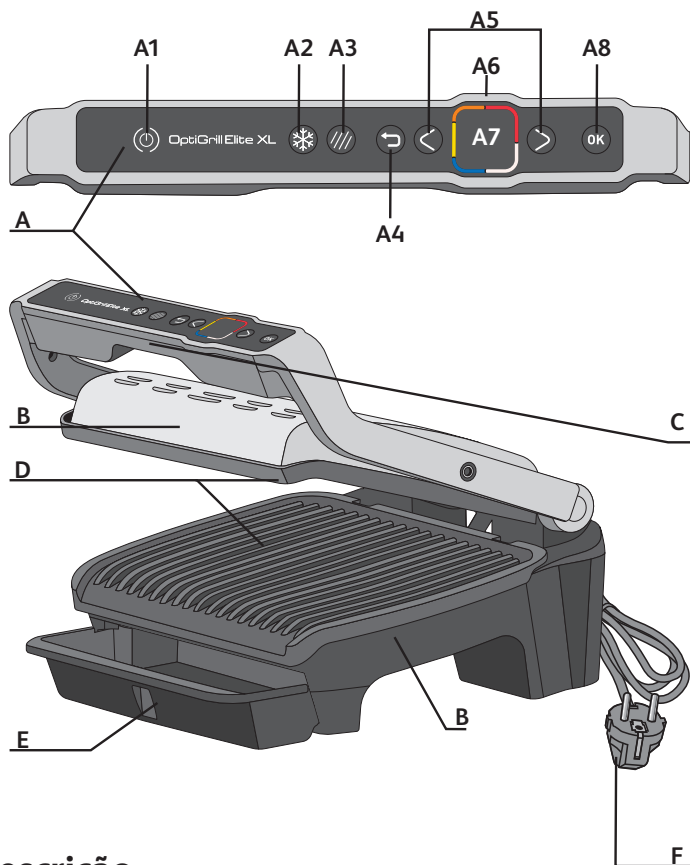

## Descrição

- |                                       |  |  |
|---------------------------------------|--|--|
| <b>A</b> Painel de comandos           | <b>A4</b> Botões de regulação e de navegação                   | <b>B</b> Corpo                           |
| <b>A1</b> Botão de ligar/desligar     | <b>A5</b> Indicador de pré-aquecimento e de nível de confeitão | <b>C</b> Pega                            |
| <b>A2</b> Função Alimentos congelados | <b>A6</b> Visor  | <b>D</b> Placas de confeitão             |
| <b>A3</b> Função Selar                | <b>A7</b> Botão OK   | <b>E</b> Tabuleiro para recolha de sucos |
| <b>A3</b> Botão de retroceder         |  | <b>F</b> Cabo de alimentação             |

Os botões encontram-se ativos apenas quando as luzes estão acesas.

# 16 programas de confeitão automáticos

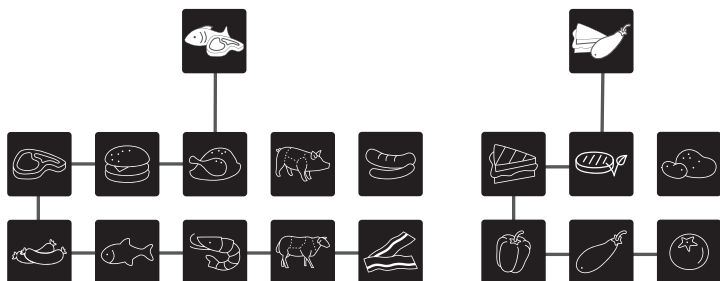

## Duas opções de confeitão possíveis no modo automático



Função de Alimento Congelado



Função Selar

## Um modo manual

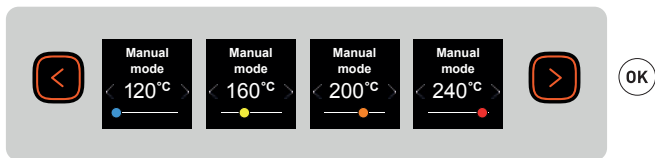

## Um botão de retroceder



Se tiver acedido a um submenu e pretender voltar ao menu principal, prima uma vez o botão de retroceder.

Se tiver seleccionado o programa errado, prima duas vezes o botão de retroceder para anular a função.

# 1 Preparação

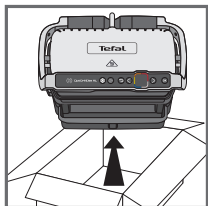
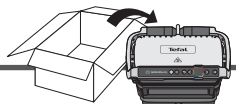

1

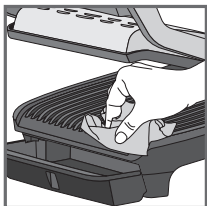

2

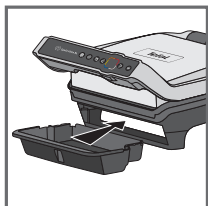

3



OK

4

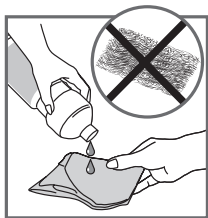

5



6

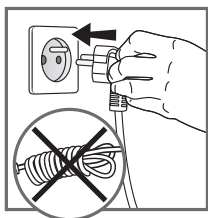

7

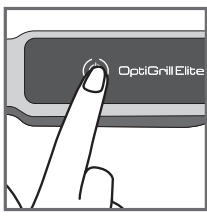

8

1 Retire todas as embalagens, autocolantes ou acessórios existentes tanto no interior como no do aparelho.

2 Antes da primeira utilização, lave cuidadosamente as placas com água quente e detergente para a loiça, passe por água e seque cuidadosamente.

3-4 Coloque o tabuleiro de recolha de sucos amovível parte da frente do aparelho.

5 Se desejar, para obter melhores resultados e melhorar a eficácia da superfície antiaderente, pode untar as placas de confeção com papel de cozinha embebido num pouco de óleo de cozinha.

6 Elimine o excesso de óleo com papel de cozinha limpo.

7 Certifique-se de que as placas superiores e inferiores estão corretamente posicionadas no aparelho. Não inicie o pré-aquecimento sem as placas. Ligue o aparelho a uma tomada. (Tenha em conta que o cabo deve ser desenrolado por completo).

8 Prima o botão de ligar/desligar.

**Atenção:** Certifique-se de que não há alimentos entre as placas.

PT

## 2 Primeira utilização

9 Escolha o seu idioma, utilizando as setas, depois prima Ok.



9

## 3 Ligar/desligar

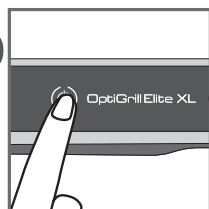

10

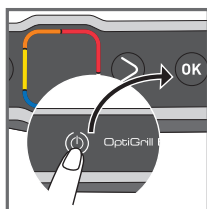

11

10 Ligar

11 Para desligar o grelhador, prima uma vez o botão de ligar/desligar e uma vez o botão Ok para desligar o aparelho.



## 4 Função Alimentos Congelados No modo automático

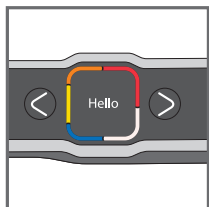

Olá

12



13

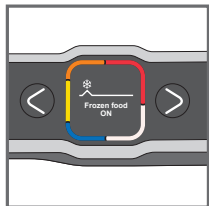

Função Congelados  
desligada

14

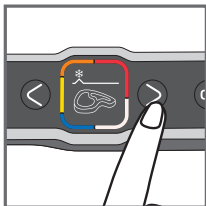

15

**13-15** Função de Alimentos congelados deverá ser ativada antes de iniciar o pré-aquecimento, durante a seleção do modo automático, se os alimentos a cozinhar estiverem congelados.

Caso se esqueça de ativar a opção, utilize o botão de retroceder e recomece os passos.

Esta função só está disponível no modo automático e não no modo manual.

PT

## 5 Função Selar - No modo automático

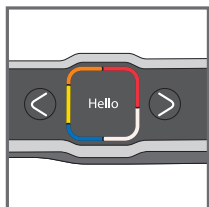

Olá

16



17

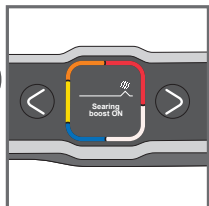

Função Selar Rápido  
ligada

18

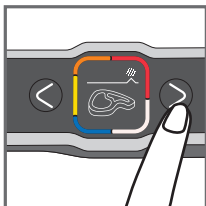

19

**17-19** Função Selar deverá ser ativada antes de iniciar o pré-aquecimento, durante a seleção do modo automático, se desejar selar mais intensamente alimentos a cozinhar.

Caso se esqueça de ativar esta opção, desligue o aparelho e repita os passos.

Esta função só está disponível no modo automático e não no modo manual.

## 6 Confeção no modo automático

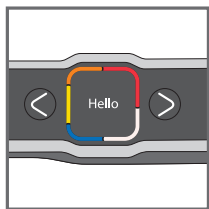

Olá  
20

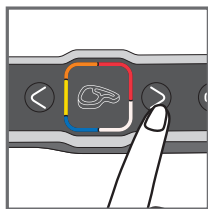

21

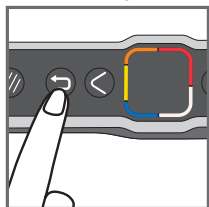

22

No caso de dúvidas acerca do modo de confeção a utilizar, consulte os guias de confeção na página 157.

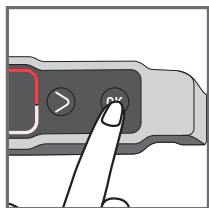

23



Pré- aquecimento em curso

24

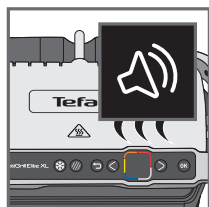

25

- 21 Seleccione o modo de confeção adequado de acordo com o tipo de alimento a cozinhar.

### Conselho relativamente à carne:

Os resultados de confeção dos programas predefinidos podem variar de acordo com a origem, o corte e a qualidade do alimento a cozinhar, tendo os programas sido definidos e testados com alimentos de boa qualidade.

De igual modo, a espessura da carne deve ser tida em conta durante a confeção. Não cozinhe alimentos com mais de 4 cm de espessura.

- 22 Se pretender mudar de programa, pode voltar ao menu principal premindo uma vez o botão de retroceder.

- 23 Prima o botão "OK": O aparelho começa o pré-aquecimento.

**Observação:** se seleccionar o programa errado, utilize o botão de retroceder.

- 24 Espere 4 a 7 minutos. Assim que o préaquecimento iniciar, se pretender alterar o programa seleccionado, prima o botão de retroceder e, em seguida, confirme com o botão OK para voltar ao menu principal. Ao premir uma segunda vez o botão de retroceder, irá anular a função.

- 25 É emitido um sinal sonoro para assinalar que o pré-aquecimento terminou.

**Comentário:** Se o aparelho permanecer fechado demasiado tempo após o pré-aquecimento terminar, o sistema de segurança desliga o aparelho.

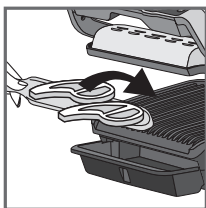
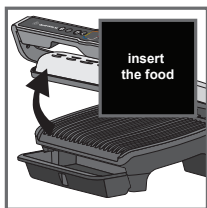

26-27

Quando o pré-aquecimento terminar, pode colocar os ingredientes. Levante a tampa do grelhador e coloque os alimentos sobre as placas.

**Comentário:** Se o aparelho permanecer aberto demasiado tempo, o sistema de segurança desliga o aparelho automaticamente.

**Coloque os seus alimentos**

26

27

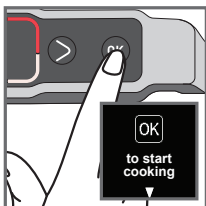
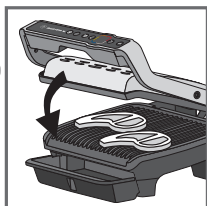

28-30

O aparelho calcula automaticamente o ciclo de confeção (tempo e temperatura), de acordo com a quantidade e espessura dos alimentos.

Feche o aparelho para iniciar o ciclo de confeção.

**Observação para os alimentos muito finos, por exemplo, bacon:**

O botão "OK" acende. Prima "OK" para garantir que o aparelho reconhece bem o alimento e para o ciclo de confeção começar.

**Para começar a confeção**

28

29



**Início da confeção**

30

31

A seta move-se ao longo do indicador do nível de confeção e quando atingir um nível de confeção, o nível é apresentado e será emitido um sinal sonoro.

Atenção: Os níveis de confeção estão pré-programados para cada modo automático.

Durante a confeção, um sinal sonoro avisa o utilizador sempre que um nível de confeção for atingido (por exemplo, mal passado / branca).

De acordo com o grau de confeção, o indicador muda de cor e a seta de progresso da confeção move-se pelo ecrã.

Tenha em conta que, especialmente para a carne, é normal os resultados de confeção variarem de acordo com o tipo, qualidade e origem dos alimentos.



32



Bem passado em 01:35

33

**32-33** Pode saber a qualquer momento o tempo restante para atingir os diferentes níveis de confeitão. Prima a seta da direita se desejar ver quanto tempo demora até que o nível de confeitão seguinte seja atingido. Atenção, não se trata de uma seleção de níveis de confeitão. O grelhador continua a cozinhar até ao último nível de confeitão e avisa quando chega a cada nível.

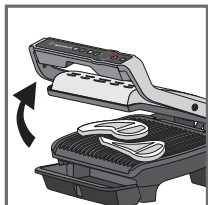

34

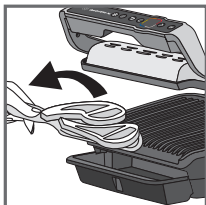

35

**34-35** Quando o nível de confeitão correspondente à sua escolha for atingido e for emitido um sinal sonoro, abra o aparelho e retire os alimentos.

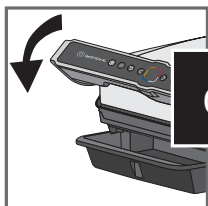

36



Para parar a confeitão

37

**36-37** Feche a tampa. O ecrã pede a confirmação para parar a confeitão. Valide com OK se todos os alimentos tiverem sido retirados, caso contrário, deixe continuar a confeitão.

Se desejar realizar uma nova confeitão, consulte o parágrafo 7.

**Comentário:** O sistema de segurança desliga automaticamente o aparelho se não for selecionado qualquer programa passado algum tempo.

PT

## 7 Como efetuar uma segunda confeitão

### Segunda confeitão do mesmo tipo de alimento

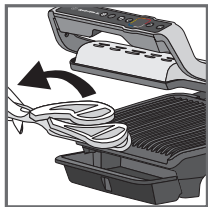

38

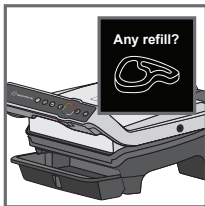

Grelhar novamente?

39

**38-39** No final da primeira confeitão, aparece a mensagem "nova confeitão". Se desejar grelhar o mesmo tipo de alimento, prima OK.

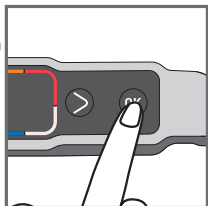

40



Pré-aquecimento em curso

41

**40** O aparelho começa o pré-aquecimento.

**41** Espere até ao final do pré-aquecimento.

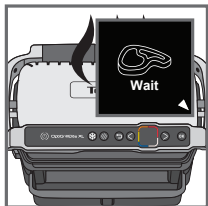

Aguarde

42

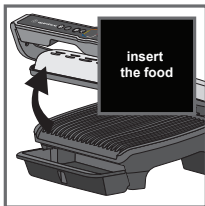

Coloque os seus alimentos

43

**42** Coloque os alimentos no grelhador.

**43** A seguir, siga os passos de 27 a 37.

### Segunda confeitão de um ingrediente diferente

Quando a confeitão dos primeiros ingredientes tiver terminado:

1. Certifique-se de que o aparelho está fechado e que não há alimentos no interior.
2. Selecione o modo ou o programa de confeitão adequado.
3. Prima o botão "OK" para começar o pré-aquecimento. Durante o pré-aquecimento, o indicador de pré-aquecimento aparece no ecrã.

- Quando o pré-aquecimento terminar, é emitido um sinal sonoro e a informação de final de pré-aquecimento aparece no ecrã.
- Quando o pré-aquecimento terminar, o aparelho está pronto a ser utilizado. Levante a tampa do grelhador e insira os alimentos. A seguir, siga os passos de 27 a 37.

### Importante:

– Tenha em conta que o pré-aquecimento é obrigatório para cada confeitura.

Nota: Antes de iniciar o pré-aquecimento, certifique-se de que o aparelho está fechado e que não há alimentos no interior.

– A seguir, espere que o pré-aquecimento termine antes de abrir o grelhador e de colocar os alimentos no interior.

**Observação:** Se o novo ciclo de pré-aquecimento for lançado imediatamente após o final do ciclo anterior, o tempo de pré-aquecimento será mais curto.

## 8 Confeitão no modo manual

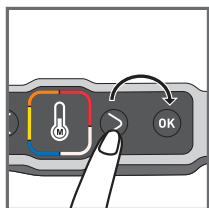

44

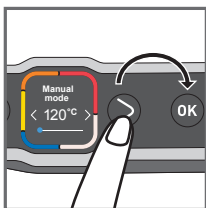

45

44 Selecione o modo manual e prima OK para validar.

45 Selecione a temperatura desejada com os botões de regulação. Prima OK para validar a temperatura selecionada.

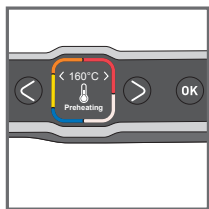

46

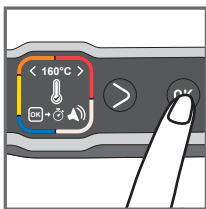

47

46 Espere até ao final do pré-aquecimento.

47 Quando o pré-aquecimento terminar, prima OK para iniciar o temporizador.

**Observação:** O tempo de confeitão também pode ser regulado desde o início do pré-aquecimento.

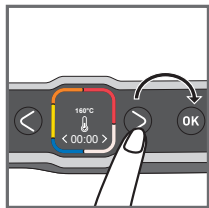

48

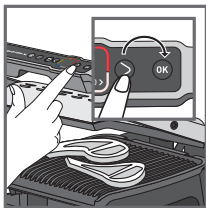

49

48 Prima os botões de regulação para selecionar o tempo de confeitão desejado.

49 Insira os alimentos e prima OK para iniciar a confeitão e o desconto do tempo.

Em qualquer altura, prima OK para regular a temperatura e/ou o tempo.

PT

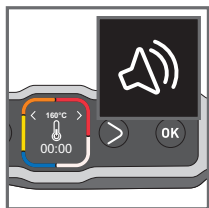

50

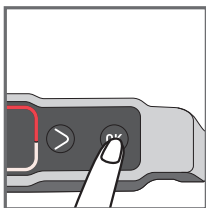

Para parar a confeção

51

**50-51** Um sinal sonoro indica quando o tempo de confeção terminar. Retire os seus alimentos.

caso se esqueça de ativar a opção, utilize o botão de retroceder e recomece os passos.

## 9 Comentários

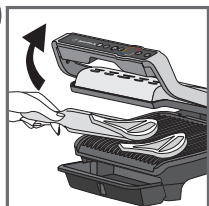

52

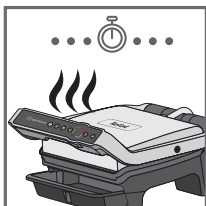

53

**52-54**

De acordo com as preferências pessoais, abra o grelhador e retire os alimentos que tenham atingido o nível de confeção desejado, depois volte a fechar o grelhador para continuar a confeção dos outros alimentos. O programa continua o ciclo de confeção até ao último nível de confeção do modo selecionado.



Retire os alimentos

54



Alimento demasiado cozinhado

55

**55 Comentário:** O sistema de segurança desliga automaticamente o aparelho passado algum tempo.



## 10 Fim de utilização

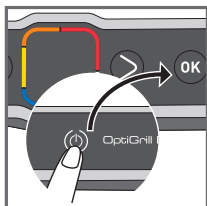

56

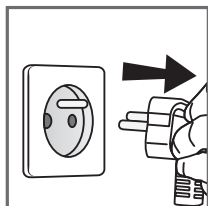

57

**56** Prima o botão de ligar/desligar e depois valide premindo o botão OK.

**57** Retire a ficha da tomada.

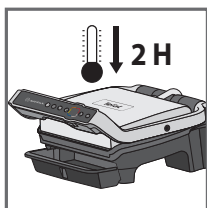

58

**58** Deixe o aparelho arrefecer durante, pelo menos, 2 horas.

Para evitar queimaduras acidentais, deixe o grelhador arrefecer por completo antes de proceder à sua limpeza.

PT

## 11 Limpeza

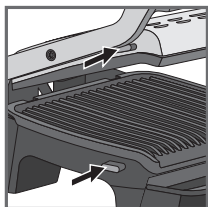

59

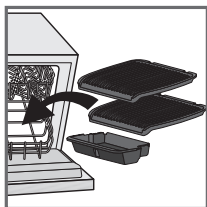

60

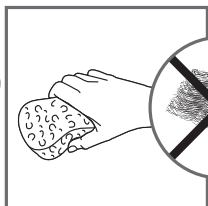

61

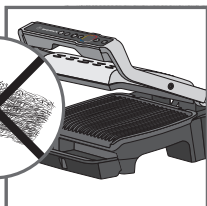

62

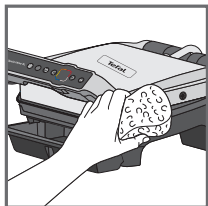

63



64

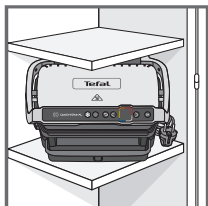

65

**59** Antes da limpeza, desbloqueie e retire as placas para evitar danificar a superfície de confeitação.

**60** O tabuleiro de recolha de sucos e as placas de confeitação podem ser lavadas na máquina de lavar loiça. O aparelho e o cabo nunca devem ir à máquina de lavar loiça. Os elementos de aquecimento (as resistências) nunca devem ser lavados quando as placas tiverem sido retiradas. Se estiverem muito sujos, espere que o aparelho arrefeça por completo e limpe-os com um pano seco.

**61-62**

Para facilitar a limpeza das placas, deixe-as imersas em água quente e detergente para a loiça durante uma hora e, em seguida, enxague com água abundante para eliminar quaisquer resíduos. Seque cuidadosamente com papel absorvente.

Não utilize esfregões metálicos, palha de aço ou produtos de limpeza abrasivos para limpar qualquer parte do grelhador. Utilize apenas esponjas de limpeza de nylon e que não sejam de metálicos.

Esvazie o tabuleiro de recolha de sucos e lave-o com água quente e um pouco de detergente. De seguida, seque cuidadosamente com um papel absorvente.

**63** Para limpar a tampa do grelhador, passe uma esponja humedecida em água quente e seque com um pano macio e seco. Para limpar o painel de comandos, utilize apenas um pano macio e seco.

**64** Não coloque o corpo do grelhador dentro de água ou de qualquer outro líquido.

**65** Certifique-se sempre de que o grelhador está limpo, frio e seco antes de o arrumar.

Qualquer reparação deve ser efetuada por um Serviço de Assistência Técnica autorizado.



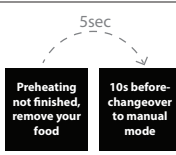

# Resolução de problemas

## GUIA DE RESOLUÇÃO DE PROBLEMAS ELITE

Problema	Causa	Solução
Mudança do idioma		Ligue o grelhador, prima ON e depois imediatamente no botão Frozen (Congelados) (enquanto o ecrã apresenta "Bom dia").
 <p>5sec</p> <p>Preheating not finished, remove your food</p> <p>10s before changeover to manual mode</p>	O tempo de pré-aquecimento não tinha terminado por completo. O grelhador foi aberto e os alimentos colocados na placa antes do final do pré-aquecimento.	Pode cozinhar os alimentos, mas deve controlar a confeção, pois o grelhador passou para o modo manual. A temperatura pode ser ajustada. Ou Abra o grelhador, retire os alimentos, feche corretamente o grelhador e espere até ao final do pré-aquecimento.
Não consigo desligar o meu aparelho.	Falta premir uma segunda vez, ou tempo demasiado longo entre as 2 pressões.	Prima uma vez o botão de ligar/desligar e depois valide premindo OK.
Err 1 a Err 8	O aparelho foi guardado ou utilizado numa divisão demasiado fria. Aparelho sobreaquecido.	Desligue o aparelho da corrente e espere alguns minutos. Volte a ligar o aparelho à corrente e coloque-o em funcionamento. Se o problema persistir, contacte o Centro de Contacto do Consumidor.
Err 9 a Err 13	Falha do aparelho.	Desligue o aparelho da corrente e contacte o Centro de Contacto do Consumidor
O aparelho desliga-se durante o ciclo de pré-aquecimento ou de confeção.	O aparelho esteve aberto durante demasiado tempo durante a confeção. O aparelho esteve parado demasiado tempo após o final do pré-aquecimento ou da opção de manter quente.	Desligue o aparelho da corrente e espere alguns minutos. A seguir, volte a ligá-lo à corrente e coloque-o em funcionamento.

pt

## GUIA DE RESOLUÇÃO DE PROBLEMAS ELITE

Problema	Causa	Solução
	Pedido de confirmação de final de confeção.	2 soluções: Prima OK se todos os alimentos tiverem sido retirados. Ou Não prima OK e deixe cozinhar o resto dos alimentos.
	Alimento não detetado, pois é demasiado fino.	Prima OK para iniciar a confeção.
	Alimento demasiado espesso.	2 soluções: Prima OK para continuar a confeção no modo manual. Ou Retire os alimentos para diminuir a espessura, de modo a permitir uma confeção no modo automático.
Não consigo regular um tempo no modo manual.	O ecrã permanece na regulação da temperatura.	Prima o botão OK para ir para a regulação do tempo, depois regule-o com as setas. Valide com OK.  

# Níveis de confeitão para cada programa automático

16 PROGRAMAS AUTOMÁTICOS					
PROGRAMAS AUTOMÁTICOS		INDICADOR DO NÍVEL DE CONFEIÇÃO			
MENUS					
	Vaca	Azul	Mal passado	Médio	Bem passado
	Frango	-	-	-	Bem passado
	Salsicha	-	-	-	Bem passado
	Bacon	-	-	Médio	Estaladiço
	Carne picada (hambúrguer)	-	Mal passado	Médio	Bem passado
	Panini	-	Ligeiramente cozinhado	Torrado	Estaladiço
	Peixe	-	Médio	No ponto extra	Bem passado
	Frutos do mar	-	Médio	No ponto extra	Bem passado
	Batata	-	-	-	Bem cozinhado
	Pimento	-	-	Estaladiço	Bem cozinhado
	Beringela	-	-	-	Grelhado
	Tomate	-	-	Estaladiço	Bem cozinhado
	Porco	-	-	No ponto extra	Bem passado
	Salsichas pré-cozinhadas	-	-	-	Bem cozinhado
	Borrego	-	Médio	No ponto extra	Bem passado
	Hambúrguer vegetariano	-	-	-	Bem cozinhado

PT

## CONSELHO DE CONFEÇÃO

PRODUTOS	PROGRAMA DE CONFEÇÃO	CONSELHO DE CONFEÇÃO
Lombo de porco (sem osso), barriga de porco		Bem passado*
Salsicha alemã (porco pré-cozido)		220 °C / 8 min 30
Salsicha de carne de vaca (vaca pré-cozida)		220 °C / 8 min 30
Salsicha de porco (porco pré-cozido)		220 °C / 4 min 30

## MODO MANUAL ESPECIAL

### LEGUME OU FRUTO

From 180°C to 195°C	From 220°C to 235°C	From 225°C to 270°C
-	-	Curgete rodelas
-	-	Espargos
-	-	Cogumelos
-	Cebola	-
Brócolos	-	-
Mini-cenoura	-	-
-	Funcho	-
Batata doce rodelas	-	-
-	Maçã (fatias)	-
-	Banana	-
-	Pêssego	-

## CONSELHO DE PREPARAÇÃO

Para grelhados bem selados, é preferível colocar novamente os alimentos no grelhador antes de os servir.

PRODUTOS	CONSELHO DE PREPARAÇÃO
BATATA	<ul style="list-style-type: none"><li>• Corte no sentido do comprimento</li><li>• Adicione óleo nos ingredientes para uma melhor confeção</li></ul>
PIMENTO	<ul style="list-style-type: none"><li>• Cortado ao meio no sentido do comprimento</li></ul>
BERINGELA	<ul style="list-style-type: none"><li>• Corte no sentido do comprimento</li><li>• Adicione óleo nos ingredientes para uma melhor confeção</li></ul>
TOMATE	<ul style="list-style-type: none"><li>• Utilize tomates redondos.</li><li>• Utilize tomates que não estejam demasiado maduros.</li><li>• Corte ao meio no sentido da largura.</li><li>• Para uma confeção ótima, coloque o lado arredondado do tomate cortado em 2 na placa inferior do grelhador.</li></ul>
PORCO	<ul style="list-style-type: none"><li>* Utilize a função selar se a espessura for superior a 20 mm.</li></ul>

# ΟΔΗΓΙΕΣ ΓΙΑ ΤΗΝ ΑΣΦΑΛΕΙΑ ΣΗΜΑΝΤΙΚΕΣ ΠΡΟΦΥΛΑΞΕΙΣ

**Χρήση, συντήρηση, καθαρισμός και εγκατάσταση του προϊόντος: για την ασφάλειά σας, ανατρέξτε στις επιμέρους παραγράφους αυτών των οδηγιών και στα αντίστοιχα εικονογράμματα.**

Η συσκευή αυτή προορίζεται αποκλειστικά για οικιακή χρήση. Δεν έχει σχεδιαστεί για χρήση στις ακόλουθες περιπτώσεις, οι οποίες δεν καλύπτονται από την εγγύηση:

- σε χώρους κουζίνας που χρησιμοποιούνται από το προσωπικό καταστημάτων, γραφείων και άλλων επαγγελματικών χώρων,

- σε αγροκτήματα,

- από τους πελάτες ξενοδοχείων, ξενώνων και λοιπών χώρων με χαρακτήρα φιλοξενίας,

- στα περιβάλλοντα τύπου δωματίων ξενοδοχείων.

Ε<sub>1</sub> Αφαιρέστε όλες τις συσκευασίες, τα αυτοκόλλητα ή τα διάφορα εξαρτήματα από το εσωτερικό και το εξωτερικό της συσκευής.

Η παρούσα συσκευή δεν προορίζεται προς χρήση από άτομα (συμπεριλαμβανομένων των παιδιών) των οποίων η σωματική, αισθητήρια ή πνευματική ικανότητα είναι μειωμένη, ή από άτομα χωρίς εμπειρία ή γνώση ως προς τη χρήση, εκτός εάν τα άτομα αυτά βρίσκονται υπό επίβλεψη ή ακολουθούν πρότερες οδηγίες που αφορούν στη χρήση της συσκευής από κάποιο πρόσωπο που είναι υπεύθυνο ως προς την ασφάλειά τους.

Τα παιδιά πρέπει να βρίσκονται υπό επίβλεψη προκειμένου να διασφαλιστεί ότι δεν θα παίζουν με τη συσκευή ούτε θα την χρησιμοποιήσουν ως παιχνίδι.

Μην αφήνετε ποτέ τη συσκευή χωρίς επίβλεψη.

 Η θερμοκρασία των προσβάσιμων επιφανειών μπορεί είναι υψηλή κατά την ώρα λειτουργίας της συσκευής.

Μην αγγίζετε τις θερμές επιφάνειες της συσκευής. Η συσκευή δεν έχει σχεδιαστεί για να τίθεται σε λειτουργία μέσω εξωτερικού χρονοδιακόπτη ή χωριστού συστήματος τηλεχειρισμού. Ξετυλίξτε εντελώς το καλώδιο.

Εάν το καλώδιο ρεύματος έχει φθαρεί, πρέπει να αντικατασταθεί από την κατασκευάστρια εταιρεία, το εξουσιοδοτημένο κέντρο εξυπηρέτησης μετά την πώληση της κατασκευάστριας εταιρείας ή έναν εξειδικευμένο τεχνικό για να αποφευχθεί κάθε κίνδυνος ατυχήματος.



Εάν χρησιμοποιείτε ηλεκτρική μπαλαντζέρα, η τάση της πρέπει να είναι τουλάχιστον ισοδύναμη με αυτήν της συσκευής και να διαθέτει ενσωματωμένη γειωμένη πρίζα. Λαμβάνετε όλες τις απαραίτητες προφυλάξεις, για να αποφύγετε τον κίνδυνο να σκοντάψει κάποιος στο καλώδιο. Συνδέετε τη συσκευή αποκλειστικά και μόνο σε πρίζα με γείωση. Ελέγξτε αν η ηλεκτρική εγκατάσταση είναι συμβατή με την ισχύ και την τάση που υποδεικνύονται κάτω από τη συσκευή.

Η παρούσα συσκευή δεν πρέπει να βυθίζεται σε νερό ή άλλο υγρό. Μην βυθίζετε ποτέ τη συσκευή και το καλώδιό της στο νερό.

Η συσκευή αυτή μπορεί να χρησιμοποιηθεί από παιδιά ηλικίας τουλάχιστον 8 ετών και από άτομα με μειωμένες σωματικές, αισθητηριακές ή νοητικές ικανότητες ή από άτομα που στερούνται εμπειρίας και γνώσεων, εφόσον εποπτεύονται ή έχουν λάβει σχετικές οδηγίες ως προς τη χρήση της συσκευής κατά τρόπο πλήρως ασφαλή και εφόσον κατανοούν τους κινδύνους που διατρέχουν. Ο καθαρισμός και η συντήρηση από τον χρήστη δεν πρέπει να πραγματοποιούνται από παιδιά, εκτός εάν είναι ηλικίας άνω των 8 ετών και τελούν υπό επίβλεψη. Φυλάξτε τη συσκευή και το καλώδιο σε θέση, η οποία δεν είναι προσβάσιμη σε παιδιά κάτω των 8 ετών.

**ΠΡΟΣΟΧΗ:** Μην ζεσταίνετε ή προθερμαίνετε τη σχάρα χωρίς τις 2 πλάκες στο εσωτερικό

## Τι να κάνετε

- Διαβάστε προσεκτικά τις οδηγίες χρήσεως και φυλάξτε τις σε ευπρόσιτο μέρος. Οι οδηγίες είναι κοινές για διάφορους τύπους, ανάλογα με τα εξαρτήματα που διαθέτει η συσκευή σας.
- Σε περίπτωση που προκληθεί κάποιο ατύχημα, ρίξτε αμέσως κρύο νερό στο έγκαυμα και συμβουλευθείτε έναν ιατρό εάν κριθεί απαραίτητο.
- Κατά την πρώτη χρήση, πλύνετε τις εστίες (βλέπε την παράγραφο 11), προσθέστε λίγο λάδι πάνω στις πλάκες και σκουπίστε τις με ένα μαλακό πανί.
- Φροντίστε για την σωστή τοποθέτηση του καλωδίου με ή χωρίς προέκταση, και πάρτε όλα τα απαραίτητα προστατευτικά μέτρα για να μην διαταράξετε την κυκλοφορία των παρευρισκομένων στο τραπέζι, ώστε κανείς να μην σκοντάψει.
- Οι ατμοί του ψησίματος ενδέχεται να είναι επικίνδυνοι για τα ζώα με ιδιαίτερα ευαίσθητο αναπνευστικό σύστημα, όπως τα πουλιά. Συνιστούμε στους ιδιοκτήτες πουλιών να τα απομακρύνουν από το χώρο ψησίματος.
- Κρατήστε τη συσκευή μακριά από τα παιδιά.
- Πριν από τη χρήση σιγουρευτείτε ότι οι δύο επιφάνειες της πλάκας έχουν καθαρίσει καλά.
- Για να αποφύγετε τη φθορά, να χρησιμοποιείτε τις πλάκες αποκλειστικά στη συσκευή για την οποία έχουν σχεδιαστεί (π.χ.: μην τις τοποθετείτε σε φούρνο, σε εστία αερίου ή σε ηλεκτρική εστία...).

- Προσέξτε οι πλάκες να είναι σταθερές και καλά τοποθετημένες και στερεωμένες στη βάση της συσκευής. Να χρησιμοποιείτε μόνο πλάκες που έχετε προμηθευτεί ή αγοράσει από το εξουσιοδοτημένο κέντρο επισκευής.
- Για να διατηρήσετε την επίστρωση των επιφανειών ψησίματος, να χρησιμοποιείτε πάντα μια πλαστική ή ξύλινη σπάτουλα.
- Να χρησιμοποιείτε μόνο τα εξαρτήματα που παρέχονται με τη συσκευή ή που αγοράζετε εξουσιοδοτημένο κέντρο επισκευής. Μην τις χρησιμοποιείτε με άλλες συσκευές.

## Τι να μην κάνετε

- Μην χρησιμοποιείτε τη συσκευή σε εξωτερικό χώρο.
- Μην αφήνετε ποτέ τη συσκευή συνδεδεμένη στο ρεύμα όταν δεν βρίσκεται σε χρήση.
- Για να αποφύγετε την υπερθέρμανση της συσκευής, μην την τοποθετείτε σε γωνία ή ακριβώς δίπλα στον τοίχο.
- Ποτέ μην τοποθετείτε τη συσκευή σας απευθείας επάνω σε ευπαθή επιφάνεια (γυάλινο τραπέζι, τραπεζομάντιλο, βερνικωμένο έπιπλο...) ή σε επιφάνεια που καλύπτεται από πλαστικό τραπεζομάντιλο.
- Μην τοποθετείτε ποτέ τη συσκευή κάτω από έπιπλο που έχετε στερεώσει σε τοίχο ή σε εταζέρα ή κοντά σε εύφλεκτα υλικά όπως στόρια, κουρτίνες, χρώματα.
- Μην τοποθετείτε τη συσκευή επάνω ή κοντά σε ολισθηρές ή καυτές επιφάνειες, μην αφήνετε το καλώδιο να κρέμεται πάνω από μία πηγή θερμότητας (πλάκες ψησίματος, εστία με άεριο κ.λπ.).
- Μην τοποθετείτε σκεύη μαγειρικής πάνω στις επιφάνειες μαγειρέματος της συσκευής.
- Μην κόβετε τροφές απευθείας πάνω στις πλάκες.
- Ποτέ μην χρησιμοποιείτε μεταλλικό σφουγγάρι ή σκόνη καθαρισμού, διότι μπορεί να προκληθεί φθορά στην επιφάνεια μαγειρέματος (π.χ.: στην αντικολητική επίστρωση).
- Μην μετακινείτε τη συσκευή όταν είναι σε λειτουργία.
- Μην μεταφέρετε τη συσκευή από τη λαβή ή τα μεταλλικά σύρματα.
- Ποτέ μην χρησιμοποιείτε τη συσκευή ενώ είναι άδεια.
- Μην τοποθετείτε ποτέ φύλλα αλουμινοχαρτού ή οποιοδήποτε άλλο αντικείμενο ανάμεσα στις πλάκες και τα τρόφιμα που θα ψήσετε.
- Μην αφαιρείτε το δίσκο συλλογής λιπών κατά το ψήσιμο. Εάν ο δίσκος συλλογής λιπών γεμίσει κατά το ψήσιμο, αφήστε τη συσκευή να κρυώσει προτού τον αδειάσετε.
- Μην βάζετε τη ζεστή πλάκα κάτω από νερό ή επάνω σε ευαίσθητη επιφάνεια.
- Για να διατηρήσετε τις αντικολητικές ιδιότητες της επίστρωσης, μην αφήνετε τη συσκευή να ζεσταίνεται για πολλή ώρα άδεια.
- Ποτέ μην χειρίζεστε τις πλάκες όταν είναι ζεστές.
- Μην ψήνετε τροφές που βρίσκονται μέσα σε χαρτί.
- Για να αποφύγετε τις φθορές στη συσκευή σας, μην εκτελείτε ποτέ συνταγές φλαμπέ σε αυτήν.
- Μην τοποθετείτε ποτέ φύλλα αλουμινοχαρτού ή οποιοδήποτε άλλο αντικείμενο ανάμεσα στις πλάκες και τις αντιστάσεις.
- Ποτέ μην ζεσταίνετε ή ψήνετε σε θέση «ανοιχτή σχάρα».
- Ποτέ μην ζεσταίνετε τη συσκευή χωρίς τις πλάκες ψησίματος.

## Συμβουλές/Πληροφορίες

- Ευχαριστούμε που αγοράσατε αυτή τη συσκευή, η οποία έχει κατασκευαστεί για οικιακή χρήση μόνο.
- Για την ασφάλειά σας, η συσκευή αυτή συμμορφώνεται προς τα ισχύοντα πρότυπα και κανονισμούς (Οδηγίες περί χαμηλής τάσης, ηλεκτρομαγνητικής συμβατότητας, υλικών σε επαφή με τρόφιμα, περιβάλλοντος...).
- Κατά την πρώτη χρήση, η συσκευή μπορεί να παράγει μια ελαφριά μυρωδιά ή λίγο ατμό.
- Για να καθαρίσετε τις πλάκες ψησίματος, χρησιμοποιήστε ένα σφουγγάρι, ζεστό νερό και υγρό πιάτων.
- Η εταιρεία μας διατηρεί το δικαίωμα να τροποποιήσει ανά πάσα στιγμή, για το συμφέρον του καταναλωτή, τα χαρακτηριστικά ή τα μέρη από τα οποία αποτελούνται τα προϊόντα της.
- Καμία υγρή ή στερεά τροφή η οποία έρχεται σε επαφή με τα εξαρτήματα που φέρουν το λογότυπο  δεν μπορεί να καταναλωθεί.
- Εάν τα τρόφιμα έχουν υπερβολικά μεγάλο πάχος, το σύστημα ασφάλειας απαγορεύει τη θέση της συσκευής σε λειτουργία.
- Η αντίσταση δεν καθαρίζεται. Εάν είναι πολύ βρώμικη, περιμένετε μέχρι να κρυώσει εντελώς και σκουπίστε τη με ένα στεγνό πανί.
- Ο πίνακας ελέγχου είναι ευαίσθητο εξάρτημα: πρέπει να καθαρίζεται, να σκουπίζεται και να στεγνώνεται μόνο με ένα στεγνό και μαλακό πανί. Μη χρησιμοποιείτε βρεγμένο σφουγγάρι, διότι μπορεί να υποστούν βλάβη οι λειτουργίες του.

## Περιβάλλον



### Ας συμβάλουμε στην προστασία του περιβάλλοντος!

- ① Η συσκευή σας περιέχει αρκετά αξιοποιήσιμα ή ανακυκλώσιμα υλικά.
- ➔ Παραδώστε την παλιά σας συσκευή σε ένα κέντρο συλλογής ή, ελλείψει αυτού, σε ένα εξουσιοδοτημένο κέντρο επισκευής για την επεξεργασία της.

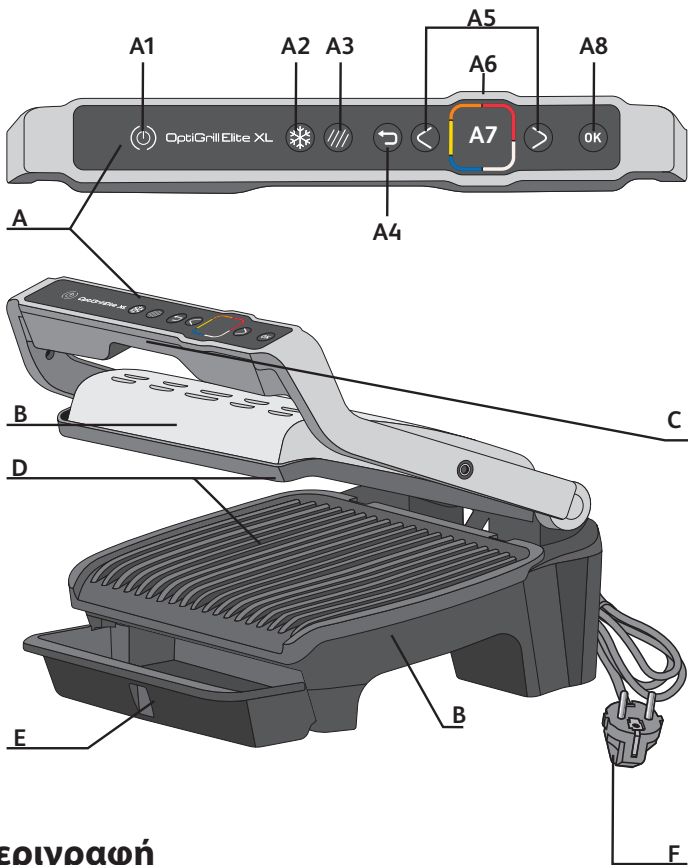

## Περιγραφή

**A** Πίνακας ελέγχου

**A1** Κουμπί ενεργοποίησης/ απενεργοποίησης (ON/ OFF)

**A2** Λειτουργία απόψυξης

**A3** Λειτουργία θωράκισης

**A4** Κουμπί επιστροφής

**A5** Κουμπιά ρύθμισης και πλοήγησης

**A6** Ένδειξη προθέρμανσης και βαθμού ψησίματος

**A7** Οθόνη ενδείξεων

**A8** Κουμπί OK

**B** Σώμα συσκευής

**C** Χειρολαβή

**D** Πλάκες ψησίματος

**E** Δίσκος περισυλλογής υγρών

**F** Ηλεκτρικό καλώδιο

Τα κουμπιά είναι ενεργοποιημένα μόνο όταν είναι αναμμένα.

# 16 αυτόματα προγράμματα ψησίματος

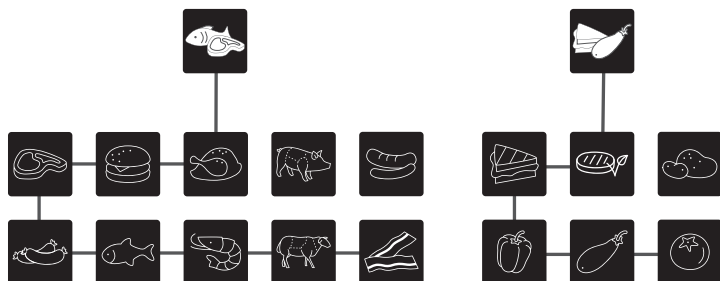

## Δύο επιλογές ψησίματος στην αυτόματη λειτουργία



Λειτουργία απόψυξης



Λειτουργία θωράκισης

## Χειροκίνητη λειτουργία

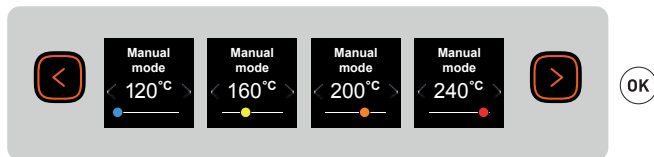

## Ένα κουμπί επιστροφής



Αν έχετε εισέλθει σε ένα υπομενού και θέλετε να επιστρέψετε στο κύριο μενού, πατήστε μία φορά το κουμπί επιστροφής.

Αν έχετε επιλέξει λάθος πρόγραμμα, πατήστε δύο φορές το κουμπί επιστροφής για να ακυρώσετε τη λειτουργία.

# 1 Προετοιμασία

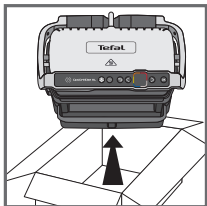
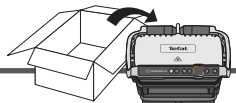

1

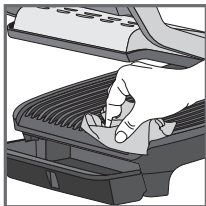

2

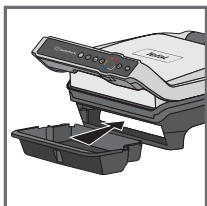

3



OK

4

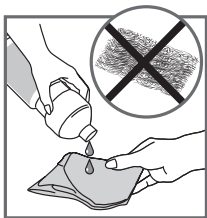

5



6

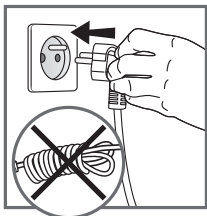

7

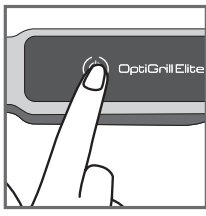

8

1 Αφαιρέστε όλα τα υλικά συσκευασίας, τα αυτοκόλλητα και τα διάφορα βοηθητικά εξαρτήματα εσωτερικά και εξωτερικά της συσκευής.

2 Πριν από την πρώτη χρήση, καθαρίστε καλά τις πλάκες με ζεστό νερό και υγρό πιάτων, ξεπλύνετε και σκουπίστε καλά.

3-4 Τοποθετήστε τον αφαιρούμενο δίσκο περισυλλογής υγρών στο μπροστινό μέρος της συσκευής.

5 Για καλύτερα αποτελέσματα και για να είναι πιο αποτελεσματική η αντικολλητική επιστρώση, μπορείτε αν θέλετε να περάσετε τις πλάκες ψησίματος με χαρτί κουζίνας εμποτισμένο με λίγο μαγειρικό λάδι.

6 Σκουπίστε την περίσσεια λαδιού με καθαρό χαρτί κουζίνας.

7 Βεβαιωθείτε ότι έχετε τοποθετήσει σωστά την πάνω και την κάτω πλάκα στο προϊόν. Μην προθερμαίνετε τη συσκευή χωρίς τις πλάκες. Συνδέστε τη συσκευή στο ρεύμα. (Το καλώδιο πρέπει να είναι ξετυλιγμένο τελείως).

8 Πατήστε το κουμπί ON/OFF.

**Προσοχή:** Βεβαιωθείτε ότι δεν υπάρχουν τρόφιμα ανάμεσα στις πλάκες.

## 2 Πρώτη χρήση

9 Επιλέξτε γλώσσα με τα βέλη και μετά πατήστε OK.



9

## 3 Ενεργοποίηση/Απενεργοποίηση



10

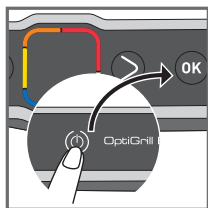

11

10 Ενεργοποιήστε τη συσκευή.

11 Πατήστε το κουμπί ON/OFF και μετά επιβεβαιώστε, πατώντας το κουμπί OK.

## 4 Λειτουργία απόψυξης - στην αυτόματη λειτουργία

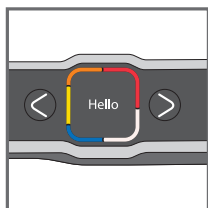

Γεια σας

12



13

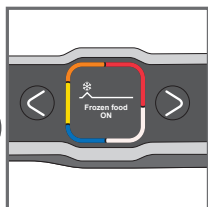

Κατεψυγμένα ΑΠΕΝ

14

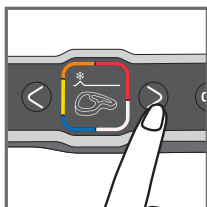

15

**13-15** Η λειτουργία απόψυξης πρέπει να ενεργοποιείται πριν από την προθέρμανση, όταν επιλέγεται η αυτόματη λειτουργία, αν τα τρόφιμα που θα ψήσετε είναι κατεψυγμένα.

Αν ξεχάσετε να ενεργοποιήσετε την επιλογή, χρησιμοποιήστε το κουμπί επιστροφής και επαναλάβετε τα βήματα.

Αυτή η επιλογή είναι διαθέσιμη μόνο στην αυτόματη λειτουργία, όχι στη χειροκίνητη.



## 5 Λειτουργία θωράκισης - στην αυτόματη λειτουργία

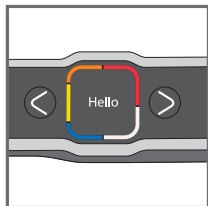

Γεια σας

16



17

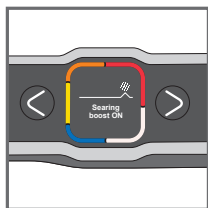

Πιπεριά

18

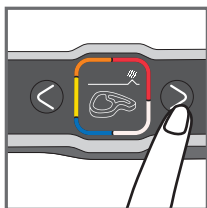

19

**17-19** Η λειτουργία θωράκισης πρέπει να ενεργοποιείται πριν από την προθέρμανση, όταν επιλέγεται η αυτόματη λειτουργία, αν θέλετε να θωρακίσετε τα τρόφιμα που θα ψήσετε.

Αν ξεχάσετε να ενεργοποιήσετε την επιλογή, σβήστε τη συσκευή και επαναλάβετε τα βήματα.

Αυτή η επιλογή είναι διαθέσιμη μόνο στην αυτόματη λειτουργία, όχι στη χειροκίνητη.

ΕΛ

## 6 Ψήσιμο στην αυτόματη λειτουργία

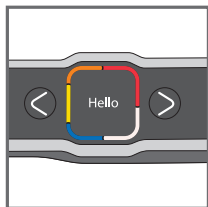

Γεια σας  
20

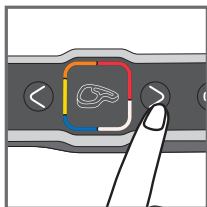

21

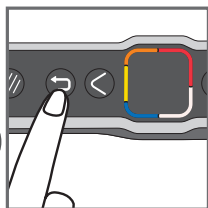

22

Αν δεν ξέρετε ποιο πρόγραμμα ψησίματος να χρησιμοποιήσετε, ανατρέξτε στον οδηγό ψησίματος στη σελίδα 180.

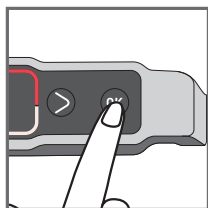

23



Προθέρμανση σε εξέλιξη

24

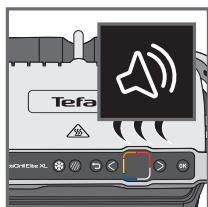

25

21 Επιλέξτε το κατάλληλο πρόγραμμα ψησίματος ανάλογα με το είδος του τροφίμου.

**Συμβουλή, κυρίως για το κρέας:** το αποτέλεσμα του ψησίματος στα προκαθορισμένα προγράμματα μπορεί να διαφέρει ανάλογα με την προέλευση, το κομμάτι και την ποιότητα του τροφίμου. Τα προγράμματα έχουν διαμορφωθεί και δοκιμαστεί με τρόφιμα καλής ποιότητας.

Επίσης, για το ψήσιμο, θα πρέπει να λαμβάνετε υπόψη και πόσο χοντρό είναι το κομμάτι κρέατος. Μην ψήνετε τρόφιμα με πάχος μεγαλύτερο από 4 cm.

22 Αν θέλετε να αλλάξετε πρόγραμμα, μπορείτε να επιστρέψετε στο κύριο μενού πατώντας μία φορά το κουμπί επιστροφής.

23 Πατήστε το κουμπί «OK»: η συσκευή θα αρχίσει να προθερμαίνεται.

**Σημείωση:** αν επιλέξετε κάποιο πρόγραμμα κατά λάθος, χρησιμοποιήστε το κουμπί επιστροφής.

24 Περιμένετε 4 με 7 λεπτά. Μόλις ξεκινήσει η προθέρμανση, αν επιθυμείτε να αλλάξετε το επιλεγμένο πρόγραμμα, πατήστε το κουμπί επιστροφής και μετά επικυρώστε την επιλογή με το κουμπί OK για να επιστρέψετε στο κύριο μενού. Με ένα δεύτερο πάτημα στο κουμπί επιστροφής μπορείτε να ακυρώσετε τη λειτουργία.

25 Μόλις ολοκληρωθεί η προθέρμανση, θα ακουστεί ένας ήχος.

**Σημείωση:** αν η συσκευή μείνει κλειστή πολλή ώρα αφού ολοκληρωθεί η προθέρμανση, το σύστημα ασφαλείας θα απενεργοποιήσει τη συσκευή.

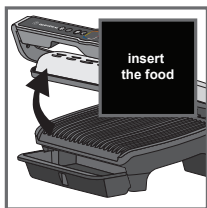

Τοποθετήστε τα τρόφιμα

26

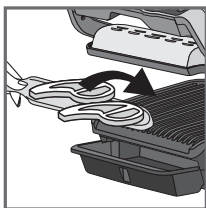

27

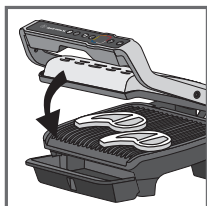

28

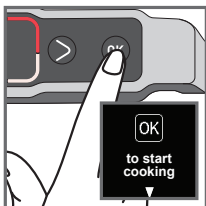

για έναρξη ψησίματος

29



Έναρξη ψησίματος

30

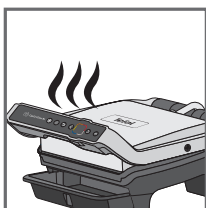

31

26-27

Μόλις τελειώσει η προθέρμανση, μπορείτε να τοποθετήσετε τα τρόφιμα. Σηκώστε το καπάκι της ψηστήρας και τοποθετήστε τα τρόφιμα στην πλάκα.

**Σημείωση:** αν η συσκευή μείνει ανοικτή πολλή ώρα, το σύστημα ασφαλείας θα απενεργοποιήσει αυτόματα τη συσκευή.

28-30

Η συσκευή θα υπολογίσει αυτόματα τον κύκλο ψησίματος (χρόνος και θερμοκρασία) ανάλογα με την ποσότητα των υλικών και πόσο χοντρά είναι τα κομμάτια.

Κλείστε τη συσκευή για να ξεκινήσει ο κύκλος ψησίματος.

**Σημείωση για πολύ λεπτά τρόφιμα, όπως είναι το μπέικον:**

Θα ανάψει το κουμπί «OK». Πατήστε το «OK» για να αναγνωρίσει η συσκευή το τρόφιμο και να ξεκινήσει ο κύκλος ψησίματος.

Το βέλος μετατοπίζεται κατά μήκος της ένδειξης βαθμού ψησίματος, και μόλις επιτυγχάνεται κάθε επιμέρους βαθμός ψησίματος, εμφανίζεται η αντίστοιχη ένδειξη και ακούγεται ένας ήχος.

Σημείωση: οι βαθμοί ψησίματος είναι προκαθορισμένοι για κάθε αυτόματο πρόγραμμα.

Στη διάρκεια του ψησίματος, κάθε φορά που επιτυγχάνεται ένας βαθμός ψησίματος, ακούγεται ένας ήχος (π.χ., σενιάν/ξεροψημένο).

Η ένδειξη αλλάζει χρώμα ανάλογα με τον βαθμό ψησίματος και το βέλος προόδου ψησίματος μετατοπίζεται στην οθόνη.

Σημειώστε ότι, ειδικά για το κρέας, το αποτέλεσμα του ψησίματος είναι φυσιολογικό να διαφέρει ανάλογα με το είδος, την ποιότητα και την προέλευση του τροφίμου.



32



Καλοψημένο σε 01:35

33

**32-33** Μπορείτε να δείτε ανά πάσα στιγμή τον χρόνο που απομένει μέχρι να επιτευχθούν οι διάφοροι βαθμοί ψησίματος. Πατήστε το δεξιό βέλος για να δείτε σε πόσο χρόνο θα επιτευχθεί ο επόμενος βαθμός ψησίματος. Προσοχή, με αυτόν τον τρόπο δεν επιλέγετε βαθμό ψησίματος. Η ψηστιέρα θα συνεχίσει να ψήνει μέχρι τον τελευταίο βαθμό ψησίματος και θα σας ειδοποιεί σε κάθε βαθμό.

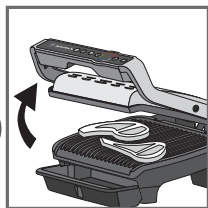

34

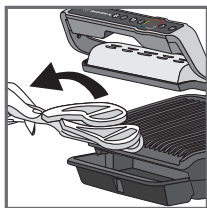

35

**34-35** Μόλις εμφανιστεί η επιθυμητή ένδειξη βαθμού ψησίματος και ακουστεί ο ήχος, ανοίξτε τη συσκευή και αφαιρέστε τα τρόφιμα.

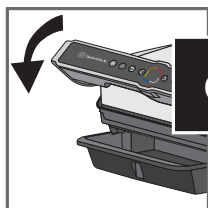

36



37

για διακοπή ψησίματος

**36-37** Κλείστε το καπάκι. Η οθόνη θα σας ζητήσει να επιβεβαιώσετε ότι θέλετε να σταματήσει το ψήσιμο. Πατήστε OK, αν έχετε αφαιρέσει όλα τα τρόφιμα, αλλιώς αφήστε να συνεχιστεί το ψήσιμο.

Αν θέλετε να ψήσετε κι άλλα υλικά, ανατρέξτε στην παράγραφο 7.

**Σημείωση:** το σύστημα ασφαλείας θα απενεργοποιήσει αυτόματα τη συσκευή, αν δεν επιλέξετε κανένα πρόγραμμα μετά από ορισμένο χρόνο.

## 7 Πώς να ψήσετε δεύτερη δόση

Δεύτερο ψήσιμο με το ίδιο είδος τροφίμου

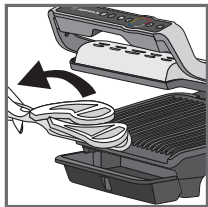

38



Θα ψήσετε κι άλλα;

39

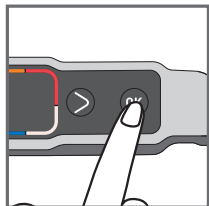

40



Προθέρμανση σε εξέλιξη

41

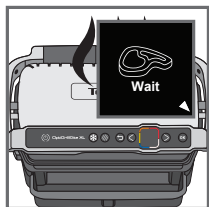

Περιμένετε

42

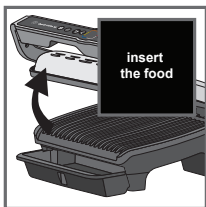

Τοποθετήστε τα τρόφιμα

43

**38-39** Μόλις τελειώσει το πρώτο ψήσιμο, στην οθόνη θα εμφανιστεί η ένδειξη «Θα ψήσετε κι άλλα». Αν θέλετε να ψήσετε το ίδιο είδος τροφίμου, πατήστε OK.

**40** Η συσκευή θα αρχίσει να προθερμαίνεται.

**41** Περιμένετε να ολοκληρωθεί η προθέρμανση.

**42** Τοποθετήστε τα τρόφιμα στην ψηστήρα.

**43** Μετά, ακολουθήστε τα βήματα 27 έως 37.

### Δεύτερο ψήσιμο με διαφορετικό υλικό

Αφού ψήσετε τα πρώτα υλικά σας:

1. Βεβαιωθείτε ότι η συσκευή είναι κλειστή και ότι δεν έχει μέσα τρόφιμα.
2. Επιλέξτε την επιθυμητή λειτουργία ή το επιθυμητό πρόγραμμα.
3. Πατήστε το κουμπί «OK» για να ξεκινήσει η προθέρμανση. Στην οθόνη θα εμφανίζεται η ένδειξη προθέρμανσης.
4. Μόλις τελειώσει η προθέρμανση, θα ακουστεί ο ήχος και στην οθόνη θα εμφανιστεί η ένδειξη τέλους προθέρμανσης.

5. Η συσκευή είναι έτοιμη να χρησιμοποιηθεί μόλις τελειώσει η προθέρμανση. Σηκώστε το καπάκι της ψηστιέρας και τοποθετήστε τα τρόφιμα μέσα στη συσκευή. Μετά, ακολουθήστε τα βήματα 27 έως 37.

### Σημαντικό:

– Σημειώστε ότι πρέπει να γίνεται προθέρμανση σε κάθε ψήσιμο.

Υπενθύμιση: πριν ξεκινήσετε την προθέρμανση, βεβαιωθείτε ότι η συσκευή είναι κλειστή και ότι δεν έχει μέσα τρόφιμα.

– Μετά, περιμένετε να τελειώσει η προθέρμανση και ύστερα ανοίξετε την ψηστιέρα και τοποθετήστε τα υλικά.

**Σημείωση:** αν ο νέος κύκλος προθέρμανσης ξεκινήσει αμέσως μόλις τελειώσει ο προηγούμενος κύκλος, ο χρόνος προθέρμανσης θα είναι μικρότερος.

## 8 Ψήσιμο στη χειροκίνητη λειτουργία

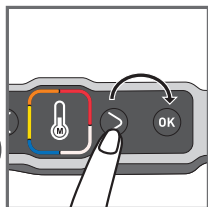

44

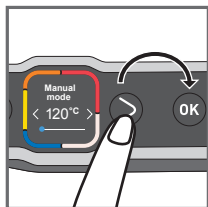

45

44 Επιλέξτε τη χειροκίνητη λειτουργία και πατήστε OK για επιβεβαίωση.

45 Επιλέξτε την επιθυμητή θερμοκρασία με τα κουμπιά ρύθμισης. Πατήστε OK για να επιβεβαιώσετε την επιλεγμένη θερμοκρασία.

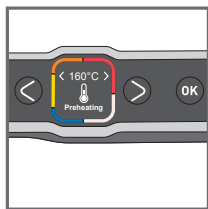

46

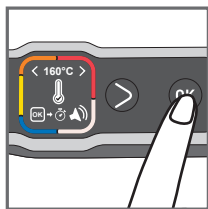

47

46 Περιμένετε να ολοκληρωθεί η προθέρμανση.

47 Μόλις τελειώσει η προθέρμανση, πατήστε OK για να ξεκινήσει το χρονομέτρο.

**Σημείωση:** μπορείτε να ρυθμίσετε τον χρόνο ψησίματος και στην αρχή της προθέρμανσης.

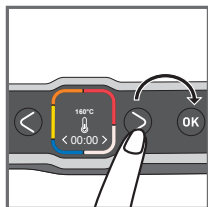

48

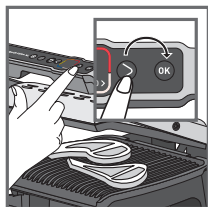

49

48 Επιλέξτε τον επιθυμητό χρόνο ψησίματος με τα κουμπιά ρύθμισης.

49 Τοποθετήστε τα τρόφιμα και πατήστε OK για να ξεκινήσει το ψήσιμο και η χρονομέτρηση.

Μπορείτε να πατήσετε το κουμπί OK για να ρυθμίσετε τη θερμοκρασία ή/και τον χρόνο οποιαδήποτε στιγμή.

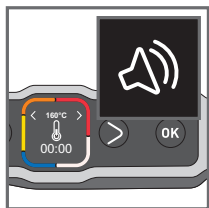

50

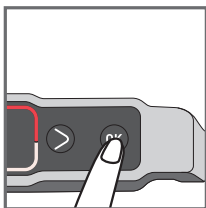

για διακοπή ψησίματος

51

**50-51** Μόλις ολοκληρωθεί ο χρόνος ψησίματος, θα ακουστεί ένας ήχος. Αφαιρέστε τα τρόφιμα.

Πατήστε OK για να σταματήσει το ηχητικό σήμα και αφαιρέστε τα τρόφιμα.

## 9 Σημειώσεις

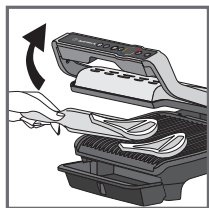

52



53

**52-54**

Μπορείτε να ανοίξετε την ψηστήρα και να αφαιρέσετε τα τρόφιμα που ψηθεί στον βαθμό που θέλετε, και μετά να ξανακλείσετε την ψηστήρα για να συνεχίσουν να ψήνονται τα υπόλοιπα τρόφιμα. Το πρόγραμμα θα συνεχίσει τον κύκλο μέχρι τον τελευταίο βαθμό ψησίματος για το επιλεγμένο πρόγραμμα.



Αφαιρέστε τα τρόφιμα

54



Κίνδυνος να παραψηθεί

55

**55 Σημείωση:** το σύστημα ασφαλείας θα απενεργοποιήσει αυτόματα τη συσκευή μετά από ορισμένο χρόνο.

## 10 Τερματισμός λειτουργίας

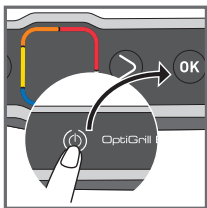

56

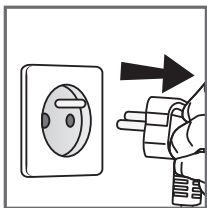

57

**56** Πατήστε το κουμπί ON/OFF και μετά επιβεβαιώστε, πατώντας το κουμπί OK.

**57** Αποσυνδέστε τη συσκευή από την πρίζα.

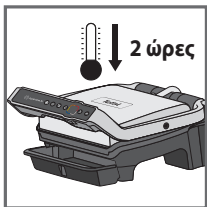

58

**58** Αφήστε να κρυώσει τουλάχιστον 2 ώρες.

Για να αποφύγετε τον κίνδυνο εγκαύματος, αφήστε την ψηστήρα να κρυώσει τελείως πριν την καθαρίσετε.



## 11 Καθαρισμός

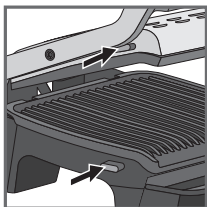

59

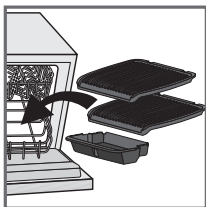

60

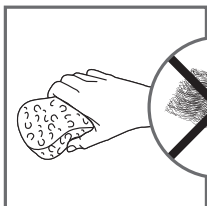

61

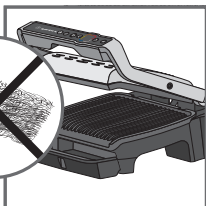

62

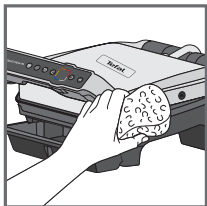

63



64

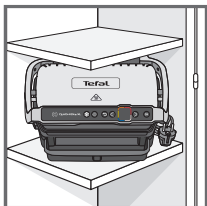

65

**59** Πριν από τον καθαρισμό, απασφαλίστε και αφαιρέστε τις πλάκες για να μην καταστραφεί η επιφάνεια ψησίματος.

**60** Ο δίσκος περισυλλογής υγρών και οι πλάκες ψησίματος πλένονται στο πλυντήριο πιάτων. Μην τοποθετήσετε ποτέ τη συσκευή και το καλώδιο στο πλυντήριο πιάτων. Μην πλένετε ποτέ τα θερμαντικά στοιχεία (τις αντιστάσεις) αφού αφαιρέσετε τις πλάκες. Αν έχουν λερωθεί, περιμένετε να κρυώσει τελείως η συσκευή και καθαρίστε τις με ένα στεγνό πανί.

**61-62** Για να καθαρίσετε πιο εύκολα τις πλάκες, μπορείτε να τις αφήσετε να μουλιάσουν για 1 ώρα μέσα σε ζεστό νερό με υγρό πιάτων και μετά να τις ξεπλύνετε καλά για να απομακρυνθούν όλα τα υπολείμματα. Σκουπίστε καλά με χαρτί κουζίνας. Μην καθαρίζετε κανένα μέρος της ψηστιέρας, σύμφωνα ή διαβρωτικά καθαριστικά. Χρησιμοποιήστε μόνο νάιλον ή μη μεταλλικά σφουγγάρια. Αδειάστε τον δίσκο περισυλλογής και πλύνετε με ζεστό νερό και λίγο υγρό πιάτων. Μετά, σκουπίστε καλά με χαρτί κουζίνας.



**63** Για να καθαρίσετε το καπάκι της ψηστιέρας, περάστε το με ένα σφουγγάρι εμποτισμένο με ζεστό νερό και σκουπίστε με ένα στεγνό μαλακό πανί. Για να καθαρίσετε τον πίνακα ελέγχου, χρησιμοποιήστε μόνο ένα μαλακό και στεγνό πανί.

**64** Μη βυθίζετε το σώμα της ψηστιέρας σε νερό ή άλλο υγρό.

**65** Η ψηστιέρα πρέπει να είναι πάντα καθαρή, κρύα και στεγνή πριν την αποθηκεύσετε. Κάθε άλλη εργασία επισκευής θα πρέπει να πραγματοποιείται από εξουσιοδοτημένο αντιπρόσωπο σέρβις.

# Επίλυση προβλημάτων

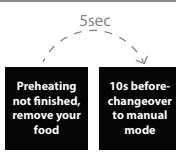
## ΕΠΙΛΥΣΗ ΠΡΟΒΛΗΜΑΤΩΝ ELITE

Πρόβλημα	Αιτία	Επίλυση
Αλλαγή γλώσσας		Συνδέστε την ψηστιέρα στην πρίζα, πατήστε το ON και αμέσως μετά το κουμπί απόψυξης (όσο στην οθόνη εμφανίζεται η ένδειξη «Γεια σας»).
 <p>5sec</p> <p>Preheating not finished, remove your food</p> <p>10s before-changeover to manual mode</p>	Δεν ολοκληρώθηκε ο χρόνος προθέρμανσης. Άνοιξε η ψηστιέρα και τοποθετήθηκαν τρόφιμα στην πλάκα πριν ολοκληρωθεί η προθέρμανση.	Μπορείτε να ψήσετε τα τρόφιμα, αλλά θα πρέπει να ελέγχετε το ψήσιμο γιατί η ψηστιέρα έχει περάσει στη χειροκίνητη λειτουργία. Μπορείτε να ρυθμίσετε τη θερμοκρασία. Ή Ανοίξετε την ψηστιέρα, αφαιρέστε τα τρόφιμα, κλείστε σωστά την ψηστιέρα και περιμένετε να ολοκληρωθεί η προθέρμανση.
 Δεν μπορώ να σβήσω τη συσκευή.	Δεν πατήθηκε το κουμπί δεύτερη φορά, ή πέρασε πολύς χρόνος ανάμεσα στα 2 πατήματα.	Πατήστε μία φορά το κουμπί ON/OFF και μετά επιβεβαιώστε με το OK.
Σφάλμα 1 έως 8	Η συσκευή είχε αποθηκευτεί ή χρησιμοποιείται σε πολύ ψυχρό χώρο. Η συσκευή έχει υπερθερμανθεί.	Βγάλτε τη συσκευή από την πρίζα και περιμένετε μερικά λεπτά. Συνδέστε ξανά τη συσκευή στην πρίζα και πατήστε το κουμπί ON. Αν το πρόβλημα παραμένει, απευθυνθείτε στην εξυπηρέτηση πελατών.
Σφάλμα 9 έως 13	Βλάβη της συσκευής.	Βγάλτε τη συσκευή από την πρίζα και απευθυνθείτε στην εξυπηρέτηση πελατών.
Η συσκευή σταματά από μόνη της κατά την προθέρμανση ή το ψήσιμο.	Η συσκευή έμεινε ανοικτή πολλή ώρα κατά το ψήσιμο. Η συσκευή έμεινε ανενεργή πολλή ώρα αφού τελείωσε η προθέρμανση.	Αποσυνδέστε τη συσκευή από την πρίζα και περιμένετε μερικά λεπτά. Μετά, συνδέστε ξανά τη συσκευή στην πρίζα και ενεργοποιήστε την.

## ΕΠΙΛΥΣΗ ΠΡΟΒΛΗΜΑΤΩΝ ELITE



Πρόβλημα	Αιτία	Επίλυση
	Μήνυμα επιβεβαίωσης για διακοπή ψήσιματος	2 λύσεις: Πατήστε OK, αν έχετε αφαιρέσει όλα τα τρόφιμα. Ή Μην πατήσετε OK και αφήστε να ψηθούν και τα υπόλοιπα τρόφιμα.
	Το υλικό δεν αναγνωρίζεται γιατί είναι πολύ λεπτό.	Πατήστε OK για να ξεκινήσει το ψήσιμο.
	Το υλικό είναι πολύ χοντρό.	2 λύσεις: Πατήστε OK για να συνεχίσετε το ψήσιμο στη χειροκίνητη λειτουργία. Ή Αφαιρέστε τα τρόφιμα και κόψτε τα λεπτότερα, για να μπορείτε να τα ψήσετε αυτόματα.
Δεν μπορώ να ρυθμίσω τον χρόνο στη χειροκίνητη λειτουργία.	Η οθόνη έχει μείνει στη ρύθμιση θερμοκρασίας.	Πατήστε μία φορά το OK για να περάσετε στη ρύθμιση του χρόνου και χρησιμοποιήστε τα βέλη για να ορίσετε την επιθυμητή διάρκεια. Επιβεβαιώστε με το OK. <div style="text-align: center; margin-top: 10px;">  </div>

# Βαθμοί ψησίματος αυτόματων προγραμμάτων

## 16 ΑΥΤΟΜΑΤΑ ΠΡΟΓΡΑΜΜΑΤΑ

ΑΥΤΟΜΑΤΑ ΠΡΟΓΡΑΜΜΑΤΑ		ΕΝΔΕΙΞΗ ΒΑΘΜΟΥ ΨΗΣΙΜΑΤΟΣ			
ΜΕΝΟΥ		 Blue	 Rare	 Medium	 Well-done
	Μοσχάρι	Ωμό	Σενιάν	Μέτριο	Καλοψημένο
	Στήθος κοτόπουλο	-	-	-	Καλοψημένο
	Λουκάνικο	-	-	-	Καλοψημένο
	Μπέικον	-	-	Μέτριο	Ξεροψημένο
	Μπιφτέκι	-	Σενιάν	Μέτριο	Καλοψημένο
	Σάντουιτς	-	Ελαφρώς ψημένο	Καλοψημένο	Ξεροψημένο
	Ψάρι	-	Μέτριο	Μέτριο προς καλοψημένο	Καλοψημένο
	Θαλασσινά	-	Μέτριο	Μέτριο προς καλοψημένο	Καλοψημένο
	Πατάτα	-	-	-	Μαλακό
	Πιπεριά	-	-	Μαλακό καλοψημένο	Μαλακό
	Μελιτζάνα	-	-	-	Καλοψημένο
	Ντομάτα	-	-	Μαλακό καλοψημένο	Μαλακό
	Χοιρινό	-	-	Μέτριο προς καλοψημένο	Καλοψημένο
	Προμαγειρεμένα Λουκάνικα	-	-	-	Μαλακό
	Αρνί	-	Μέτριο	Μέτριο προς καλοψημένο	Καλοψημένο
	Φυτική μπιριζόλα	-	-	-	Μαλακό

## ΣΥΜΒΟΥΛΕΣ ΨΗΣΙΜΑΤΟΣ

ΠΡΟΪΟΝΤΑ	ΠΡΟΓΡΑΜΜΑ ΨΗΣΙΜΑΤΟΣ	ΣΥΜΒΟΥΛΗ ΨΗΣΙΜΑΤΟΣ
Χοιρινό φιλέτο (χωρίς κόκκαλο), χοιρινή κοιλιά		Καλοψημένο *
Λουκάνικα Φρανκφούρτης (προψημένο χοιρινό)		220°C / 8 λεπτά 30
Λουκάνικα Rindswurst (προψημένο μοσχάρι)		220°C / 8 λεπτά 30
Λουκάνικα Nürnberg (προψημένο χοιρινό)		220°C / 4 λεπτά 30

## ΕΙΔΙΚΗ ΧΕΙΡΟΚΙΝΗΤΗ ΛΕΙΤΟΥΡΓΙΑ

### ΛΑΧΑΝΙΚΑ Η ΦΡΟΥΤΑ

From 180°C to 195°C	From 220°C to 235°C	From 225°C to 270°C
-	-	Κολοκύθι (φέτες)
-	-	Σπαράγγια
-	-	Μανιτάρια
-	Κρεμμύδι	-
Μπρόκολο	-	-
Καρότα baby	-	-
-	Μάραθος	-
Γλυκοπατάτα (φέτες)	-	-
-	Πατάτα (φέτες)	-
-	Ανανάς	-
-	Ροδάκινο	-

## ΣΥΜΒΟΥΛΕΣ ΠΑΡΑΣΚΕΥΗΣ

Για να έχουν τα ψητά τις χαρακτηριστικές ρίγες από το ψήσιμο, είναι καλό να γυρίσετε το ψημένο κομμάτι πριν το σερβίρετε.

ΠΡΟΪΟΝΤΑ	ΣΥΜΒΟΥΛΕΣ ΠΑΡΑΣΚΕΥΗΣ
ΠΑΤΑΤΑ	<ul style="list-style-type: none"><li>• Φέτες κατά μήκος</li><li>• Προσθέστε λάδι στα υλικά για να ψηθούν καλύτερα</li></ul>
ΠΙΠΕΡΙΑ	<ul style="list-style-type: none"><li>• Κομμένη στα δύο κατά μήκος</li></ul>
ΜΕΛΙΤΖΑΝΑ	<ul style="list-style-type: none"><li>• Φέτες κατά μήκος</li><li>• Προσθέστε λάδι στα υλικά για να ψηθούν καλύτερα</li></ul>
ΝΤΟΜΑΤΑ	<ul style="list-style-type: none"><li>• Χρησιμοποιήστε στρογγυλές ντομάτες</li><li>• Μη χρησιμοποιήσετε πολύ ώριμες ντομάτες</li><li>• Κόψτε στα δύο κατά πλάτος</li><li>• Για βέλτιστο ψήσιμο, τοποθετήστε τη στρογγυλή πλευρά κάθε κομμένης ντομάτας στην κάτω πλάκα της ψηστιέρας.</li></ul>
ΧΟΙΡΙΝΟ	* Χρησιμοποιήστε τη λειτουργία θωράκισης, αν το πάχος του κομματιού είναι πάνω από 20 χιλιοστά.

## TEFAL/T-FAL INTERNATIONAL GUARANTEE: COUNTRY LIST





SMALL HOUSEHOLD APPLIANCES

www.tefal.com

			
ARGENTINA	0800-122-2732	2 años 2 years	GRUPE SEB ARGENTINA S.A. Billinghurst 1833 3° C1425DTK Capital Federal Buenos Aires
ՀԱՅԱՍՏԱՆ ARMENIA	010 55-76-07	2 տարի 2 years	«SEB Ուկրաինա խումբ» ընկերություն Խարկովի խճուղի, 201-203, 3-րդ հարկ Կիևի, 02121 Ուկրաինա 2 տարի
AUSTRALIA	1300307824	1 year	Groupe SEB Australia PO Box 404 North Ryde, NSW, 1670
ÖSTERREICH AUSTRIA	01 890 3476	2 Jahre 2 years	GRUPE SEB DEUTSCHLAND GmbH Theodor-Stern-Kai 1 60596 Frankfurt
البحرين BAHRAIN	17716666	1 year	www.tefal-me.com
БЕЛАРУСЬ BELARUS	017 2239290	2 года 2 years	ЗАО «Группа СЕБ-Восток», Москва, 125171, Ленинградское шоссе, д. 16А, строение 3, помещение XII
BELGIQUE BELGIE BELGIUM	070 23 31 59	2 ans 2 jaar 2 years	GRUPE SEB BELGIUM SA NV 25 avenue de l'Espérance - ZI 6220 Fleurus
BOSNA I HERCEGOVINA	Info-linija za potrošače 033 551 220	2 godine 2 years	SEB Developpement Predstavništvo u BiH Valtera Perića 6/I 71000 Sarajevo
BRASIL BRAZIL	11 2915-4400	1 ano 1 year	Seb Comercial gAv Jornalista Roberto Marinho, 85, 19º andar 04576 – 010 São Paulo - SP
БЪЛГАРИЯ BULGARIA	0700 10 330	2 години 2 years	Груп Себ България ЕООД бул. България 58 С, ет 9, офис 30 1680 София
CANADA	1-800-418-3325	1 an 1 year	Groupe SEB Canada Inc. 36 Newmill Gate, Unit 2 Scarborough, ON M1V 0E2
CHILE	02 2 884 46 06	2 años 2 years	GRUPE SEB CHILE Comercial Ltda Avenida Santa María 0858, Providencia - Santiago
COLOMBIA	018000520022	2 años 2 years	GRUPE SEB COLOMBIA Apartado Aereo 172, Kilometro 1 Via Zipaquirá Cajica Cundinamarca
HRVATSKA CROATIA	01 30 15 294	2 godine 2 years	SEB mku & p d.o.o. Sarajevska 29, 10000 Zagreb
ČESKÁ REPUBLIKA CZECH REPUBLIC	731 010 111	2 roky 2 years	Groupe SEB ČR s.r.o. Futura Business Park (budova A) Sokolovská 651/136a 186 00 Praha 8
DANMARK DENMARK	43 350 350	2 år 2 years	Groupe SEB Denmark A/S Delta Park 37, 3. sal 2665 Vallensbæk Strand
مصر EGYPT	16622	سنة واحدة 1year	جروب سب ايجيبت القاهرة: ١٢١ شارع الحجاز، مصر الجديدة الإسكندرية: طريق ٤ مايو، سموحة

			
<b>EESTI ESTONIA</b>	668 1286	2 aastat 2 years	Groupe SEB Polska Sp. z o.o. Gdański Business Center II D ul. Inflancka 4C 00-189 Warsaw
<b>SUOMI FINLAND</b>	09 8946 150	2 vuotta 2 years	Groupe SEB Finland OY Pakkalankuja 6 01510 Vantaa
<b>FRANCE Continentale + Guadeloupe, Martinique, Réunion, St-Martin</b>	09 74 50 47 74	2 ans 2 years	GRUPE SEB France Service Consommateur Tefal 112 Ch. Moulin Carron, TSA 92002 69134 ECULLY Cedex
<b>DEUTSCHLAND GERMANY</b>	0212 387 400	2 Jahre 2 years	GRUPE SEB DEUTSCHLAND GmbH Theodor-Stern-Kai 1 60596 Frankfurt
<b>ELLADA GREECE</b>	2106371251	2 χρόνια 2 years	SEB GROUPE ΕΛΛΑΔΟΣ Α.Ε. Καβαλιεράτου 7 Τ.Κ. 145 64 Κ. Κηφισιά
<b>香港 HONG KONG</b>	8130 8998	1 year	SEB ASIA Ltd. 9/F, South Block, Skyway House 3 Sham Mong Road, Tai Kok Tsui, Kowloon Hong-Kong
<b>MAGYARORSZÁG HUNGARY</b>	06 1 801 8434	2 év 2 years	GRUPE SEB CENTRAL-EUROPE Kft. 2040 Budaörs, Puskás Tivadar út 14
<b>INDIA</b>	1860-200-1232	2 years	Groupe SEB India (P) Limited A-25, 1st Floor, Rear Tower, Mohan Cooperative Industrial Suites, Mathura Road, New Delhi- 110044
<b>INDONESIA</b>	+62 21 5793 7007	1 year	GRUPE SEB INDONESIA (Representative office) Sudirman Plaza, Plaza Marein 8th Floor JL Jendral Sudirman Kav 76-78, Jakarta 12910, Indonesia
<b>ITALIA ITALY</b>	1 99 207 354	2 anni 2 years	GRUPE SEB ITALIA S.p.A. Via Montefeltro, 4 20156 Milano
<b>日本 JAPAN</b>	0570-077772	1年 1 year	株式会社グループセブジャパン 〒144-0042 東京都大田区羽田旭町11-1 羽田クロノゲート事務棟5F
<b>الأردن JORDAN</b>	5665505	1 year	www.tefal-me.com
<b>ҚАЗАҚСТАН KAZAKHSTAN</b>	727 378 39 39	2 жыл 2 years	ЖАҚ "ГРУППА СЕБ-ВОСТОК", Мәскеу, 125171, Ленинград тас жолы, 16А үй, 3- құрылыс, XII-ғимарат
<b>한국어 KOREA</b>	080-733-7878	1 year	(유)그룹 세브 코리아 서울특별시 종로구 종로1길 50, 더케이트윈타워 B동 14층 03142
<b>الكويت KUWAIT</b>	1807777 Ext :2104	1 year	www.tefal-me.com
<b>LATVJA LATVIA</b>	6 616 3403	2 gadi 2 years	Groupe SEB Polska Sp. z o.o. Gdański Business Center II D ul. Inflancka 4C 00-189 Warsaw
<b>لبنان LEBANON</b>	4414727	1 year	www.tefal-me.com
<b>LIETUVA LITHUANIA</b>	5 214 0057	2 metai 2 years	Groupe SEB Polska Sp. z o.o. Gdański Business Center II D ul. Inflancka 4C 00-189 Warsaw



			
LUXEMBOURG	0032 70 23 31 59	2 ans 2 years	GRUPE SEB BELGIUM SA NV 25 avenue de l'Espérance - ZI 6220 Fleurus
МАКЕДОНИЈА MACEDONIA	(02) 20 50 319	2 години 2 years	Груп Себ България ЕООД бул. България 58 С, ет 9, офис 30 1680 София
MALAYSIA	603 7802 3000	2 years	GRUPE SEB MALAYSIA SDN. BHD Unit No. 402-403, Level 4, Uptown 2, No. 2, Jalan SS21/37, Damansara Uptown, 47400, Petaling Jaya, Selangor D.E Malaysia
MEXICO	(55) 52839354	1 año 1 year	Groupe Seb México S.A. de C.V. Calle Boulevard Miguel de Cervantes, Saavedra No 169 Piso 9, Col Ampliación Granada, C.P. 11520, Ciudad de México
NEDERLAND The Netherlands	0318 58 24 24	2 jaar 2 years	GRUPE SEB NEDERLAND B.V. De Schutterij 27 3905 PK Veenendaal
NEW ZEALAND	0800 700 711	1 year	GRUPE SEB NEW ZEALAND PO Box 17 – 298, Greenlane, 1546 Auckland New Zealand
NORGE NORWAY	22 96 39 30	2 år 2 years	Groupe SEB Norway AS Lilleakerveien 6d, 5 etg 0283, Oslo
سلطنة عمان OMAN	24703471	1 year	www.tefal-me.com
POLSKA POLAND	801 300 420 koszt jak za połączenie lokalne	2 lata 2 years	Groupe SEB Polska Sp. z o.o. Gdański Business Center II D ul. Inflancka 4C 00-189 Warsaw
PORTUGAL	808 284 735	2 anos 2 years	GRUPE SEB IBÉRICA SA Urb. da Matinha Rua Projectada à Rua 3 Bloco1 - 3º B/D 1950 - 327 Lisboa
قطر QATAR	44485555	1 year	www.tefal-me.com
REPUBLIC OF IRELAND	01 677 4003	2 years	GRUPE SEB IRELAND Unit B3 Aerodrome Business Park, College Road, Rathcoole, Co. Dublin
ROMANIA	0 21 316 87 84	2 ani 2 years	GRUPE SEB ROMÂNIA Str. Ermil Pangratti nr. 13 011881 Bucureşti
РОССИЯ RUSSIA	495 213 32 30	2 года 2 years	ЗАО «Группа СЕБ-Восток», Москва, 125171, Ленинградское шоссе, д. 16А, строение 3, помещение XII
المملكة العربية السعودية SAUDI ARABIA	920023701	2 years	www.tefal-me.com
SRBIJA SERBIA	060 0 732 000	2 godine 2 years	SEB Développement Đorđa Stanojevića 11b 11070 Novi Beograd
SINGAPORE	6550 8900	2 years	GRUPE SEB (Singapore) Pte. Ltd. 3A International Business Park #12-04/05, ICON@IBP Singapore 609935
SLOVENSKO SLOVAKIA	232 199 930	2 roky 2 years	GRUPE SEB Slovensko, spol. s r.o. Cesta na Senec 2/A 821 04 Bratislava
SLOVENIJA SLOVENIA	02 234 94 90	2 leti 2 years	GRUPE SEB Slovensko, spol. s r.o. Cesta na Senec 2/A 821 04 Bratislava



FR	2-24
NL	25-47
DE	48-70
EN	71-91
IT	92-114
ES	115-137
PT	138-160
EL	161-182