

X NANO

INSTRUCTIONS FOR USE

KO 사용자 가이드 - TH คำแนะนำในการใช้งาน - MY Panduan pengguna
HK 用戶指南 - CN 用戶指南

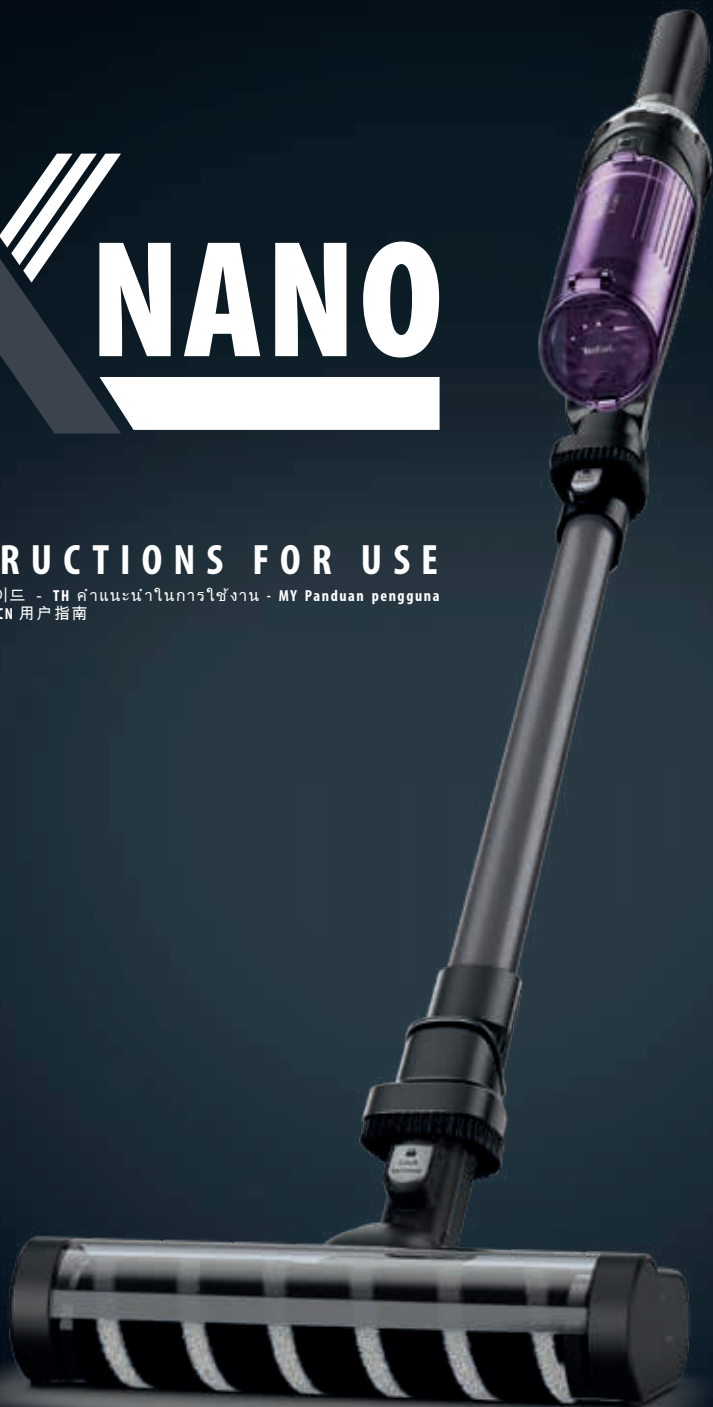

TY113X

PLEASE READ CAREFULLY

THE "SAFETY AND USE INSTRUCTIONS" BOOKLET BEFORE FIRST USE

KO 제품을 처음 사용하기 전에 "안전 주의사항과 사용 방법"에 대한 안내 책자를 주의 깊게 읽으시기 바랍니다
 TH โปรดอ่านคู่มือ "คำแนะนำด้านความปลอดภัยและการใช้งาน" โดยละเอียดก่อนใช้งานครั้งแรก
 MY Sila baca buku arahan keselamatan tengeran teliti sebelum penggunaan pertama
 HK 第一次使用前, 請仔細閱讀"安全使用說明"小冊子
 CN 请在初次使用本产品前仔细阅读"安全及使用说明"



- 1 **EASY WASH FILTER** - KO 세척이 쉬운 필터 / TH ไล้กรองล้างทำความสะอาดง่าย / MY Penapis mudah dicuci / HK 簡易清洗過濾芯 / CN 容易清洗过滤器
- 2 **SEPARATOR** - KO 먼지 분리기 / TH ตัวแยก / MY Pemisah / HK 分隔器 / CN 分隔器
- 3 **DUST CONTAINER** - KO 먼지통 / TH ถังเก็บฝุ่น / MY Bekas habuk / HK 集塵箱 / CN 集尘箱
- 4 **REMOVABLE BATTERY** - KO 분리형 배터리 / TH แบตเตอรี่แบบถอดออกได้ / MY Bateri yang boleh ditanggalkan / HK 可替換式電池 / CN 可替換式電池
- 5 **CHARGING BASE** - KO 충전 거치대 / TH แท่นชาร์จ / MY Asas pengecasan / HK 充電插座 / CN 充電插座
- 6 **CREVICE NOZZLE** - KO 틈새 브러시 노즐 / TH หัวดูดปากแคบ / MY Muncung celah / HK 縫隙吸嘴 / CN 窄縫吸嘴
- 7 **STAND** - KO 거치대 / TH ขาตั้ง / MY Berdiri / HK 收納架 / CN 收納架
- 8 **DETACHABLE HOLDER** - KO 미끄럼 방지 홀더 / TH ที่จับแบบถอดออกได้ / MY Pemegang boleh tanggal / HK 可拆式固定器 / CN 可拆式固定器



* EN Depending on model / KO 거치대 및 미끄럼 방지 홀더 포함 여부는 모델에 따라 다름 / TH ขึ้นอยู่กับรุ่น / MY Bergantung pada model / HK 根據型號 / CN 根據不同型號

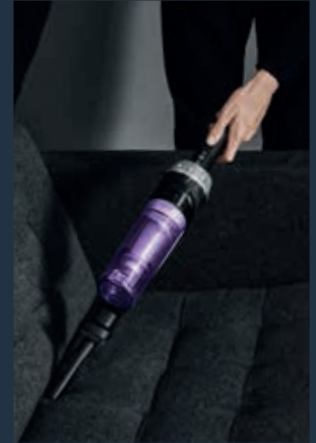
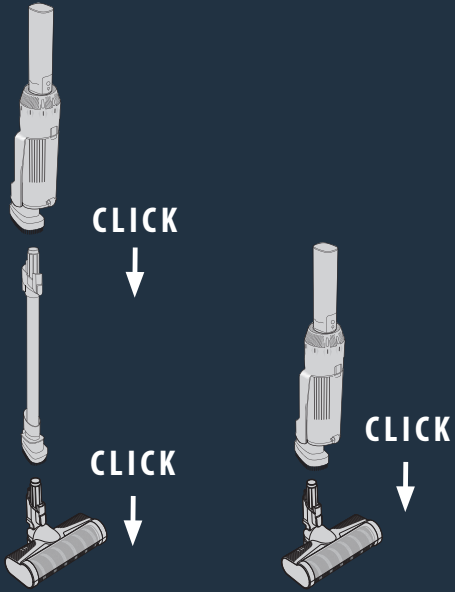

	 ON	BOOST
	UP TO 40 min	UP TO 14 min
	UP TO 25 min	UP TO 13 min

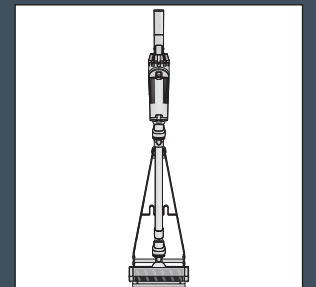
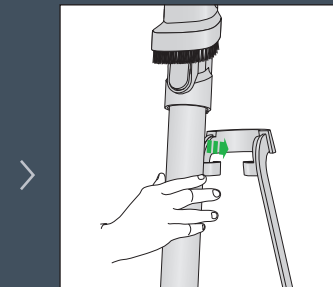
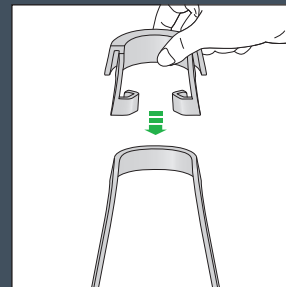
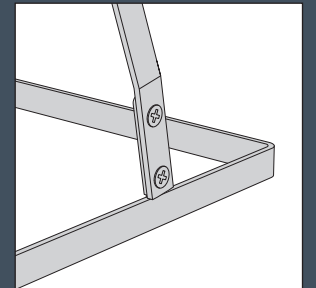
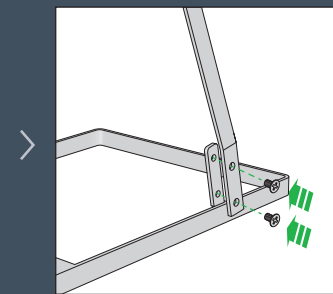
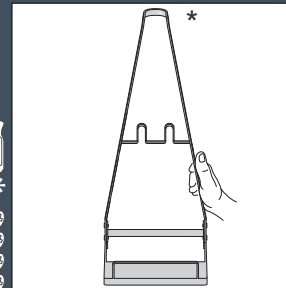
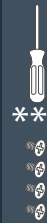

* EN Depending on model / KO 거치대 포함 여부는 모델에 따라 다름 / TH ขึ้นอยู่กับรุ่น / MY Bergantung pada model / HK 根據型號 / CN 根据不同型号
 ** EN Screwdriver is not included / KO 드라이버는 구성품에 포함되지 않음 / TH ไม่มีส่วนประกอบให้ / MY Pemutar skru tidak disertakan / HK 不包括螺絲批 / CN 不包括螺丝刀



A

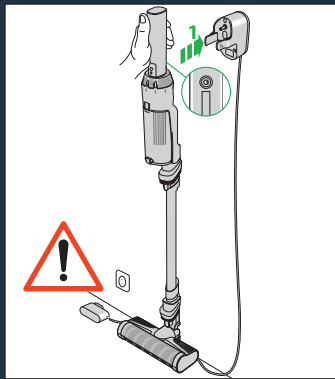

A.1

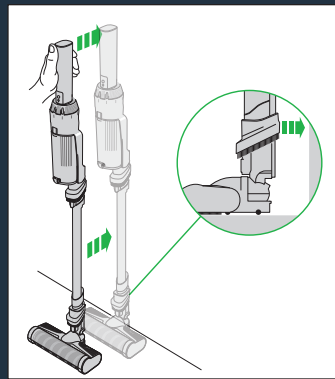

A.2

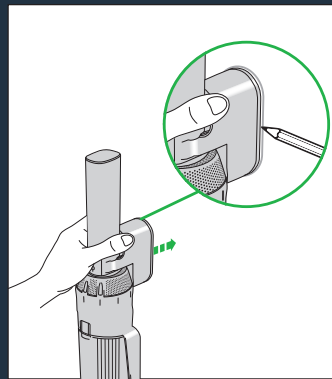

A.3

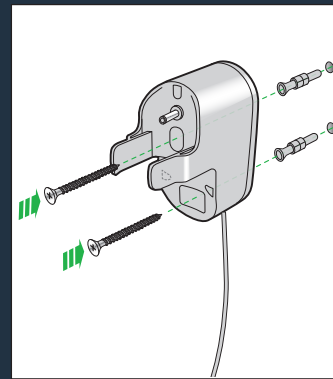

A.4

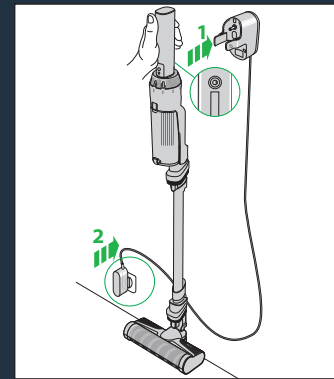

A.5

B

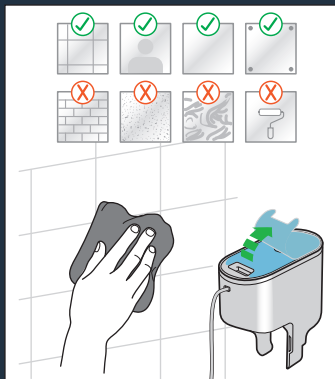

B.1

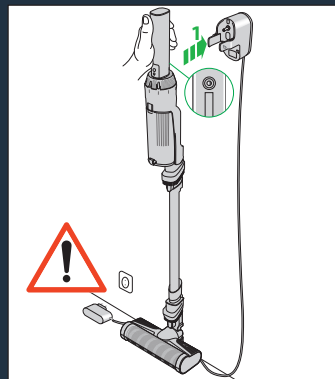

B.2

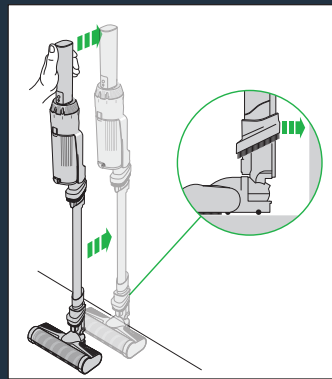

B.3

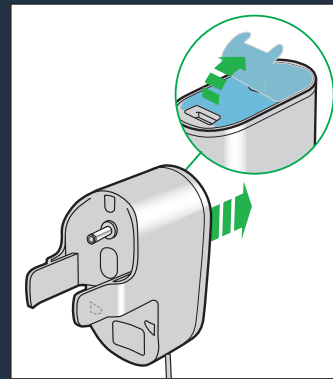

B.4

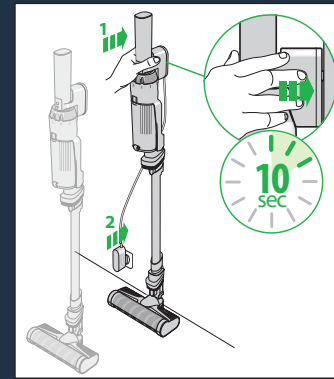

B.5

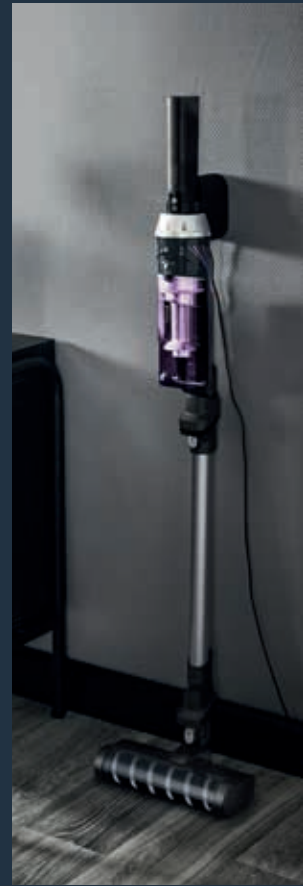

* EN Drill, screwdriver and screws are not included / KO 드릴과 나사, 드라이버는 구성품에 포함되지 않음
TH ไม่มีสว่าน ไขควง และสกรูแถมมาให้ / MY Gerudi, pemutar skru dan skru tidak disertakan / HK 不包括鑽孔機、螺絲批和螺絲
CN 不包括钻头、螺丝刀和螺丝

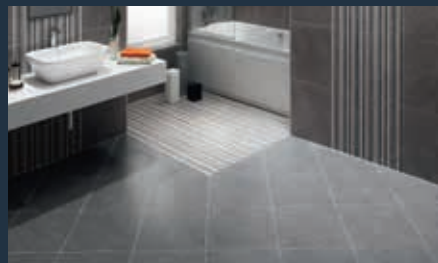
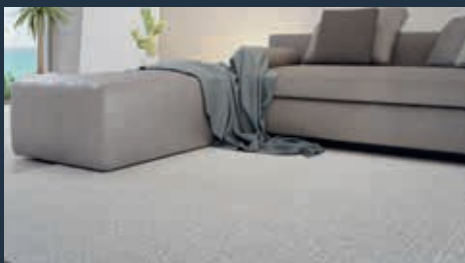

ON / OFF

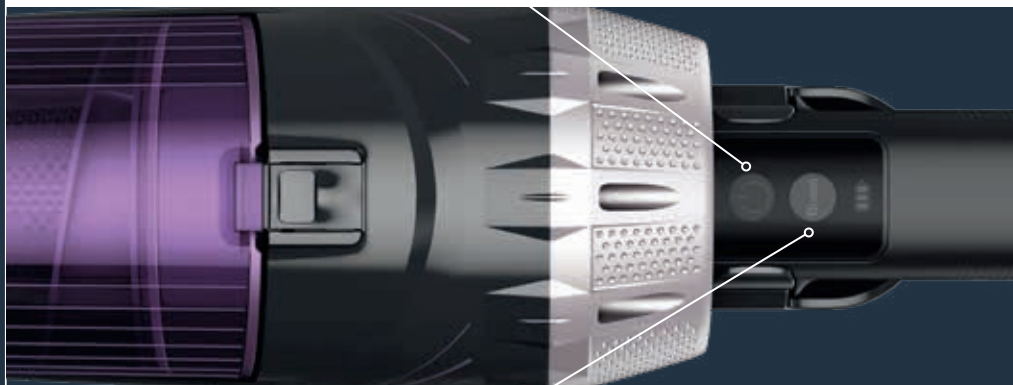

BOOST

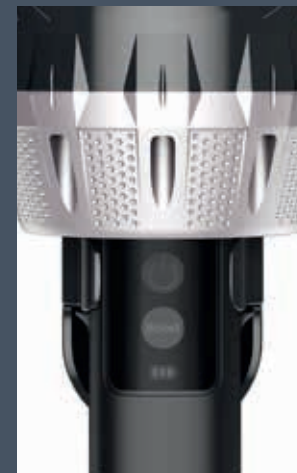
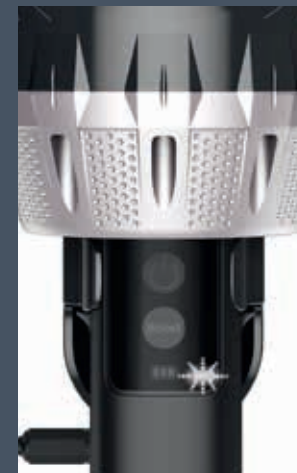
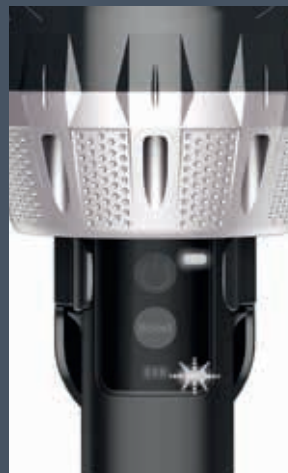

ON

BOOST

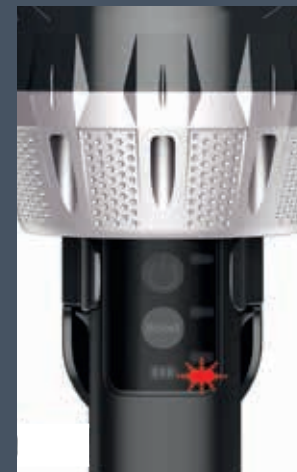
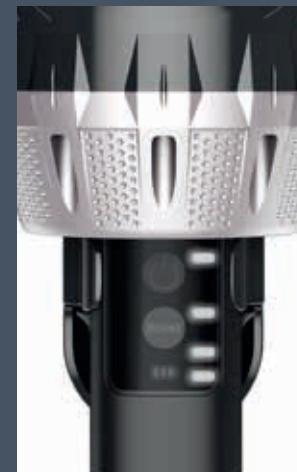
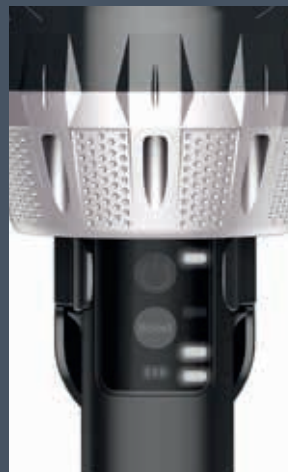



1X / WEEK* - * KO 주 - TH สัปดาห์ - MY Minggu - HK 星期 - CN 星期

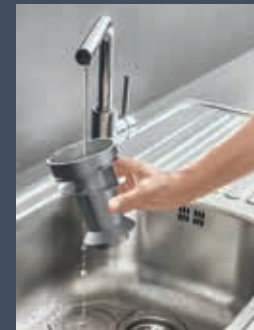
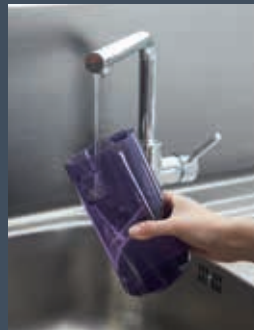
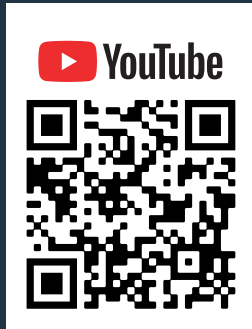



EASY WASH

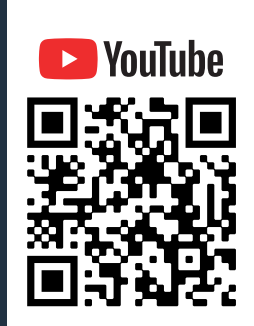

1X / WEEK* - * KO 주 - TH สัปดาห์ - MY Minggu - HK 星期 - CN 星期



2X / YEAR* - * KO 년 - TH ปี - MY Tahun - HK 年 - CN 年



1X / WEEK* - * KO 주 - TH สัปดาห์ - MY Minggu - HK 星期 - CN 星期

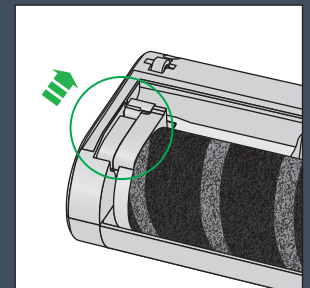
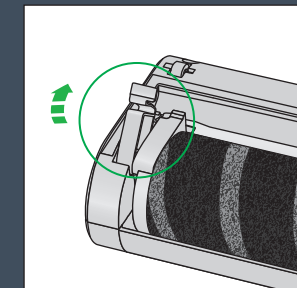
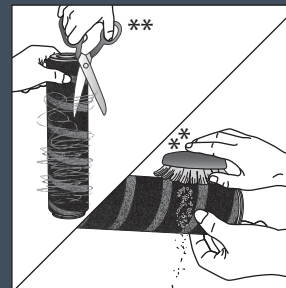
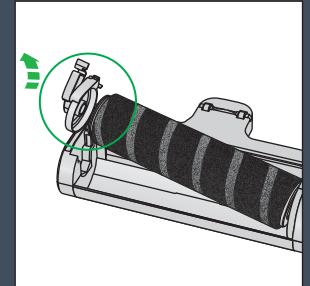
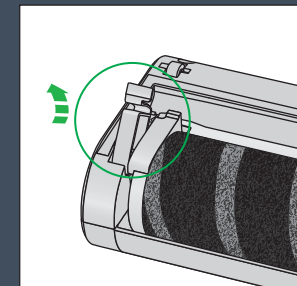
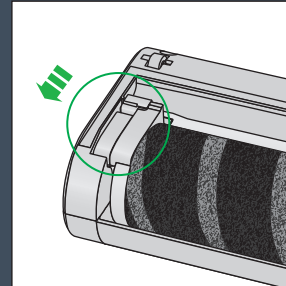
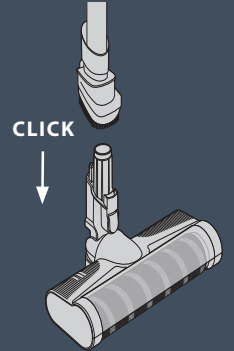
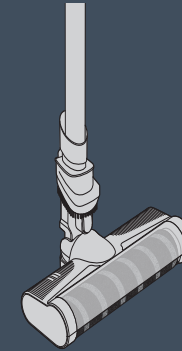

* EN Scissors and brush are not included / KO 가위와 브러시는 구성품에 포함되지 않음 / TH ไม่มีกรรไกรและแปรงแถมมาให้ / MY Gunting dan berus tidak disertakan / HK 不包括剪刀和刷子 / CN 不包括剪刀和刷子

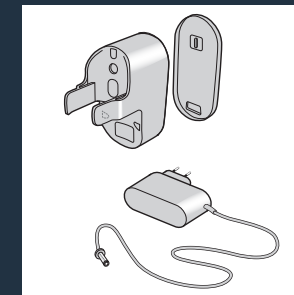
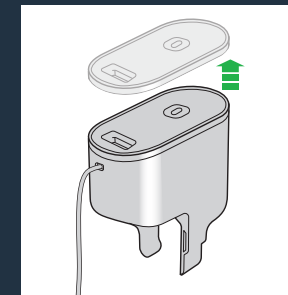
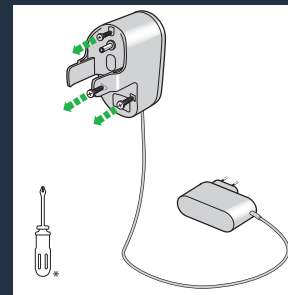
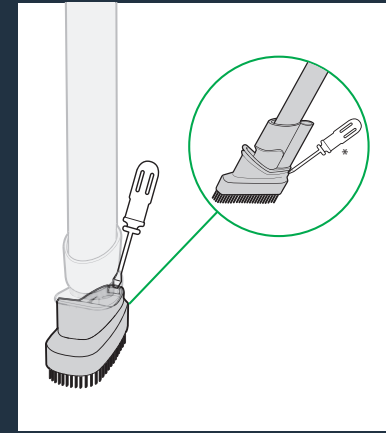
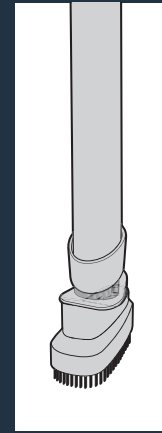
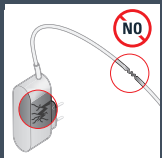
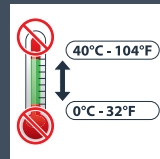
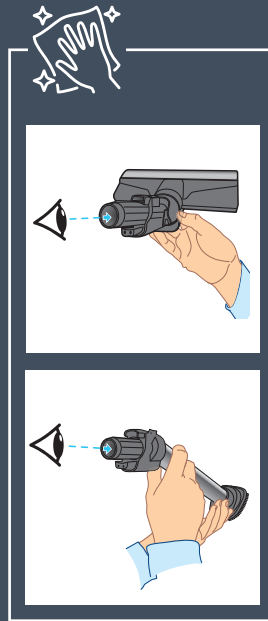
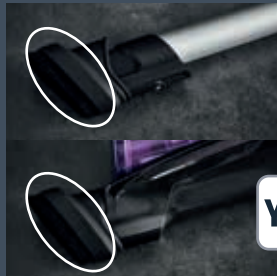
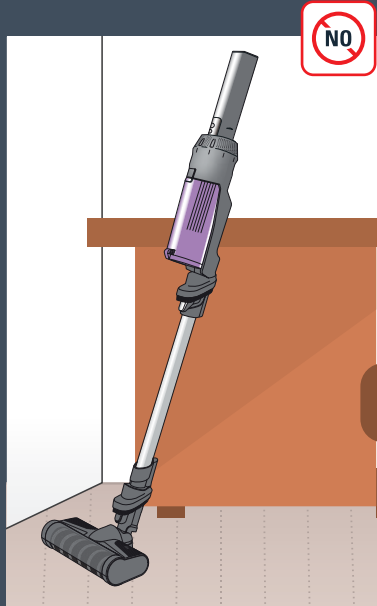

* EN Scissors and brush are not included / KO 트라이버는 구성품에 포함되지 않음 / TH ไม่มีกรรไกรและแปรงแถมมาให้ / MY Gunting dan berus tidak disertakan / HK 不包括剪刀和刷子 / CN 不包括剪刀和刷子

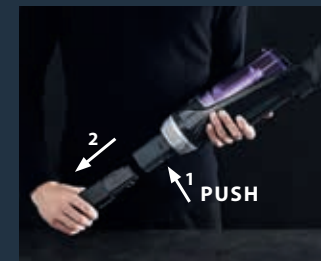
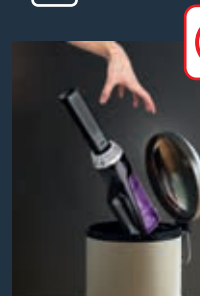

** EN Dispose the battery in accordance with local laws and local arrangements. If you have any questions, please contact your product dealer who can tell you what to do. / KO 현지 법률 및 현지 규정에 따라 배터리를 폐기하십시오. 배터리 폐기 관련 궁금한 점은 제품 구입처 또는 데팔 고객센터로 문의하십시오. / TH ที่รับแบตเตอรี่ตามกฎหมายท้องถิ่นและข้อตกลงของท้องถิ่น ถ้ามีข้อสงสัย โปรดติดต่อตัวแทนจำหน่ายผลิตภัณฑ์ของคุณที่จะบอกคุณว่าควรทำอย่างไร / MY Buang bateri mengikut undang-undang tempatan dan pengaturann tempatan. Jika anda mempunyai sebarang pertanyaan, sila hubungi pengedar produk anda yang boleh memberitahu anda perkara yang perlu dilakukan. / HK 請根據當地法律和當地安排處置電池。如有任何疑問，請聯絡您的產品經銷商，他們可以告訴您該怎么做。 / CN 請根據當地法律和當地安排處置電池。如有任何疑問，請聯系您的產品經銷商，他們可以告訴您該怎么做。



KO 전 세계 6,200개 승인된
수리업체를 통해 15년 동안
합리적인 비용으로 수리 가능

HK 15年實惠的維修價格。全球
有 6200 位經核准的維修商

TH อะไหล่มีให้ซ่อมแซมเป็นระยะ
เวลา 15 ปี ซ่อมแซมได้ในราคา
ยุติธรรม ศูนย์ซ่อม 6,200 รายที่
ได้รับอนุมัติทั่วโลก

CN 15年实惠的维修价格。
全球有 6200 位经核准的维
修商



MY R boleh dipasang pada harga wajar
15 tahun. BOLEH DIBAIKI PADA HARGA
YANG BERPATUTAN. 6200 PEMBAIK YANG
DILULUSKAN DI SELURUH DUNIA

FOR MORE INFORMATION, PLEASE VISIT THE BELOW WEBSITE.

KO 더 자세한 정보는 아래 웹사이트에서 확인하실 수 있습니다 / TH สำหรับข้อมูลเพิ่มเติม โปรดไปที่เว็บไซต์ด้านล่าง /
MY Untuk maklumat selanjutnya / HK 如欲了解更多信息，可瀏覽以下網址 / CN 如欲了解更多信息，可浏览以下网址

www.tefal.com

2220005951-03 - 6/2024